

## Chapter One

### Section 1.1

1.

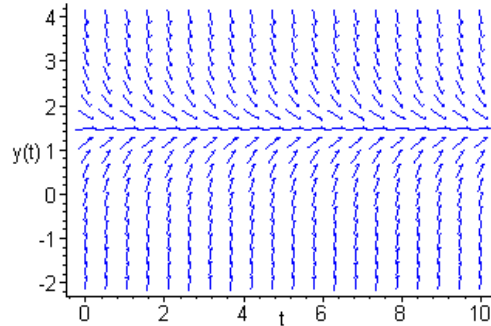

For  $y > 1.5$ , the slopes are *negative*, and hence the solutions decrease. For  $y < 1.5$ , the slopes are *positive*, and hence the solutions increase. The equilibrium solution appears to be  $y(t) = 1.5$ , to which all other solutions converge.

3.

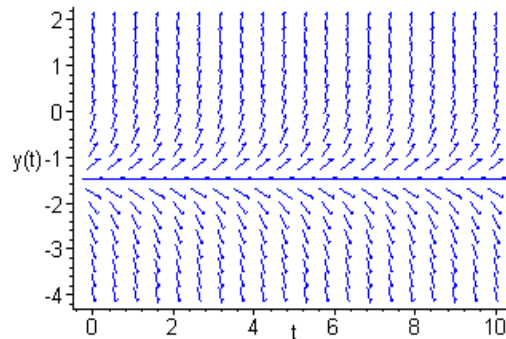

For  $y > -1.5$ , the slopes are *positive*, and hence the solutions increase. For  $y < -1.5$ , the slopes are *negative*, and hence the solutions decrease. All solutions appear to diverge away from the equilibrium solution  $y(t) = -1.5$ .

5.

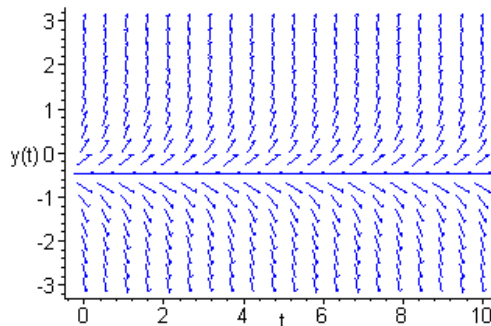

For  $y > -1/2$ , the slopes are *positive*, and hence the solutions increase. For  $y < -1/2$ , the slopes are *negative*, and hence the solutions decrease. All solutions diverge away from

the equilibrium solution  $y(t) = -1/2$ .

6.

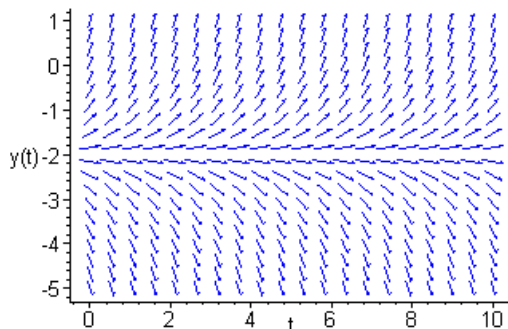

For  $y > -2$ , the slopes are *positive*, and hence the solutions increase. For  $y < -2$ , the slopes are *negative*, and hence the solutions decrease. All solutions diverge away from the equilibrium solution  $y(t) = -2$ .

8. For *all* solutions to approach the equilibrium solution  $y(t) = 2/3$ , we must have  $y' < 0$  for  $y > 2/3$ , and  $y' > 0$  for  $y < 2/3$ . The required rates are satisfied by the differential equation  $y' = 2 - 3y$ .

9. For solutions *other* than  $y(t) = 2$  to diverge from  $y = 2$ ,  $y(t)$  must be an *increasing* function for  $y > 2$ , and a *decreasing* function for  $y < 2$ . The simplest differential equation whose solutions satisfy these criteria is  $y' = y - 2$ .

10. For solutions *other* than  $y(t) = 1/3$  to diverge from  $y = 1/3$ , we must have  $y' < 0$  for  $y < 1/3$ , and  $y' > 0$  for  $y > 1/3$ . The required rates are satisfied by the differential equation  $y' = 3y - 1$ .

12.

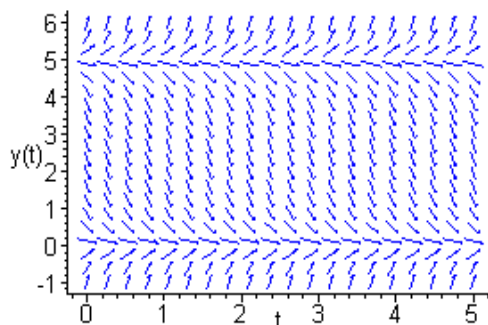

Note that  $y' = 0$  for  $y = 0$  and  $y = 5$ . The two equilibrium solutions are  $y(t) = 0$  and  $y(t) = 5$ . Based on the direction field,  $y' > 0$  for  $y > 5$ ; thus solutions with initial values *greater* than 5 diverge from the solution  $y(t) = 5$ . For  $0 < y < 5$ , the slopes are *negative*, and hence solutions with initial values *between* 0 and 5 all decrease toward the

solution  $y(t) = 0$ . For  $y < 0$ , the slopes are all *positive*; thus solutions with initial values less than 0 approach the solution  $y(t) = 0$ .

14.

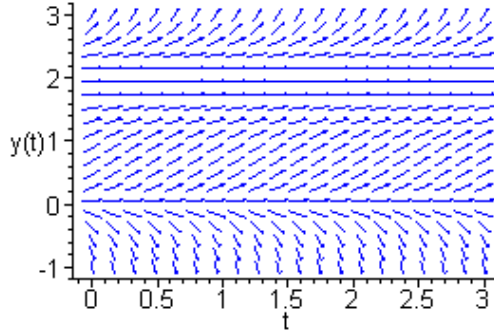

Observe that  $y' = 0$  for  $y = 0$  and  $y = 2$ . The two equilibrium solutions are  $y(t) = 0$  and  $y(t) = 2$ . Based on the direction field,  $y' > 0$  for  $y > 2$ ; thus solutions with initial values *greater* than 2 diverge from  $y(t) = 2$ . For  $0 < y < 2$ , the slopes are also *positive*, and hence solutions with initial values *between* 0 and 2 all increase toward the solution

$y(t) = 2$ . For  $y < 0$ , the slopes are all *negative*; thus solutions with initial values less than 0 diverge from the solution  $y(t) = 0$ .

16. (a) Let  $M(t)$  be the total amount of the drug (*in milligrams*) in the patient's body at any given time  $t$  (*hrs*). The drug is administered into the body at a *constant* rate of 500 *mg/hr*.

The rate at which the drug *leaves* the bloodstream is given by  $0.4M(t)$ . Hence the accumulation rate of the drug is described by the differential equation

$$\frac{dM}{dt} = 500 - 0.4M \quad (\text{mg/hr}).$$

(b)

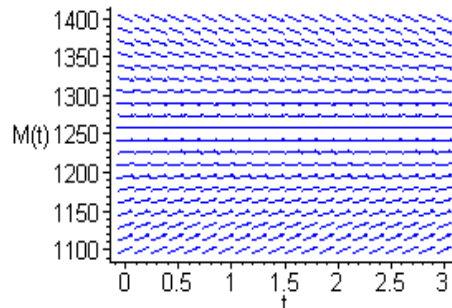

Based on the direction field, the amount of drug in the bloodstream approaches the equilibrium level of 1250 *mg* (*within a few hours*).

18. (a) Following the discussion in the text, the differential equation is

$$m \frac{dv}{dt} = mg - \gamma v^2$$

or equivalently,

$$\frac{dv}{dt} = g - \frac{\gamma}{m} v^2.$$

(b) After a long time,  $\frac{dv}{dt} \approx 0$ . Hence the object attains a *terminal velocity* given by

$$v_{\infty} = \sqrt{\frac{mg}{\gamma}}.$$

(c) Using the relation  $\gamma v_{\infty}^2 = mg$ , the required *drag coefficient* is  $\gamma = 0.0408 \text{ kg/sec}$ .

(d)

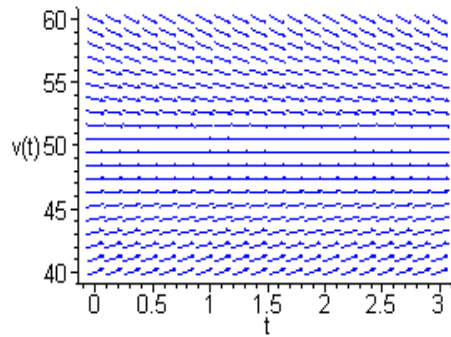

19.

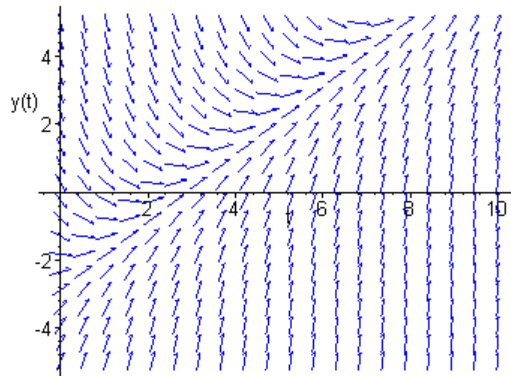

All solutions appear to approach a linear asymptote (*with slope equal to 1*). It is easy to verify that  $y(t) = t - 3$  is a solution.

20.

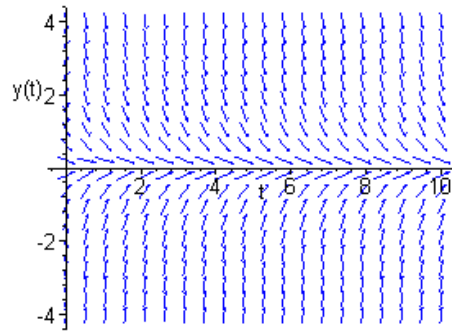

All solutions approach the equilibrium solution  $y(t) = 0$ .

23.

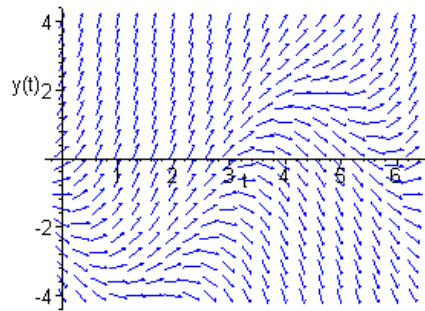

All solutions appear to *diverge* from the sinusoid  $y(t) = -\frac{3}{\sqrt{2}}\sin(t + \frac{\pi}{4}) - 1$ , which is also a solution corresponding to the initial value  $y(0) = -5/2$ .

25.

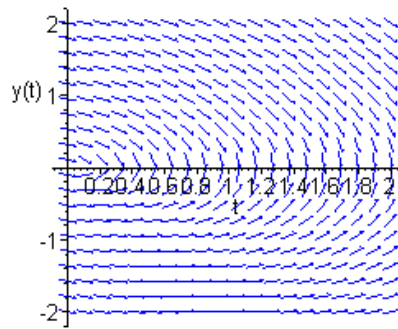

All solutions appear to converge to  $y(t) = 0$ . First, the rate of change is small. The slopes eventually increase very rapidly in *magnitude*.

26.

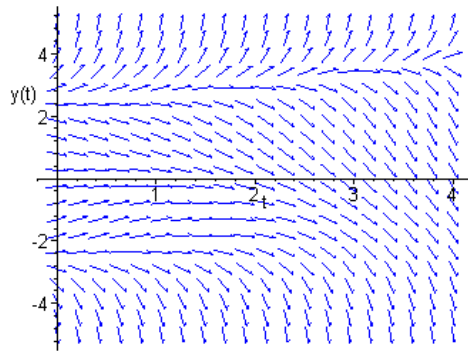

The direction field is rather complicated. Nevertheless, the collection of points at which the slope field is *zero*, is given by the implicit equation  $y^3 - 6y = 2t^2$ . The graph of these points is shown below:

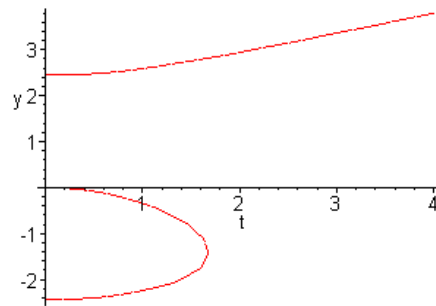

The *y*-intercepts of these curves are at  $y = 0, \pm\sqrt{6}$ . It follows that for solutions with initial values  $y > \sqrt{6}$ , all solutions increase without bound. For solutions with initial values in the range  $y < -\sqrt{6}$  and  $0 < y < \sqrt{6}$ , the slopes remain *negative*, and hence these solutions decrease without bound. Solutions with initial conditions in the range  $-\sqrt{6} < y < 0$  initially increase. Once the solutions reach the critical value, given by the equation  $y^3 - 6y = 2t^2$ , the slopes become negative and *remain* negative. These solutions eventually decrease without bound.

## Section 1.2

1(a) The differential equation can be rewritten as

$$\frac{dy}{5-y} = dt.$$

Integrating both sides of this equation results in  $-\ln|5-y| = t + c_1$ , or equivalently,  $5-y = ce^{-t}$ . Applying the initial condition  $y(0) = y_0$  results in the specification of the constant as  $c = 5 - y_0$ . Hence the solution is  $y(t) = 5 + (y_0 - 5)e^{-t}$ .

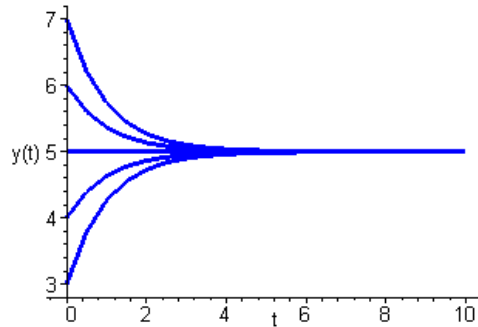

All solutions appear to converge to the equilibrium solution  $y(t) = 5$ .

1(c). Rewrite the differential equation as

$$\frac{dy}{10-2y} = dt.$$

Integrating both sides of this equation results in  $-\frac{1}{2}\ln|10-2y| = t + c_1$ , or equivalently,  $5-y = ce^{-2t}$ . Applying the initial condition  $y(0) = y_0$  results in the specification of the constant as  $c = 5 - y_0$ . Hence the solution is  $y(t) = 5 + (y_0 - 5)e^{-2t}$ .

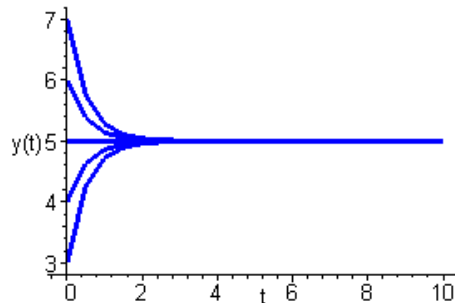

All solutions appear to converge to the equilibrium solution  $y(t) = 5$ , but at a *faster* rate than in Problem 1a.

2(a). The differential equation can be rewritten as

$$\frac{dy}{y-5} = dt.$$

Integrating both sides of this equation results in  $\ln|y-5| = t + c_1$ , or equivalently,  $y-5 = ce^t$ . Applying the initial condition  $y(0) = y_0$  results in the specification of the constant as  $c = y_0 - 5$ . Hence the solution is  $y(t) = 5 + (y_0 - 5)e^t$ .

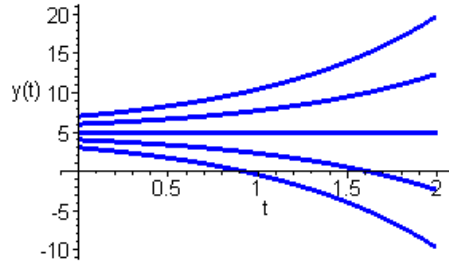

All solutions appear to diverge from the equilibrium solution  $y(t) = 5$ .

2(b). Rewrite the differential equation as

$$\frac{dy}{2y-5} = dt.$$

Integrating both sides of this equation results in  $\frac{1}{2}\ln|2y-5| = t + c_1$ , or equivalently,  $2y-5 = ce^{2t}$ . Applying the initial condition  $y(0) = y_0$  results in the specification of the constant as  $c = 2y_0 - 5$ . Hence the solution is  $y(t) = 2.5 + (y_0 - 2.5)e^{2t}$ .

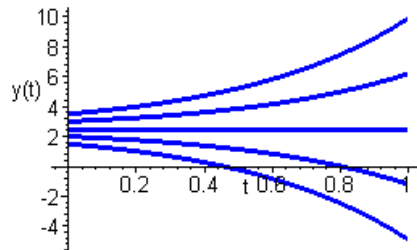

All solutions appear to diverge from the equilibrium solution  $y(t) = 2.5$ .

2(c). The differential equation can be rewritten as

$$\frac{dy}{2y-10} = dt.$$

Integrating both sides of this equation results in  $\frac{1}{2}\ln|2y-10| = t + c_1$ , or equivalently,  $y-5 = ce^{2t}$ . Applying the initial condition  $y(0) = y_0$  results in the specification of the constant as  $c = y_0 - 5$ . Hence the solution is  $y(t) = 5 + (y_0 - 5)e^{2t}$ .



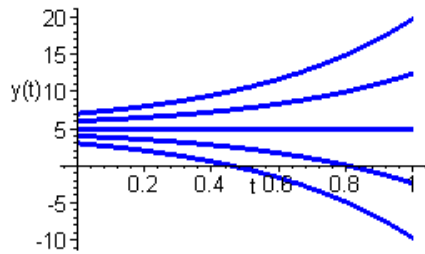

All solutions appear to diverge from the equilibrium solution  $y(t) = 5$ .

3(a). Rewrite the differential equation as

$$\frac{dy}{b - ay} = dt,$$

which is valid for  $y \neq b/a$ . Integrating both sides results in  $-\frac{1}{a} \ln|b - ay| = t + c_1$ , or equivalently,  $b - ay = c e^{-at}$ . Hence the general solution is  $y(t) = (b - c e^{-at})/a$ . Note that if  $y = b/a$ , then  $dy/dt = 0$ , and  $y(t) = b/a$  is an equilibrium solution.

(b)

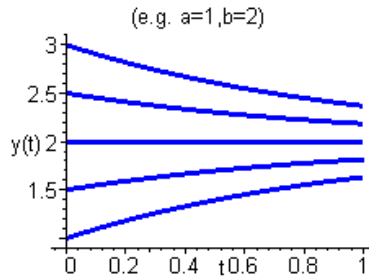

(i) As  $a$  increases, the equilibrium solution gets closer to  $y(t) = 0$ , from above. Furthermore, the *convergence rate* of all solutions, that is,  $a$ , also increases.

(ii) As  $b$  increases, then the equilibrium solution  $y(t) = b/a$  also becomes larger. In this case, the convergence rate remains the same.

(iii) If  $a$  and  $b$  both increase (*but*  $b/a = \text{constant}$ ), then the equilibrium solution  $y(t) = b/a$  remains the same, but the *convergence rate* of all solutions increases.

5(a). Consider the simpler equation  $dy_1/dt = -ay_1$ . As in the previous solutions, rewrite the equation as

$$\frac{dy_1}{y_1} = -a dt.$$

Integrating both sides results in  $y_1(t) = c e^{-at}$ .

(b). Now set  $y(t) = y_1(t) + k$ , and substitute into the original differential equation. We find that

$$-ay_1 + 0 = -a(y_1 + k) + b.$$

That is,  $-ak + b = 0$ , and hence  $k = b/a$ .

(c). The general solution of the differential equation is  $y(t) = ce^{-at} + b/a$ . This is exactly the form given by Eq. (17) in the text. Invoking an initial condition  $y(0) = y_0$ , the solution may also be expressed as  $y(t) = b/a + (y_0 - b/a)e^{-at}$ .

6(a). The general solution is  $p(t) = 900 + ce^{t/2}$ , that is,  $p(t) = 900 + (p_0 - 900)e^{t/2}$ . With  $p_0 = 850$ , the specific solution becomes  $p(t) = 900 - 50e^{t/2}$ . This solution is a *decreasing* exponential, and hence the time of extinction is equal to the number of months

it takes, say  $t_f$ , for the population to reach *zero*. Solving  $900 - 50e^{t_f/2} = 0$ , we find that  $t_f = 2 \ln(900/50) = 5.78$  months.

(b) The solution,  $p(t) = 900 + (p_0 - 900)e^{t/2}$ , is a *decreasing* exponential as long as  $p_0 < 900$ . Hence  $900 + (p_0 - 900)e^{t_f/2} = 0$  has only *one* root, given by

$$t_f = 2 \ln\left(\frac{900}{900 - p_0}\right).$$

(c). The answer in part (b) is a general equation relating time of extinction to the value of

the initial population. Setting  $t_f = 12$  months, the equation may be written as

$$\frac{900}{900 - p_0} = e^6,$$

which has solution  $p_0 = 897.7691$ . Since  $p_0$  is the initial population, the appropriate answer is  $p_0 = 898$  mice.

7(a). The general solution is  $p(t) = p_0 e^{rt}$ . Based on the discussion in the text, time  $t$  is measured in *months*. Assuming 1 month = 30 days, the hypothesis can be expressed as  $p_0 e^{r \cdot 1} = 2p_0$ . Solving for the rate constant,  $r = \ln(2)$ , with units of *per month*.

(b).  $N$  days =  $N/30$  months. The hypothesis is stated mathematically as  $p_0 e^{rN/30} = 2p_0$ .

It follows that  $rN/30 = \ln(2)$ , and hence the rate constant is given by  $r = 30 \ln(2)/N$ . The units are understood to be *per month*.

9(a). Assuming *no air resistance*, with the positive direction taken as *downward*, Newton's Second Law can be expressed as

$$m \frac{dv}{dt} = mg$$

in which  $g$  is the *gravitational constant* measured in appropriate units. The equation can be

written as  $dv/dt = g$ , with solution  $v(t) = gt + v_0$ . The object is released with an initial velocity  $v_0$ .

(b). Suppose that the object is released from a height of  $h$  units above the ground. Using the fact that  $v = dx/dt$ , in which  $x$  is the *downward displacement* of the object, we obtain the differential equation for the displacement as  $dx/dt = gt + v_0$ . With the origin placed at the point of release, direct integration results in  $x(t) = gt^2/2 + v_0 t$ . Based on the chosen coordinate system, the object reaches the ground when  $x(t) = h$ . Let  $t = T$  be the time that it takes the object to reach the ground. Then  $gT^2/2 + v_0 T = h$ . Using the quadratic formula to solve for  $T$ ,

$$T = \frac{-v_0 \pm \sqrt{v_0^2 + 2gh}}{g}.$$

The *positive* answer corresponds to the time it takes for the object to fall to the ground. The *negative* answer represents a previous instant at which the object could have been launched upward (*with the same impact speed*), only to ultimately fall downward with speed  $v_0$ , from a height of  $h$  units above the ground.

(c). The impact speed is calculated by substituting  $t = T$  into  $v(t)$  in part (a). That is,  $v(T) = \sqrt{v_0^2 + 2gh}$ .

10(a,b). The general solution of the differential equation is  $Q(t) = ce^{-rt}$ . Given that  $Q(0) = 100$  mg, the value of the constant is given by  $c = 100$ . Hence the amount of thorium-234 present at any time is given by  $Q(t) = 100 e^{-rt}$ . Furthermore, based on the hypothesis, setting  $t = 1$  results in  $82.04 = 100 e^{-r}$ . Solving for the rate constant, we find that  $r = -\ln(82.04/100) = .19796/\text{week}$  or  $r = .02828/\text{day}$ .

(c). Let  $T$  be the time that it takes the isotope to decay to *one-half* of its original amount.

From part (a), it follows that  $50 = 100 e^{-rT}$ , in which  $r = .19796/\text{week}$ . Taking the natural logarithm of both sides, we find that  $T = 3.5014$  weeks or  $T = 24.51$  days.

11. The general solution of the differential equation  $dQ/dt = -rQ$  is  $Q(t) = Q_0 e^{-rt}$ , in which  $Q_0 = Q(0)$  is the initial amount of the substance. Let  $\tau$  be the time that it takes the substance to decay to *one-half* of its original amount,  $Q_0$ . Setting  $t = \tau$  in the solution,

we have  $0.5 Q_0 = Q_0 e^{-r\tau}$ . Taking the natural logarithm of both sides, it follows that  $-r\tau = \ln(0.5)$  or  $r\tau = \ln 2$ .

12. The differential equation governing the amount of radium-226 is  $dQ/dt = -rQ$ , with solution  $Q(t) = Q(0)e^{-rt}$ . Using the result in Problem 11, and the fact that the half-life  $\tau = 1620$  years, the decay rate is given by  $r = \ln(2)/1620$  per year. The amount of radium-226, after  $t$  years, is therefore  $Q(t) = Q(0)e^{-0.00042786t}$ . Let  $T$  be the time that it takes the isotope to decay to  $3/4$  of its original amount. Then setting  $t = T$ , and  $Q(T) = \frac{3}{4}Q(0)$ , we obtain  $\frac{3}{4}Q(0) = Q(0)e^{-0.00042786T}$ . Solving for the decay time, it follows that  $-0.00042786T = \ln(3/4)$  or  $T = 672.36$  years.

13. The solution of the differential equation, with  $Q(0) = 0$ , is  $Q(t) = CV(1 - e^{-t/CR})$ . As  $t \rightarrow \infty$ , the exponential term vanishes, and hence the limiting value is  $Q_L = CV$ .

14(a). The *accumulation* rate of the chemical is  $(0.01)(300)$  grams per hour. At any given time  $t$ , the *concentration* of the chemical in the pond is  $Q(t)/10^6$  grams per gallon. Consequently, the chemical *leaves* the pond at a rate of  $(3 \times 10^{-4})Q(t)$  grams per hour. Hence, the rate of change of the chemical is given by

$$\frac{dQ}{dt} = 3 - 0.0003Q(t) \text{ gm/hr.}$$

Since the pond is initially free of the chemical,  $Q(0) = 0$ .

(b). The differential equation can be rewritten as

$$\frac{dQ}{10000 - Q} = 0.0003 dt.$$

Integrating both sides of the equation results in  $-\ln|10000 - Q| = 0.0003t + C$ .

Taking

the natural logarithm of both sides gives  $10000 - Q = ce^{-0.0003t}$ . Since  $Q(0) = 0$ , the value of the constant is  $c = 10000$ . Hence the amount of chemical in the pond at any time

is  $Q(t) = 10000(1 - e^{-0.0003t})$  grams. Note that 1 year = 8760 hours. Setting  $t = 8760$ , the amount of chemical present after *one year* is  $Q(8760) = 9277.77$  grams, that is, 9.27777 kilograms.

(c). With the *accumulation* rate now equal to zero, the governing equation becomes  $dQ/dt = -0.0003Q(t)$  gm/hr. Resetting the time variable, we now assign the new initial value as  $Q(0) = 9277.77$  grams.

(d). The solution of the differential equation in Part (c) is  $Q(t) = 9277.77e^{-0.0003t}$ . Hence, one year *after* the source is removed, the amount of chemical in the pond is  $Q(8760) = 670.1$  grams.

(e). Letting  $t$  be the amount of time after the source is removed, we obtain the equation  $10 = 9277.77 e^{-0.0003t}$ . Taking the natural logarithm of both sides,  $-0.0003t = \ln(10/9277.77)$  or  $t = 22,776 \text{ hours} = 2.6 \text{ years}$ .

(f)

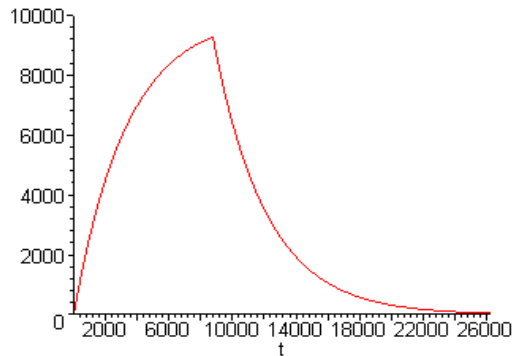

15(a). It is assumed that dye is no longer entering the pool. In fact, the rate at which the dye leaves the pool is  $200 \cdot [q(t)/60000] \text{ kg/min} = 200(60/1000)[q(t)/60] \text{ gm per hour}$ .

Hence the equation that governs the amount of dye in the pool is

$$\frac{dq}{dt} = -0.2q \quad (\text{gm/hr}).$$

The initial amount of dye in the pool is  $q(0) = 5000 \text{ grams}$ .

(b). The solution of the governing differential equation, with the specified initial value, is  $q(t) = 5000 e^{-0.2t}$ .

(c). The amount of dye in the pool after four hours is obtained by setting  $t = 4$ . That is,  $q(4) = 5000 e^{-0.8} = 2246.64 \text{ grams}$ . Since size of the pool is 60,000 gallons, the concentration of the dye is 0.0374 grams/gallon.

(d). Let  $T$  be the time that it takes to reduce the concentration level of the dye to 0.02 grams/gallon. At that time, the amount of dye in the pool is 1,200 grams. Using the answer in part (b), we have  $5000 e^{-0.2T} = 1200$ . Taking the natural logarithm of both sides of the equation results in the required time  $T = 7.14 \text{ hours}$ .

(e). Note that  $0.2 = 200/1000$ . Consider the differential equation

$$\frac{dq}{dt} = -\frac{r}{1000}q.$$

Here the parameter  $r$  corresponds to the flow rate, measured in gallons per minute. Using the same initial value, the solution is given by  $q(t) = 5000 e^{-rt/1000}$ . In order to determine the appropriate flow rate, set  $t = 4$  and  $q = 1200$ . (Recall that 1200 gm of

dye has a concentration of  $0.02 \text{ gm/gal}$ ). We obtain the equation  $1200 = 5000 e^{-r/250}$ . Taking the natural logarithm of both sides of the equation results in the required flow rate  $r = 357 \text{ gallons per minute}$ .

## Section 1.3

1. The differential equation is *second order*, since the highest derivative in the equation is of order *two*. The equation is *linear*, since the left hand side is a linear function of  $y$  and its derivatives.

3. The differential equation is *fourth order*, since the highest derivative of the function  $y$  is of order *four*. The equation is also *linear*, since the terms containing the dependent variable is linear in  $y$  and its derivatives.

4. The differential equation is *first order*, since the only derivative is of order *one*. The dependent variable is *squared*, hence the equation is *nonlinear*.

5. The differential equation is *second order*. Furthermore, the equation is *nonlinear*, since the dependent variable  $y$  is an argument of the *sine function*, which is *not* a linear function.

7.  $y_1(t) = e^t \Rightarrow y_1'(t) = y_1''(t) = e^t$ . Hence  $y_1'' - y_1 = 0$ .

Also,  $y_2(t) = \cosh t \Rightarrow y_2'(t) = \sinh t$  and  $y_2''(t) = \cosh t$ . Thus  $y_2'' - y_2 = 0$ .

9.  $y(t) = 3t + t^2 \Rightarrow y'(t) = 3 + 2t$ . Substituting into the differential equation, we have  $t(3 + 2t) - (3t + t^2) = 3t + 2t^2 - 3t - t^2 = t^2$ . Hence the given function is a solution.

10.  $y_1(t) = t/3 \Rightarrow y_1'(t) = 1/3$  and  $y_1''(t) = y_1'''(t) = y_1''''(t) = 0$ . Clearly,  $y_1(t)$  is a solution. Likewise,  $y_2(t) = e^{-t} + t/3 \Rightarrow y_2'(t) = -e^{-t} + 1/3$ ,  $y_2''(t) = e^{-t}$ ,  $y_2'''(t) = -e^{-t}$ ,  $y_2''''(t) = e^{-t}$ . Substituting into the left hand side of the equation, we find that  $e^{-t} + 4(-e^{-t}) + 3(e^{-t} + t/3) = e^{-t} - 4e^{-t} + 3e^{-t} + t = t$ . Hence both functions are solutions of the differential equation.

11.  $y_1(t) = t^{1/2} \Rightarrow y_1'(t) = t^{-1/2}/2$  and  $y_1''(t) = -t^{-3/2}/4$ . Substituting into the left hand side of the equation, we have

$$\begin{aligned} 2t^2(-t^{-3/2}/4) + 3t(t^{-1/2}/2) - t^{1/2} &= -t^{1/2}/2 + 3t^{1/2}/2 - t^{1/2} \\ &= 0 \end{aligned}$$

Likewise,  $y_2(t) = t^{-1} \Rightarrow y_2'(t) = -t^{-2}$  and  $y_2''(t) = 2t^{-3}$ . Substituting into the left hand side of the differential equation, we have  $2t^2(2t^{-3}) + 3t(-t^{-2}) - t^{-1} = 4t^{-1} - 3t^{-1} - t^{-1} = 0$ . Hence both functions are solutions of the differential equation.

12.  $y_1(t) = t^{-2} \Rightarrow y_1'(t) = -2t^{-3}$  and  $y_1''(t) = 6t^{-4}$ . Substituting into the left hand side of the differential equation, we have  $t^2(6t^{-4}) + 5t(-2t^{-3}) + 4t^{-2} = 6t^{-2} - 10t^{-2} + 4t^{-2} = 0$ . Likewise,  $y_2(t) = t^{-2} \ln t \Rightarrow y_2'(t) = t^{-3} - 2t^{-3} \ln t$  and  $y_2''(t) = -5t^{-4} + 6t^{-4} \ln t$ . Substituting into the left hand side of the equation, we have  $t^2(-5t^{-4} + 6t^{-4} \ln t) + 5t(t^{-3} - 2t^{-3} \ln t) + 4(t^{-2} \ln t) = -5t^{-2} + 6t^{-2} \ln t +$

$+ 5t^{-2} - 10t^{-2} \ln t + 4t^{-2} \ln t = 0$ . Hence both functions are solutions of the differential equation.

13.  $y(t) = (\cos t) \ln \cos t + t \sin t \Rightarrow y'(t) = -(\sin t) \ln \cos t + t \cos t$  and  $y''(t) = -(\cos t) \ln \cos t - t \sin t + \sec t$ . Substituting into the left hand side of the differential equation, we have  $(-(\cos t) \ln \cos t - t \sin t + \sec t) + (\cos t) \ln \cos t + t \sin t = -(\cos t) \ln \cos t - t \sin t + \sec t + (\cos t) \ln \cos t + t \sin t = \sec t$ . Hence the function  $y(t)$  is a solution of the differential equation.

15. Let  $y(t) = e^{rt}$ . Then  $y''(t) = r^2 e^{rt}$ , and substitution into the differential equation results in  $r^2 e^{rt} + 2e^{rt} = 0$ . Since  $e^{rt} \neq 0$ , we obtain the algebraic equation  $r^2 + 2 = 0$ . The roots of this equation are  $r_{1,2} = \pm i\sqrt{2}$ .

17.  $y(t) = e^{rt} \Rightarrow y'(t) = r e^{rt}$  and  $y''(t) = r^2 e^{rt}$ . Substituting into the differential equation, we have  $r^2 e^{rt} + r e^{rt} - 6 e^{rt} = 0$ . Since  $e^{rt} \neq 0$ , we obtain the algebraic equation  $r^2 + r - 6 = 0$ , that is,  $(r - 2)(r + 3) = 0$ . The roots are  $r_{1,2} = -3, 2$ .

18. Let  $y(t) = e^{rt}$ . Then  $y'(t) = r e^{rt}$ ,  $y''(t) = r^2 e^{rt}$  and  $y'''(t) = r^3 e^{rt}$ . Substituting the derivatives into the differential equation, we have  $r^3 e^{rt} - 3r^2 e^{rt} + 2r e^{rt} = 0$ . Since  $e^{rt} \neq 0$ , we obtain the algebraic equation  $r^3 - 3r^2 + 2r = 0$ . By inspection, it follows that  $r(r - 1)(r - 2) = 0$ . Clearly, the roots are  $r_1 = 0$ ,  $r_2 = 1$  and  $r_3 = 2$ .

20.  $y(t) = t^r \Rightarrow y'(t) = r t^{r-1}$  and  $y''(t) = r(r - 1)t^{r-2}$ . Substituting the derivatives into the differential equation, we have  $t^2[r(r - 1)t^{r-2}] - 4t(r t^{r-1}) + 4t^r = 0$ . After some algebra, it follows that  $r(r - 1)t^r - 4r t^r + 4t^r = 0$ . For  $t \neq 0$ , we obtain the algebraic equation  $r^2 - 5r + 4 = 0$ . The roots of this equation are  $r_1 = 1$  and  $r_2 = 4$ .

21. The order of the partial differential equation is *two*, since the highest derivative, in fact each one of the derivatives, is of *second order*. The equation is *linear*, since the left hand side is a linear function of the partial derivatives.

23. The partial differential equation is *fourth order*, since the highest derivative, and in fact each of the derivatives, is of order *four*. The equation is *linear*, since the left hand side is a linear function of the partial derivatives.

24. The partial differential equation is *second order*, since the highest derivative of the function  $u(x, y)$  is of order *two*. The equation is *nonlinear*, due to the product  $u \cdot u_x$  on the left hand side of the equation.

25.  $u_1(x, y) = \cos x \cosh y \Rightarrow \frac{\partial^2 u_1}{\partial x^2} = -\cos x \cosh y$  and  $\frac{\partial^2 u_1}{\partial y^2} = \cos x \cosh y$ .

It is evident that  $\frac{\partial^2 u_1}{\partial x^2} + \frac{\partial^2 u_1}{\partial y^2} = 0$ . Likewise, given  $u_2(x, y) = \ln(x^2 + y^2)$ , the second derivatives are



$$\frac{\partial^2 u_2}{\partial x^2} = \frac{2}{x^2 + y^2} - \frac{4x^2}{(x^2 + y^2)^2}$$

$$\frac{\partial^2 u_2}{\partial y^2} = \frac{2}{x^2 + y^2} - \frac{4y^2}{(x^2 + y^2)^2}$$

Adding the partial derivatives,

$$\begin{aligned} \frac{\partial^2 u_2}{\partial x^2} + \frac{\partial^2 u_2}{\partial y^2} &= \frac{2}{x^2 + y^2} - \frac{4x^2}{(x^2 + y^2)^2} + \frac{2}{x^2 + y^2} - \frac{4y^2}{(x^2 + y^2)^2} \\ &= \frac{4}{x^2 + y^2} - \frac{4(x^2 + y^2)}{(x^2 + y^2)^2} \\ &= 0. \end{aligned}$$

Hence  $u_2(x, y)$  is also a solution of the differential equation.

27. Let  $u_1(x, t) = \sin \lambda x \sin \lambda at$ . Then the second derivatives are

$$\frac{\partial^2 u_1}{\partial x^2} = -\lambda^2 \sin \lambda x \sin \lambda at$$

$$\frac{\partial^2 u_1}{\partial t^2} = -\lambda^2 a^2 \sin \lambda x \sin \lambda at$$

It is easy to see that  $a^2 \frac{\partial^2 u_1}{\partial x^2} = \frac{\partial^2 u_1}{\partial t^2}$ . Likewise, given  $u_2(x, t) = \sin(x - at)$ , we have

$$\frac{\partial^2 u_2}{\partial x^2} = -\sin(x - at)$$

$$\frac{\partial^2 u_2}{\partial t^2} = -a^2 \sin(x - at)$$

Clearly,  $u_2(x, t)$  is also a solution of the partial differential equation.

28. Given the function  $u(x, t) = \sqrt{\pi/t} e^{-x^2/4\alpha^2 t}$ , the partial derivatives are

$$u_{xx} = -\frac{\sqrt{\pi/t} e^{-x^2/4\alpha^2 t}}{2\alpha^2 t} + \frac{\sqrt{\pi/t} x^2 e^{-x^2/4\alpha^2 t}}{4\alpha^4 t^2}$$

$$u_t = -\frac{\sqrt{\pi t} e^{-x^2/4\alpha^2 t}}{2t^2} + \frac{\sqrt{\pi} x^2 e^{-x^2/4\alpha^2 t}}{4\alpha^2 t^2 \sqrt{t}}$$

It follows that  $\alpha^2 u_{xx} = u_t = -\frac{\sqrt{\pi} (2\alpha^2 t - x^2) e^{-x^2/4\alpha^2 t}}{4\alpha^2 t^2 \sqrt{t}}$ .

Hence  $u(x, t)$  is a solution of the partial differential equation.

29(a).

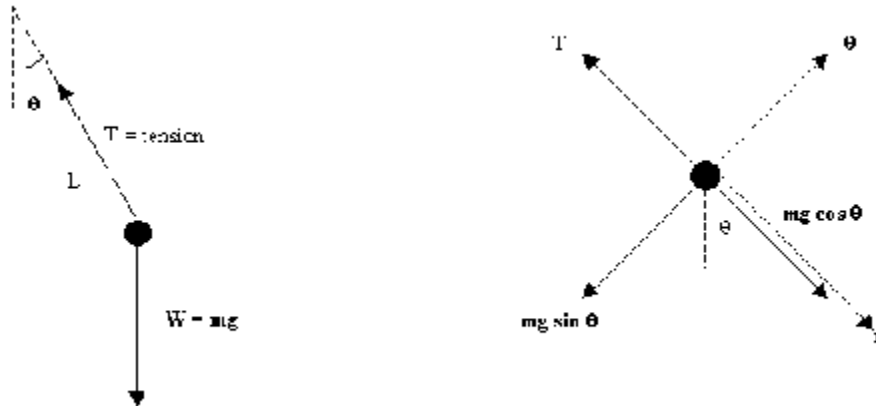

(b). The path of the particle is a circle, therefore *polar coordinates* are intrinsic to the problem. The variable  $r$  is radial distance and the angle  $\theta$  is measured from the vertical. Newton's Second Law states that  $\sum \mathbf{F} = m\mathbf{a}$ . In the *tangential* direction, the equation of motion may be expressed as  $\sum F_\theta = m a_\theta$ , in which the *tangential acceleration*, that is, the linear acceleration *along* the path is  $a_\theta = L d^2\theta/dt^2$ . ( $a_\theta$  is *positive* in the direction of increasing  $\theta$ ). Since the only force acting in the tangential direction is the component of weight, the equation of motion is

$$-mg \sin \theta = mL \frac{d^2\theta}{dt^2}.$$

(Note that the equation of motion in the radial direction will include the tension in the rod).

(c). Rearranging the terms results in the differential equation

$$\frac{d^2\theta}{dt^2} + \frac{g}{L} \sin \theta = 0.$$

## Chapter Two

### Section 2.1

1(a).

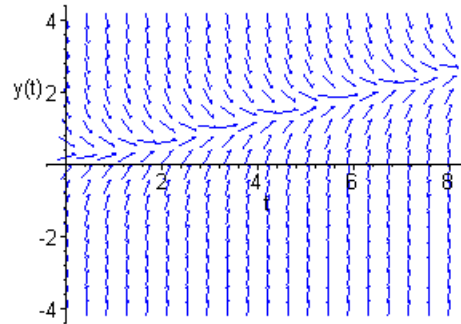

(b). Based on the direction field, all solutions seem to converge to a specific increasing function.

(c). The integrating factor is  $\mu(t) = e^{3t}$ , and hence  $y(t) = t/3 - 1/9 + e^{-2t} + c e^{-3t}$ . It follows that all solutions converge to the function  $y_1(t) = t/3 - 1/9$ .

2(a).

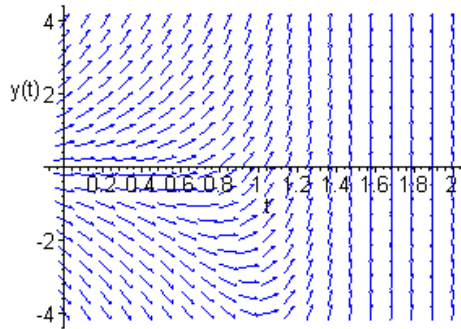

(b). All slopes *eventually* become positive, hence all solutions will increase without bound.

(c). The integrating factor is  $\mu(t) = e^{-2t}$ , and hence  $y(t) = t^3 e^{2t}/3 + c e^{2t}$ . It is evident that all solutions increase at an exponential rate.

3(a)

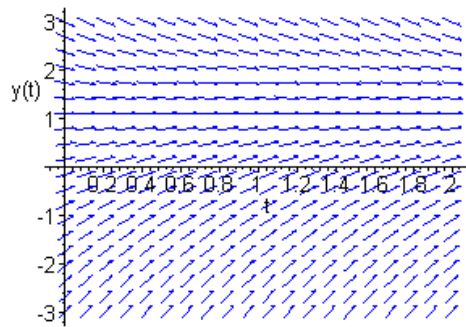

(b). All solutions seem to converge to the function  $y_0(t) = 1$ .

(c). The integrating factor is  $\mu(t) = e^{2t}$ , and hence  $y(t) = t^2 e^{-t}/2 + 1 + c e^{-t}$ . It is clear that all solutions converge to the specific solution  $y_0(t) = 1$ .

4(a).

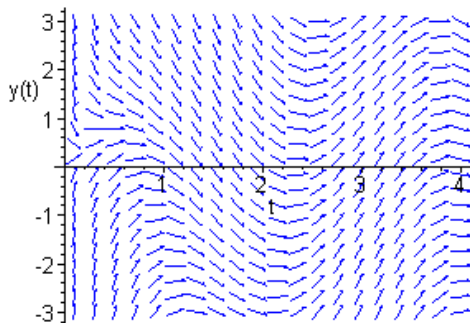

(b). Based on the direction field, the solutions eventually become oscillatory.

(c). The integrating factor is  $\mu(t) = t$ , and hence the general solution is

$$y(t) = \frac{3\cos(2t)}{4t} + \frac{3}{2}\sin(2t) + \frac{c}{t}$$

in which  $c$  is an arbitrary constant. As  $t$  becomes large, all solutions converge to the function  $y_1(t) = 3\sin(2t)/2$ .

5(a).

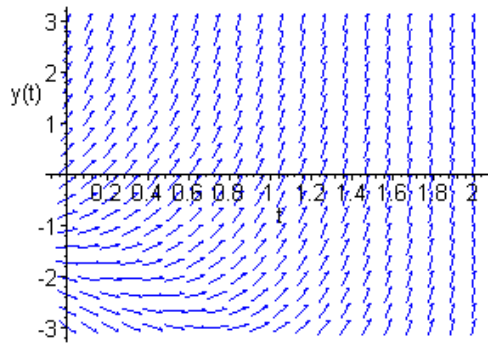

(b). All slopes *eventually* become positive, hence all solutions will increase without bound.

(c). The integrating factor is  $\mu(t) = \exp(-\int 2dt) = e^{-2t}$ . The differential equation can be written as  $e^{-2t}y' - 2e^{-2t}y = 3e^{-t}$ , that is,  $(e^{-2t}y)' = 3e^{-t}$ . Integration of both sides of the equation results in the general solution  $y(t) = -3e^t + ce^{2t}$ . It follows that all solutions will increase exponentially.

6(a)

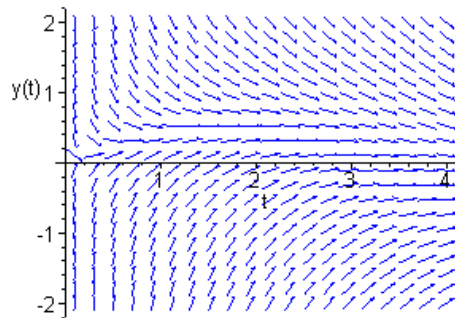

(b). All solutions seem to converge to the function  $y_0(t) = 0$ .

(c). The integrating factor is  $\mu(t) = t^2$ , and hence the general solution is

$$y(t) = -\frac{\cos(t)}{t} + \frac{\sin(2t)}{t^2} + \frac{c}{t^2}$$

in which  $c$  is an arbitrary constant. As  $t$  becomes large, all solutions converge to the function  $y_0(t) = 0$ .

7(a).

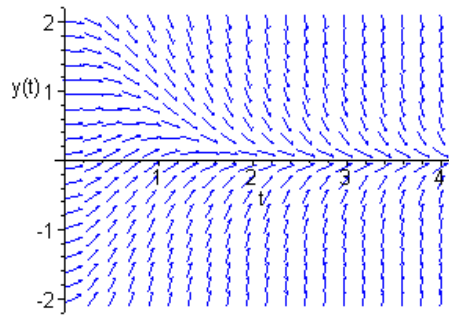

(b). All solutions seem to converge to the function  $y_0(t) = 0$ .

(c). The integrating factor is  $\mu(t) = \exp(t^2)$ , and hence  $y(t) = t^2 e^{-t^2} + c e^{-t^2}$ . It is clear that all solutions converge to the function  $y_0(t) = 0$ .

8(a)

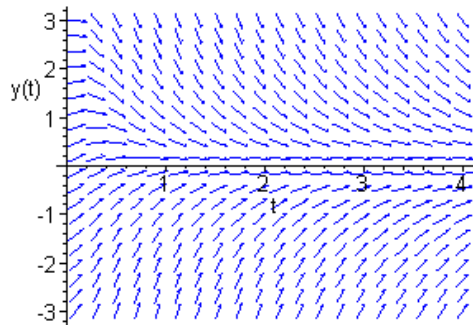

(b). All solutions seem to converge to the function  $y_0(t) = 0$ .

(c). Since  $\mu(t) = (1 + t^2)^2$ , the general solution is  $y(t) = [\tan^{-1}(t) + C]/(1 + t^2)^2$ . It follows that all solutions converge to the function  $y_0(t) = 0$ .

9(a).

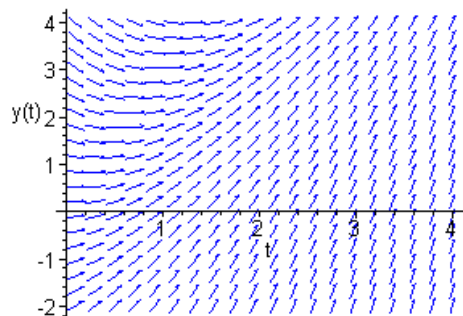

(b). All slopes *eventually* become positive, hence all solutions will increase without bound.

(c). The integrating factor is  $\mu(t) = \exp(\int \frac{1}{2} dt) = e^{t/2}$ . The differential equation can be written as  $e^{t/2}y' + e^{t/2}y/2 = 3t e^{t/2}/2$ , that is,  $(e^{t/2}y/2)' = 3t e^{t/2}/2$ . Integration of both sides of the equation results in the general solution  $y(t) = 3t - 6 + c e^{-t/2}$ . All solutions approach the specific solution  $y_0(t) = 3t - 6$ .

10(a).

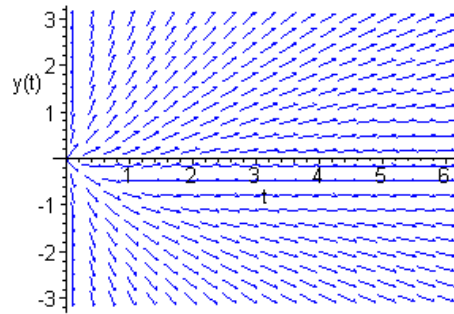

(b). For  $y > 0$ , the slopes are *all* positive, and hence the corresponding solutions increase without bound. For  $y < 0$ , almost all solutions have negative slopes, and hence solutions tend to decrease without bound.

(c). First divide both sides of the equation by  $t$ . From the resulting *standard form*, the integrating factor is  $\mu(t) = \exp(-\int \frac{1}{t} dt) = 1/t$ . The differential equation can be written as  $y'/t - y/t^2 = t e^{-t}$ , that is,  $(y/t)' = t e^{-t}$ . Integration leads to the general solution  $y(t) = -t e^{-t} + c t$ . For  $c \neq 0$ , solutions *diverge*, as implied by the direction field. For the case  $c = 0$ , the specific solution is  $y(t) = -t e^{-t}$ , which evidently approaches *zero* as  $t \rightarrow \infty$ .

11(a).

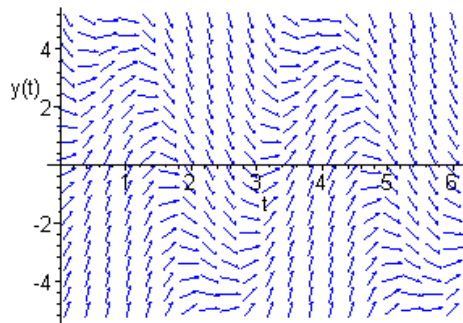

(b). The solutions appear to be oscillatory.

(c). The integrating factor is  $\mu(t) = e^t$ , and hence  $y(t) = \sin(2t) - 2 \cos(2t) + c e^{-t}$ . It is evident that all solutions converge to the specific solution  $y_0(t) = \sin(2t) - 2 \cos(2t)$ .

12(a).

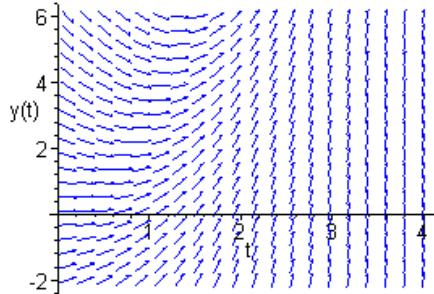

(b). All solutions *eventually* have positive slopes, and hence increase without bound.

(c). The integrating factor is  $\mu(t) = e^{2t}$ . The differential equation can be written as  $e^{t/2}y' + e^{t/2}y/2 = 3t^2/2$ , that is,  $(e^{t/2}y/2)' = 3t^2/2$ . Integration of both sides of the equation results in the general solution  $y(t) = 3t^2 - 12t + 24 + c e^{-t/2}$ . It follows that all solutions converge to the specific solution  $y_0(t) = 3t^2 - 12t + 24$ .

14. The integrating factor is  $\mu(t) = e^{2t}$ . After multiplying both sides by  $\mu(t)$ , the equation can be written as  $(e^{2t}y)' = t$ . Integrating both sides of the equation results in the general solution  $y(t) = t^2 e^{-2t}/2 + c e^{-2t}$ . Invoking the specified condition, we require that  $e^{-2}/2 + c e^{-2} = 0$ . Hence  $c = -1/2$ , and the solution to the initial value problem is  $y(t) = (t^2 - 1)e^{-2t}/2$ .

16. The integrating factor is  $\mu(t) = \exp(\int \frac{2}{t} dt) = t^2$ . Multiplying both sides by  $\mu(t)$ , the equation can be written as  $(t^2 y)' = \cos(t)$ . Integrating both sides of the equation results in the general solution  $y(t) = \sin(t)/t^2 + c t^{-2}$ . Substituting  $t = \pi$  and setting the value equal to *zero* gives  $c = 0$ . Hence the specific solution is  $y(t) = \sin(t)/t^2$ .

17. The integrating factor is  $\mu(t) = e^{-2t}$ , and the differential equation can be written as  $(e^{-2t}y)' = 1$ . Integrating, we obtain  $e^{-2t}y(t) = t + c$ . Invoking the specified initial condition results in the solution  $y(t) = (t + 2)e^{2t}$ .

19. After writing the equation in *standard form*, we find that the integrating factor is  $\mu(t) = \exp(\int \frac{4}{t} dt) = t^4$ . Multiplying both sides by  $\mu(t)$ , the equation can be written as  $(t^4 y)' = t e^{-t}$ . Integrating both sides results in  $t^4 y(t) = -(t + 1)e^{-t} + c$ . Letting  $t = -1$  and setting the value equal to *zero* gives  $c = 0$ . Hence the specific solution of the initial value problem is  $y(t) = -(t^{-3} + t^{-4})e^{-t}$ .

21(a).



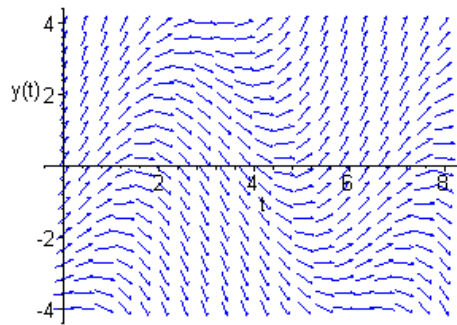

The solutions appear to diverge from an *apparent* oscillatory solution. From the direction field, the critical value of the initial condition seems to be  $a_0 = -1$ . For  $a > -1$ , the solutions increase without bound. For  $a < -1$ , solutions decrease without bound.

(b). The integrating factor is  $\mu(t) = e^{-t/2}$ . The general solution of the differential equation is  $y(t) = (8\sin(t) - 4\cos(t))/5 + c e^{t/2}$ . The solution is sinusoidal as long as  $c = 0$ . The *initial value* of this sinusoidal solution is  $a_0 = (8\sin(0) - 4\cos(0))/5 = -4/5$ .

(c). See part (b).

22(a).

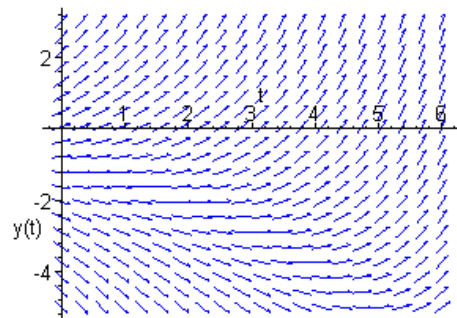

All solutions appear to *eventually* increase without bound. The solutions *initially* increase or decrease, depending on the initial value  $a$ . The critical value seems to be  $a_0 = -1$ .

(b). The integrating factor is  $\mu(t) = e^{-t/2}$ , and the general solution of the differential equation is  $y(t) = -3e^{t/3} + c e^{t/2}$ . Invoking the initial condition  $y(0) = a$ , the solution may also be expressed as  $y(t) = -3e^{t/3} + (a + 3) e^{t/2}$ . Differentiating, follows that  $y'(0) = -1 + (a + 3)/2 = (a + 1)/2$ . The critical value is evidently  $a_0 = -1$ .

(c). For  $a_0 = -1$ , the solution is  $y(t) = -3e^{t/3} + 2e^{t/2}$ , which (for large  $t$ ) is dominated by the term containing  $e^{t/2}$ .

is  $y(t) = (8\sin(t) - 4\cos(t))/5 + ce^{t/2}$ .

23(a).

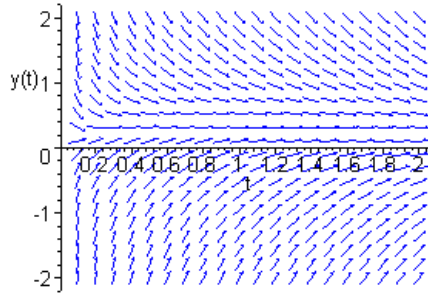

As  $t \rightarrow 0$ , solutions increase without bound if  $y(1) = a > .4$ , and solutions decrease without bound if  $y(1) = a < .4$ .

(b). The integrating factor is  $\mu(t) = \exp\left(\int \frac{t+1}{t} dt\right) = te^t$ . The general solution of the differential equation is  $y(t) = te^{-t} + ce^{-t}/t$ . Invoking the specified value  $y(1) = a$ , we have  $1 + c = ae$ . That is,  $c = ae - 1$ . Hence the solution can also be expressed as  $y(t) = te^{-t} + (ae - 1)e^{-t}/t$ . For *small* values of  $t$ , the second term is dominant. Setting  $ae - 1 = 0$ , critical value of the parameter is  $a_0 = 1/e$ .

(c). For  $a > 1/e$ , solutions increase without bound. For  $a < 1/e$ , solutions decrease without bound. When  $a = 1/e$ , the solution is  $y(t) = te^{-t}$ , which approaches 0 as  $t \rightarrow 0$ .

24(a).

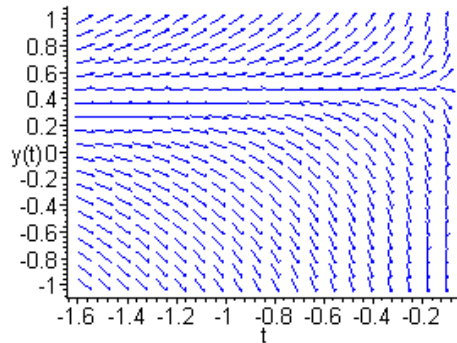

As  $t \rightarrow 0$ , solutions increase without bound if  $y(1) = a > .4$ , and solutions decrease without bound if  $y(1) = a < .4$ .

(b). Given the initial condition,  $y(-\pi/2) = a$ , the solution is  $y(t) = (a\pi^2/4 - \cos t)/t$ .

Since  $\lim_{t \rightarrow 0} \cos t = 1$ , solutions increase without bound if  $a > 4/\pi^2$ , and solutions decrease without bound if  $a < 4/\pi^2$ . Hence the critical value is  $a_0 = 4/\pi^2 = 0.452847\dots$

(c). For  $a = 4/\pi^2$ , the solution is  $y(t) = (1 - \cos t)/t$ , and  $\lim_{t \rightarrow 0} y(t) = 1/2$ . Hence the solution is bounded.

25. The integrating factor is  $\mu(t) = \exp(\int \frac{1}{2} dt) = e^{t/2}$ . Therefore general solution is  $y(t) = [4\cos(t) + 8\sin(t)]/5 + c e^{-t/2}$ . Invoking the initial condition, the specific solution is  $y(t) = [4\cos(t) + 8\sin(t) - 9 e^{t/2}]/5$ . Differentiating, it follows that

$$\begin{aligned} y'(t) &= [-4\sin(t) + 8\cos(t) + 4.5 e^{-t/2}]/5 \\ y''(t) &= [-4\cos(t) - 8\sin(t) - 2.25 e^{-t/2}]/5 \end{aligned}$$

Setting  $y'(t) = 0$ , the first solution is  $t_1 = 1.3643$ , which gives the location of the *first* stationary point. Since  $y''(t_1) < 0$ , the first stationary point is a local *maximum*. The coordinates of the point are  $(1.3643, .82008)$ .

26. The integrating factor is  $\mu(t) = \exp(\int \frac{2}{3} dt) = e^{2t/3}$ , and the differential equation can

be written as  $(e^{2t/3} y)' = e^{2t/3} - t e^{2t/3}/2$ . The general solution is  $y(t) = (21 - 6t)/8 + c e^{-2t/3}$ . Imposing the initial condition, we have  $y(t) = (21 - 6t)/8 + (y_0 - 21/8)e^{-2t/3}$ . Since the solution is smooth, the desired intersection will be a point of tangency. Taking the derivative,  $y'(t) = -3/4 - (2y_0 - 21/4)e^{-2t/3}/3$ . Setting  $y'(t) = 0$ , the solution is  $t_1 = \frac{3}{2} \ln[(21 - 8y_0)/9]$ . Substituting into the solution, the respective *value* at the stationary point is  $y(t_1) = \frac{3}{2} + \frac{9}{4} \ln 3 - \frac{9}{8} \ln(21 - 8y_0)$ . Setting this result equal to *zero*, we obtain the required initial value  $y_0 = (21 - 9 e^{4/3})/8 = -1.643$ .

27. The integrating factor is  $\mu(t) = e^{t/4}$ , and the differential equation can be written as  $(e^{t/4} y)' = 3 e^{t/4} + 2 e^{t/4} \cos(2t)$ . The general solution is

$$y(t) = 12 + [8\cos(2t) + 64\sin(2t)]/65 + c e^{-t/4}.$$

Invoking the initial condition,  $y(0) = 0$ , the specific solution is

$$y(t) = 12 + [8\cos(2t) + 64\sin(2t) - 788 e^{-t/4}]/65.$$

As  $t \rightarrow \infty$ , the exponential term will decay, and the solution will oscillate about an *average value* of 12, with an *amplitude* of  $8/\sqrt{65}$ .

29. The integrating factor is  $\mu(t) = e^{-3t/2}$ , and the differential equation can be written as  $(e^{-3t/2} y)' = 3t e^{-3t/2} + 2 e^{-t/2}$ . The general solution is  $y(t) = -2t - 4/3 - 4e^t + c e^{3t/2}$ . Imposing the initial condition,  $y(t) = -2t - 4/3 - 4e^t + (y_0 + 16/3) e^{3t/2}$ . As  $t \rightarrow \infty$ , the term containing  $e^{3t/2}$  will *dominate* the solution. Its *sign* will determine the divergence properties. Hence the critical value of the initial condition is

$$y_0 = -16/3.$$

The corresponding solution,  $y(t) = -2t - 4/3 - 4e^t$ , will also decrease without bound.

Note on Problems 31-34 :

Let  $g(t)$  be *given*, and consider the function  $y(t) = y_1(t) + g(t)$ , in which  $y_1(t) \rightarrow \infty$  as  $t \rightarrow \infty$ . Differentiating,  $y'(t) = y_1'(t) + g'(t)$ . Letting  $a$  be a *constant*, it follows that  $y'(t) + ay(t) = y_1'(t) + ay_1(t) + g'(t) + ag(t)$ . Note that the hypothesis on the function  $y_1(t)$  will be satisfied, if  $y_1'(t) + ay_1(t) = 0$ . That is,  $y_1(t) = c e^{-at}$ . Hence  $y(t) = c e^{-at} + g(t)$ , which is a solution of the equation  $y' + ay = g'(t) + ag(t)$ . For convenience, choose  $a = 1$ .

31. Here  $g(t) = 3$ , and we consider the linear equation  $y' + y = 3$ . The integrating factor is  $\mu(t) = e^t$ , and the differential equation can be written as  $(e^t y)' = 3e^t$ . The general solution is  $y(t) = 3 + c e^{-t}$ .

33.  $g(t) = 3 - t$ . Consider the linear equation  $y' + y = -1 + 3 - t$ . The integrating factor is  $\mu(t) = e^t$ , and the differential equation can be written as  $(e^t y)' = (2 - t)e^t$ . The general solution is  $y(t) = 3 - t + c e^{-t}$ .

34.  $g(t) = 4 - t^2$ . Consider the linear equation  $y' + y = 4 - 2t - t^2$ . The integrating factor is  $\mu(t) = e^t$ , and the equation can be written as  $(e^t y)' = (4 - 2t - t^2)e^t$ . The general solution is  $y(t) = 4 - t^2 + c e^{-t}$ .

**Section 2.2**

2. For  $x \neq -1$ , the differential equation may be written as  $y dy = [x^2/(1+x^3)]dx$ . Integrating both sides, with respect to the appropriate variables, we obtain the relation

$$y^2/2 = \frac{1}{3} \ln|1+x^3| + c. \text{ That is, } y(x) = \pm \sqrt{\frac{2}{3} \ln|1+x^3| + c}.$$

3. The differential equation may be written as  $y^{-2}dy = -\sin x dx$ . Integrating both sides of the equation, with respect to the appropriate variables, we obtain the relation  $-y^{-1} = \cos x + c$ . That is,  $(C - \cos x)y = 1$ , in which  $C$  is an arbitrary constant. Solving for the dependent variable, explicitly,  $y(x) = 1/(C - \cos x)$ .

5. Write the differential equation as  $\cos^{-2} 2y dy = \cos^2 x dx$ , or  $\sec^2 2y dy = \cos^2 x dx$ . Integrating both sides of the equation, with respect to the appropriate variables, we obtain the relation  $\tan 2y = \sin x \cos x + x + c$ .

7. The differential equation may be written as  $(y + e^y)dy = (x - e^{-x})dx$ . Integrating both sides of the equation, with respect to the appropriate variables, we obtain the relation  $y^2 + 2e^y = x^2 + 2e^{-x} + c$ .

8. Write the differential equation as  $(1+y^2)dy = x^2 dx$ . Integrating both sides of the equation, we obtain the relation  $y + y^3/3 = x^3/3 + c$ , that is,  $3y + y^3 = x^3 + C$ .

9(a). The differential equation is separable, with  $y^{-2}dy = (1 - 2x)dx$ . Integration yields  $-y^{-1} = x - x^2 + c$ . Substituting  $x = 0$  and  $y = -1/6$ , we find that  $c = 6$ . Hence the specific solution is  $y^{-1} = x^2 - x - 6$ . The *explicit form* is  $y(x) = 1/(x^2 - x - 6)$ .

(b)

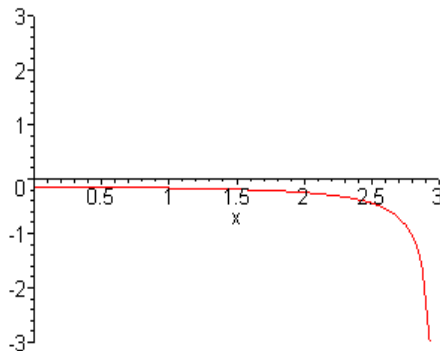

(c). Note that  $x^2 - x - 6 = (x + 2)(x - 3)$ . Hence the solution becomes *singular* at  $x = -2$  and  $x = 3$ .

10(a).  $y(x) = -\sqrt{2x - 2x^2 + 4}$ .

10(b).

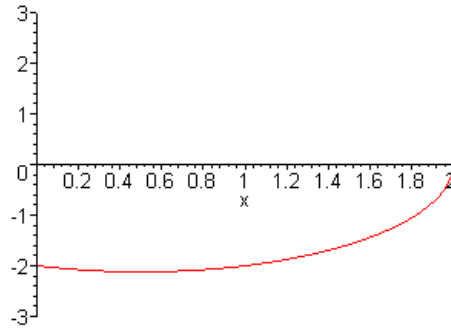

11(a). Rewrite the differential equation as  $x e^x dx = -y dy$ . Integrating both sides of the equation results in  $x e^x - e^x = -y^2/2 + c$ . Invoking the initial condition, we obtain  $c = -1/2$ . Hence  $y^2 = 2e^x - 2x e^x - 1$ . The *explicit form* of the solution is  $y(x) = \sqrt{2e^x - 2x e^x - 1}$ . The *positive sign* is chosen, since  $y(0) = 1$ .

(b).

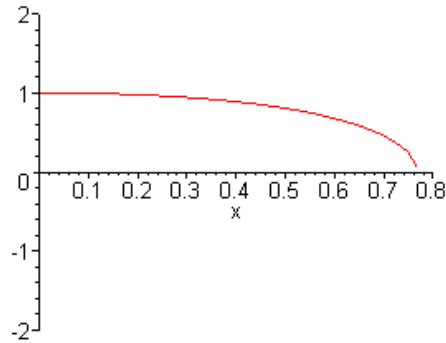

(c). The function under the radical becomes *negative* near  $x = -1.7$  and  $x = 0.76$ .

11(a). Write the differential equation as  $r^{-2} dr = \theta^{-1} d\theta$ . Integrating both sides of the equation results in the relation  $-r^{-1} = \ln \theta + c$ . Imposing the condition  $r(1) = 2$ , we obtain  $c = -1/2$ . The *explicit form* of the solution is  $r(\theta) = 2/(1 - 2 \ln \theta)$ .

(b).

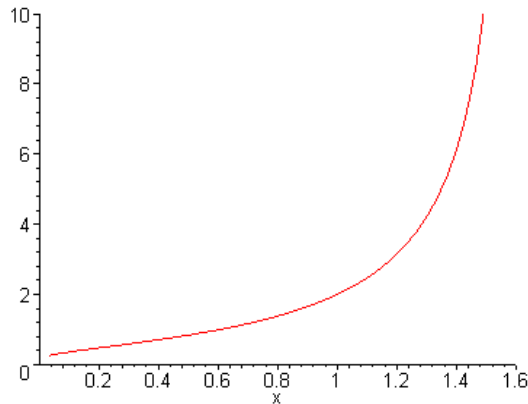

(c). Clearly, the solution makes sense only if  $\theta > 0$ . Furthermore, the solution becomes singular when  $\ln \theta = 1/2$ , that is,  $\theta = \sqrt{e}$ .

13(a).  $y(x) = -\sqrt{2\ln(1+x^2)+4}$ .

(b).

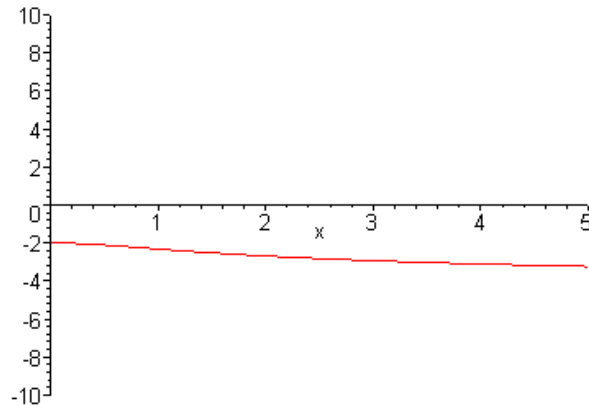

14(a). Write the differential equation as  $y^{-3}dy = x(1+x^2)^{-1/2} dx$ . Integrating both sides of the equation, with respect to the appropriate variables, we obtain the relation  $-y^{-2}/2 = \sqrt{1+x^2} + c$ . Imposing the initial condition, we obtain  $c = -3/2$ . Hence the specific solution can be expressed as  $y^{-2} = 3 - 2\sqrt{1+x^2}$ . The *explicit form* of the solution is  $y(x) = 1/\sqrt{3 - 2\sqrt{1+x^2}}$ . The *positive* sign is chosen to satisfy the initial condition.

(b).

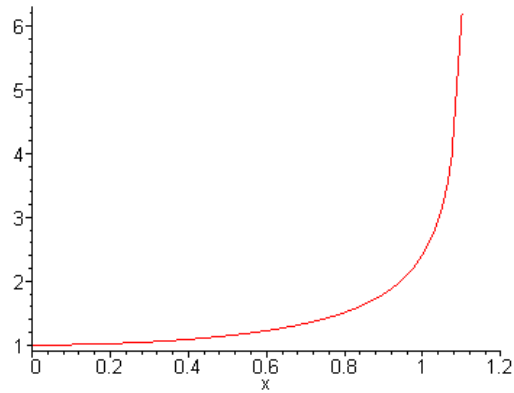

(c). The solution becomes singular when  $2\sqrt{1+x^2} = 3$ . That is, at  $x = \pm\sqrt{5}/2$ .

15(a).  $y(x) = -1/2 + \sqrt{x^2 - 15/4}$ .

(b).

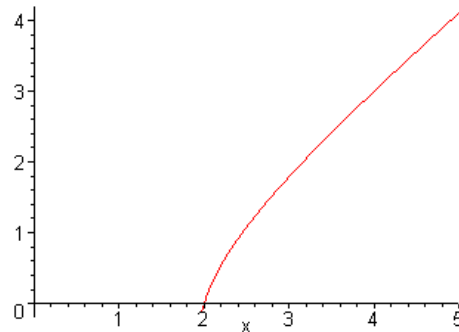

16(a). Rewrite the differential equation as  $4y^3 dy = x(x^2 + 1)dx$ . Integrating both sides of the equation results in  $y^4 = (x^2 + 1)^2/4 + c$ . Imposing the initial condition, we obtain  $c = 0$ . Hence the solution may be expressed as  $(x^2 + 1)^2 - 4y^4 = 0$ . The *explicit* form of the solution is  $y(x) = -\sqrt{(x^2 + 1)/2}$ . The *sign* is chosen based on  $y(0) = -1/\sqrt{2}$ .



(b).

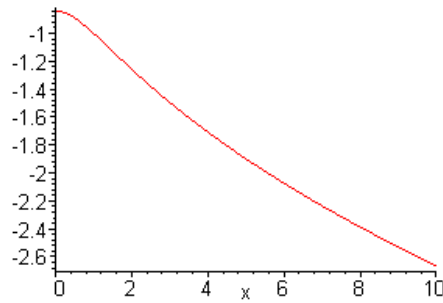

(c). The solution is valid for all  $x \in \mathbb{R}$ .

17(a).  $y(x) = -5/2 - \sqrt{x^3 - e^x + 13/4}$ .

(b).

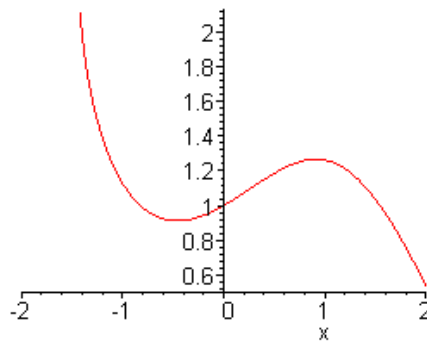

(c). The solution is valid for  $x > -1.45$ . This value is found by estimating the root of  $4x^3 - 4e^x + 13 = 0$ .

18(a). Write the differential equation as  $(3 + 4y)dy = (e^{-x} - e^x)dx$ . Integrating both sides of the equation, with respect to the appropriate variables, we obtain the relation  $3y + 2y^2 = -(e^x + e^{-x}) + c$ . Imposing the initial condition,  $y(0) = 1$ , we obtain  $c = 7$ . Thus, the solution can be expressed as  $3y + 2y^2 = -(e^x + e^{-x}) + 7$ . Now by *completing the square* on the left hand side,  $2(y + 3/4)^2 = -(e^x + e^{-x}) + 65/8$ . Hence the *explicit* form of the solution is  $y(x) = -3/4 + \sqrt{65/16 - \cosh x}$ .

(b).

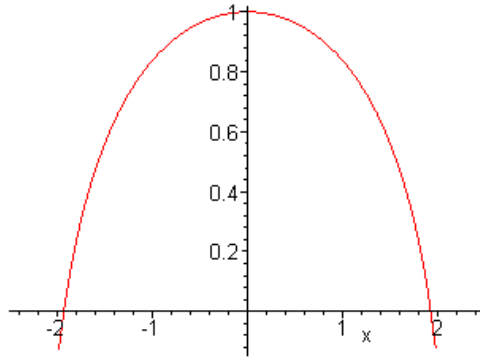

(c). Note the  $65 - 16 \cosh x \geq 0$ , as long as  $|x| > 2.1$ . Hence the solution is valid on the interval  $-2.1 < x < 2.1$ .

19(a).  $y(x) = -\pi/3 + \frac{1}{3} \sin^{-1}(3 \cos^2 x)$ .

(b).

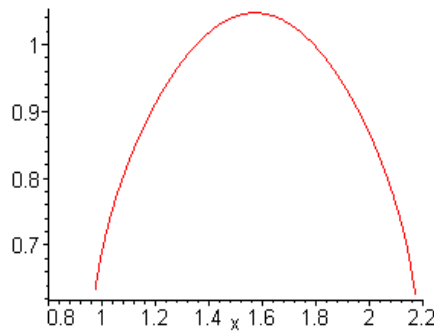

20(a). Rewrite the differential equation as  $y^2 dy = \arcsin x / \sqrt{1 - x^2} dx$ . Integrating both sides of the equation results in  $y^3/3 = (\arcsin x)^2/2 + c$ . Imposing the condition  $y(0) = 0$ , we obtain  $c = 0$ . The *explicit* form of the solution is  $y(x) = \sqrt[3]{\frac{3}{2} (\arcsin x)^2}$ .

(b).

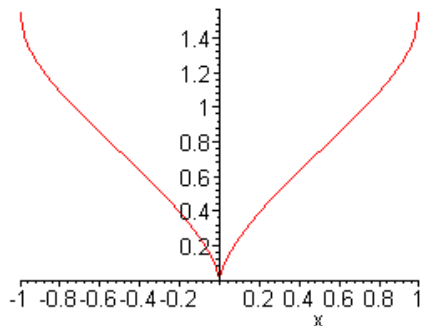

(c). Evidently, the solution is defined for  $-1 \leq x \leq 1$ .

22. The differential equation can be written as  $(3y^2 - 4)dy = 3x^2dx$ . Integrating both sides, we obtain  $y^3 - 4y = x^3 + c$ . Imposing the initial condition, the specific solution is  $y^3 - 4y = x^3 - 1$ . Referring back to the differential equation, we find that  $y' \rightarrow \infty$  as  $y \rightarrow \pm 2/\sqrt{3}$ . The respective values of the abscissas are  $x = -1.276, 1.598$ .

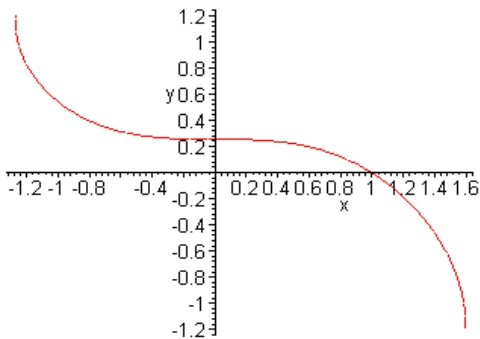

Hence the solution is valid for  $-1.276 < x < 1.598$ .

24. Write the differential equation as  $(3 + 2y)dy = (2 - e^x)dx$ . Integrating both sides, we obtain  $3y + y^2 = 2x - e^x + c$ . Based on the specified initial condition, the solution can be written as  $3y + y^2 = 2x - e^x + 1$ . *Completing the square*, it follows that  $y(x) = -3/2 + \sqrt{2x - e^x + 13/4}$ . The solution is defined if  $2x - e^x + 13/4 \geq 0$ , that is,  $-1.5 \leq x \leq 2$  (*approximately*). In that interval,  $y' = 0$ , for  $x = \ln 2$ . It can be verified that  $y''(\ln 2) < 0$ . In fact,  $y''(x) < 0$  on the interval of definition. Hence the solution attains a global maximum at  $x = \ln 2$ .

26. The differential equation can be written as  $(1 + y^2)^{-1}dy = 2(1 + x)dx$ . Integrating both sides of the equation, we obtain  $\arctan y = 2x + x^2 + c$ . Imposing the given initial condition, the specific solution is  $\arctan y = 2x + x^2$ . Therefore,  $y(x) = \tan(2x + x^2)$ . Observe that the solution is defined as long as  $-\pi/2 < 2x + x^2 < \pi/2$ . It is easy to see that  $2x + x^2 \geq -1$ . Furthermore,  $2x + x^2 = \pi/2$  for  $x = -2.6$  and  $0.6$ . Hence the solution is valid on the interval  $-2.6 < x < 0.6$ . Referring back to the differential

equation, the solution is *stationary* at  $x = -1$ . Since  $y''(x) > 0$  on the entire interval of definition, the solution attains a global minimum at  $x = -1$ .

28(a). Write the differential equation as  $y^{-1}(4 - y)^{-1}dy = t(1 + t)^{-1}dt$ . Integrating both sides of the equation, we obtain  $\ln|y| - \ln|y - 4| = 4t - 4\ln|1 + t| + c$ . Taking the *exponential* of both sides, it follows that  $|y/(y - 4)| = C e^{4t}/(1 + t)^4$ . It follows that as  $t \rightarrow \infty$ ,  $|y/(y - 4)| = |1 + 4/(y - 4)| \rightarrow \infty$ . That is,  $y(t) \rightarrow 4$ .

(b). Setting  $y(0) = 2$ , we obtain that  $C = 1$ . Based on the initial condition, the solution may be expressed as  $y/(y - 4) = -e^{4t}/(1 + t)^4$ . Note that  $y/(y - 4) < 0$ , for all  $t \geq 0$ . Hence  $y < 4$  for all  $t \geq 0$ . Referring back to the differential equation, it follows that  $y'$  is always *positive*. This means that the solution is *monotone increasing*. We find that the root of the equation  $e^{4t}/(1 + t)^4 = 399$  is near  $t = 2.844$ .

(c). Note the  $y(t) = 4$  is an equilibrium solution. Examining the local direction field,

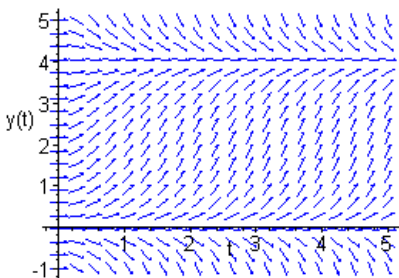

we see that if  $y(0) > 0$ , then the corresponding solutions converge to  $y = 4$ . Referring back to part (a), we have  $y/(y - 4) = [y_0/(y_0 - 4)]e^{4t}/(1 + t)^4$ , for  $y_0 \neq 4$ . Setting  $t = 2$ , we obtain  $y_0/(y_0 - 4) = (3/e^2)^4 y(2)/(y(2) - 4)$ . Now since the function  $f(y) = y/(y - 4)$  is *monotone* for  $y < 4$  and  $y > 4$ , we need only solve the equations  $y_0/(y_0 - 4) = -399(3/e^2)^4$  and  $y_0/(y_0 - 4) = 401(3/e^2)^4$ . The respective solutions are  $y_0 = 3.6622$  and  $y_0 = 4.4042$ .

30(f).

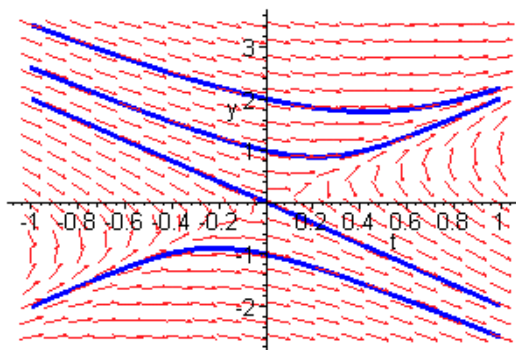

31(c)

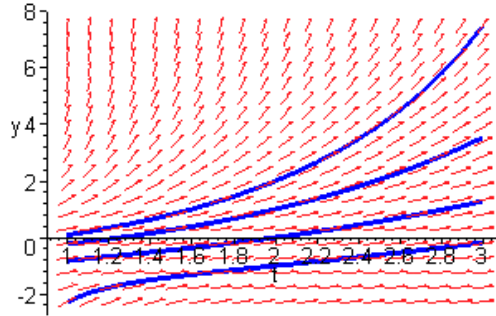

32(a). Observe that  $(x^2 + 3y^2)/2xy = \frac{1}{2}\left(\frac{y}{x}\right)^{-1} + \frac{3}{2}\frac{y}{x}$ . Hence the differential equation is *homogeneous*.

(b). The substitution  $y = xv$  results in  $v + xv' = (x^2 + 3x^2v^2)/2x^2v$ . The transformed equation is  $v' = (1 + v^2)/2xv$ . This equation is *separable*, with general solution  $v^2 + 1 = cx$ . In terms of the original dependent variable, the solution is  $x^2 + y^2 = cx^3$ .

(c).

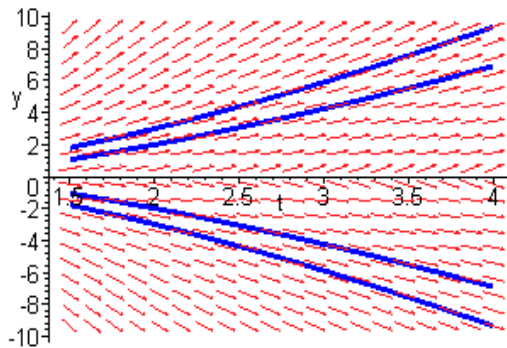

33(c).

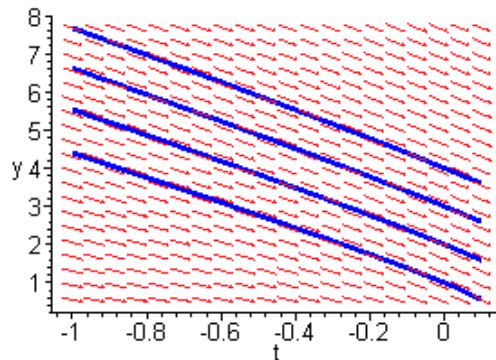

34(a). Observe that  $-(4x + 3y)/(2x + y) = -2 - \frac{y}{x} \left[2 + \frac{y}{x}\right]^{-1}$ . Hence the differential equation is *homogeneous*.

(b). The substitution  $y = xv$  results in  $v + xv' = -2 - v/(2 + v)$ . The transformed equation is  $v' = -(v^2 + 5v + 4)/(2 + v)x$ . This equation is *separable*, with general solution  $(v+4)^2|v+1| = C/x^3$ . In terms of the original dependent variable, the solution is  $(4x + y)^2|x+y| = C$ .

(c).

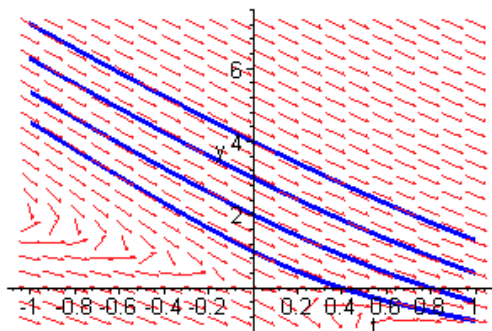

35(c).

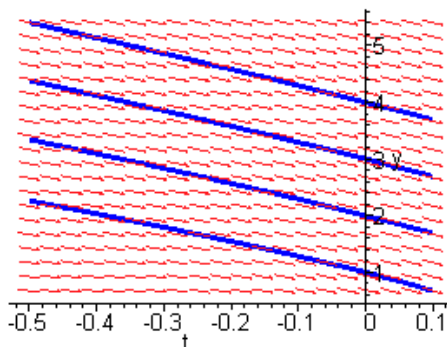

36(a). Divide by  $x^2$  to see that the equation is homogeneous. Substituting  $y = xv$ , we obtain  $xv' = (1 + v)^2$ . The resulting differential equation is separable.

(b). Write the equation as  $(1 + v)^{-2}dv = x^{-1}dx$ . Integrating both sides of the equation, we obtain the general solution  $-1/(1 + v) = \ln|x| + c$ . In terms of the original dependent variable, the solution is  $y = x [C - \ln|x|]^{-1} - x$ .

(c).

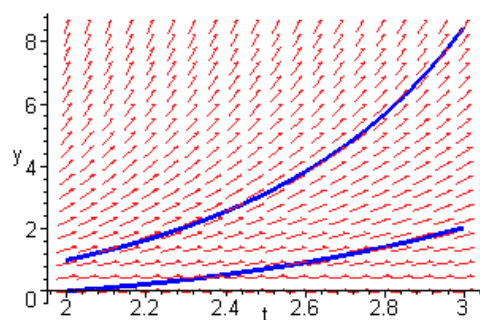

37(a). The differential equation can be expressed as  $y' = \frac{1}{2} \left(\frac{y}{x}\right)^{-1} - \frac{3}{2} \frac{y}{x}$ . Hence the equation is homogeneous. The substitution  $y = xv$  results in  $xv' = (1 - 5v^2)/2v$ . Separating variables, we have  $\frac{2v}{1-5v^2} dv = \frac{1}{x} dx$ .

(b). Integrating both sides of the transformed equation yields  $-\frac{1}{5}$

$$\ln|1 - 5v^2| = \ln|x| + c,$$

that is,  $1 - 5v^2 = C/|x|^5$ . In terms of the original dependent variable, the general solution is  $5y^2 = x^2 - C/|x|^3$ .

(c).

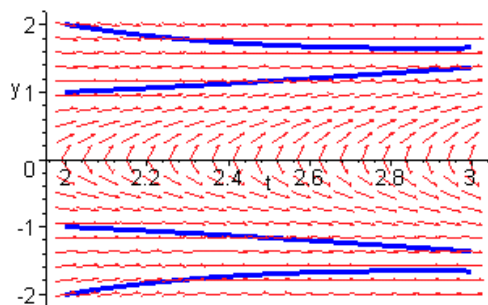

38(a). The differential equation can be expressed as  $y' = \frac{3}{2} \frac{y}{x} - \frac{1}{2} \left(\frac{y}{x}\right)^{-1}$ . Hence the equation is homogeneous. The substitution  $y = xv$  results in  $xv' = (v^2 - 1)/2v$ , that is,  $\frac{2v}{v^2-1} dv = \frac{1}{x} dx$ .

(b). Integrating both sides of the transformed equation yields  $\ln|v^2 - 1| = \ln|x| + c$ , that is,  $v^2 - 1 = C|x|$ . In terms of the original dependent variable, the general solution is  $y^2 = Cx^2|x| + x^2$ .

(c).

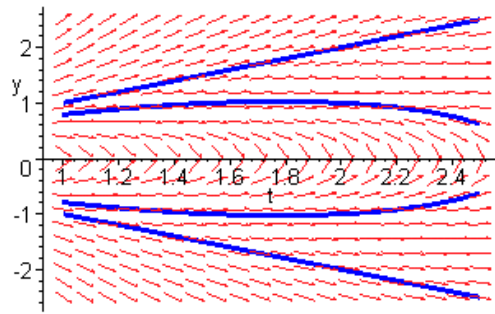



**Section 2.3**

5(a). Let  $Q$  be the amount of salt in the tank. Salt enters the tank of water at a rate of  $2\frac{1}{4}(1 + \frac{1}{2}\sin t) = \frac{1}{2} + \frac{1}{4}\sin t$  oz/min. It leaves the tank at a rate of  $2Q/100$  oz/min. Hence the differential equation governing the amount of salt at any time is

$$\frac{dQ}{dt} = \frac{1}{2} + \frac{1}{4}\sin t - Q/50.$$

The initial amount of salt is  $Q_0 = 50$  oz. The governing ODE is *linear*, with integrating factor  $\mu(t) = e^{t/50}$ . Write the equation as  $(e^{t/50}Q)' = e^{t/50}(\frac{1}{2} + \frac{1}{4}\sin t)$ . The specific solution is  $Q(t) = 25 + [12.5\sin t - 625\cos t + 63150 e^{-t/50}]/2501$  oz.

(b).

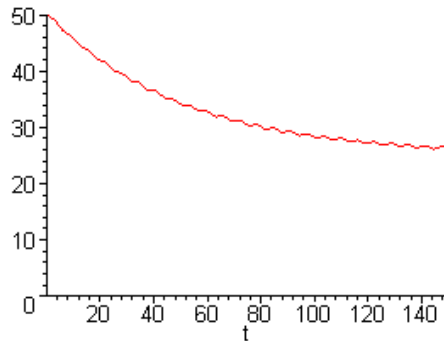

(c). The amount of salt approaches a *steady state*, which is an oscillation of amplitude  $1/4$  about a level of  $25$  oz.

6(a). The equation governing the value of the investment is  $dS/dt = rS$ . The value of the investment, at any time, is given by  $S(t) = S_0e^{rt}$ . Setting  $S(T) = 2S_0$ , the required time is  $T = \ln(2)/r$ .

(b). For the case  $r = 7\% = .07$ ,  $T \approx 9.9$  yrs.

(c). Referring to Part(a),  $r = \ln(2)/T$ . Setting  $T = 8$ , the required interest rate is to be approximately  $r = 8.66\%$ .

8(a). Based on the solution in Eq.(16), with  $S_0 = 0$ , the value of the investments *with* contributions is given by  $S(t) = 25,000(e^{rt} - 1)$ . After *ten* years, person A has  $S_A = \$25,000(1.226) = \$30,640$ . Beginning at age 35, the investments can now be analyzed using the equations  $S_A = 30,640 e^{.08t}$  and  $S_B = 25,000(e^{.08t} - 1)$ . After *thirty* years, the balances are  $S_A = \$337,734$  and  $S_B = \$250,579$ .

(b). For an *unspecified* rate  $r$ , the balances after *thirty* years are  $S_A = 30,640 e^{30r}$  and  $S_B = 25,000(e^{30r} - 1)$ .

(c).

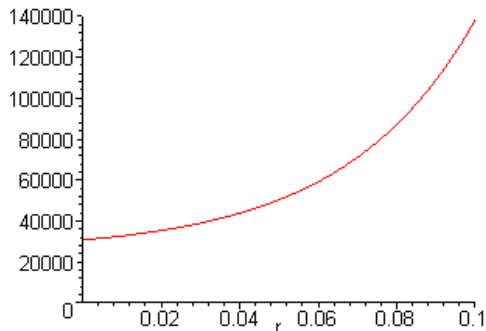

(d). The two balances can *never* be equal.

11(a). Let  $S$  be the value of the mortgage. The debt accumulates at a rate of  $rS$ , in which  $r = .09$  is the *annual* interest rate. Monthly payments of \$ 800 are equivalent to \$ 9,600 *per year*. The differential equation governing the value of the mortgage is  $dS/dt = .09S - 9,600$ . Given that  $S_0$  is the original amount borrowed, the debt is  $S(t) = S_0e^{.09t} - 106,667(e^{.09t} - 1)$ . Setting  $S(30) = 0$ , it follows that  $S_0 = \$99,500$ .

(b). The *total* payment, over 30 years, becomes \$ 288,000. The interest paid on this purchase is \$ 188,500.

13(a). The balance *increases* at a rate of  $rS$  \$/yr, and *decreases* at a constant rate of  $k$  \$ *per year*. Hence the balance is modeled by the differential equation  $dS/dt = rS - k$ . The balance at any time is given by  $S(t) = S_0e^{rt} - \frac{k}{r}(e^{rt} - 1)$ .

(b). The solution may also be expressed as  $S(t) = (S_0 - \frac{k}{r})e^{rt} + \frac{k}{r}$ . Note that if the withdrawal rate is  $k_0 = rS_0$ , the balance will remain at a constant level  $S_0$ .

(c). Assuming that  $k > k_0$ ,  $S(T_0) = 0$  for  $T_0 = \frac{1}{r} \ln \left[ \frac{k}{k - k_0} \right]$ .

(d). If  $r = .08$  and  $k = 2k_0$ , then  $T_0 = 8.66$  *years*.

(e). Setting  $S(t) = 0$  and solving for  $e^{rt}$  in Part(b),  $e^{rt} = \frac{k}{k - rS_0}$ . Now setting  $t = T$  results in  $k = rS_0e^{rT} / (e^{rT} - 1)$ .

(f). In part(e), let  $k = 12,000$ ,  $r = .08$ , and  $T = 20$ . The required investment becomes  $S_0 = \$119,715$ .

14(a). Let  $Q' = -rQ$ . The general solution is  $Q(t) = Q_0e^{-rt}$ . Based on the definition of *half-life*, consider the equation  $Q_0/2 = Q_0e^{-5730r}$ . It follows that

$-5730r = \ln(1/2)$ , that is,  $r = 1.2097 \times 10^{-4}$  per year.

(b). Hence the amount of carbon-14 is given by  $Q(t) = Q_0 e^{-1.2097 \times 10^{-4}t}$ .

(c). Given that  $Q(T) = Q_0/5$ , we have the equation  $1/5 = e^{-1.2097 \times 10^{-4}T}$ . Solving for the *decay time*, the apparent age of the remains is approximately  $T = 13,304.65$  years.

15. Let  $P(t)$  be the population of mosquitoes at any time  $t$ . The rate of *increase* of the mosquito population is  $rP$ . The population *decreases* by 20,000 per day. Hence the equation that models the population is given by  $dP/dt = rP - 20,000$ . Note that the variable  $t$  represents *days*. The solution is  $P(t) = P_0 e^{rt} - \frac{20,000}{r}(e^{rt} - 1)$ . In the absence of predators, the governing equation is  $dP_1/dt = rP_1$ , with solution  $P_1(t) = P_0 e^{rt}$ . Based on the data, set  $P_1(7) = 2P_0$ , that is,  $2P_0 = P_0 e^{7r}$ . The growth rate is determined as  $r = \ln(2)/7 = .09902$  per day. Therefore the population, including the *predation* by birds, is  $P(t) = 2 \times 10^5 e^{.099t} - 201,997(e^{.099t} - 1) = 201,997.3 - 1977.3 e^{.099t}$ .

16(a).  $y(t) = \exp[2/10 + t/10 - 2\cos(t)/10]$ . The *doubling-time* is  $\tau \approx 2.9632$ .

(b). The differential equation is  $dy/dt = y/10$ , with solution  $y(t) = y(0)e^{t/10}$ . The *doubling-time* is given by  $\tau = 10\ln(2) \approx 6.9315$ .

(c). Consider the differential equation  $dy/dt = (0.5 + \sin(2\pi t))y/5$ . The equation is *separable*, with  $\frac{1}{y}dy = (0.1 + \frac{1}{5}\sin(2\pi t))dt$ . Integrating both sides, with respect to the appropriate variable, we obtain  $\ln y = (\pi t - \cos(2\pi t))/10\pi + c$ . Invoking the initial condition, the solution is  $y(t) = \exp[(1 + \pi t - \cos(2\pi t))/10\pi]$ . The *doubling-time* is  $\tau \approx 6.3804$ . The *doubling-time* approaches the value found in part(b).

(d).

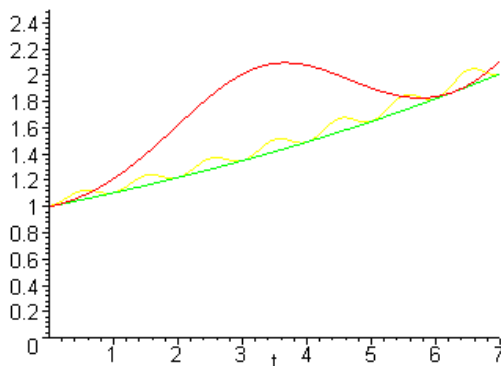

17(a). The differential equation  $dy/dt = r(t)y - k$  is *linear*, with integrating factor  $\mu(t) = \exp[-\int r(t)dt]$ . Write the equation as  $(\mu y)' = -k\mu(t)$ . Integration of both

sides yields the general solution  $y = [-k \int \mu(\tau) d\tau + y_0 \mu(0)] / \mu(t)$ . In this problem, the integrating factor is  $\mu(t) = \exp[(\cos t - t)/5]$ .

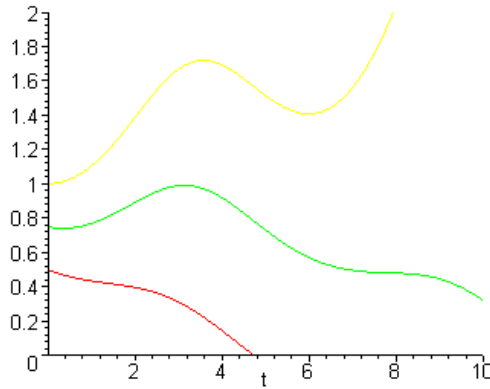

(b). The population becomes *extinct*, if  $y(t^*) = 0$ , for some  $t = t^*$ . Referring to part(a), we find that  $y(t^*) = 0 \Rightarrow$

$$\int_0^{t^*} \exp[(\cos \tau - \tau)/5] d\tau = 5 e^{1/5} y_c.$$

It can be shown that the integral on the left hand side increases *monotonically*, from zero to a limiting value of approximately 5.0893. Hence extinction can happen *only if*  $5 e^{1/5} y_c < 5.0893$ , that is,  $y_c < 0.8333$ .

(c). Repeating the argument in part(b), it follows that  $y(t^*) = 0 \Rightarrow$

$$\int_0^{t^*} \exp[(\cos \tau - \tau)/5] d\tau = \frac{1}{k} e^{1/5} y_c.$$

Hence extinction can happen *only if*  $e^{1/5} y_c / k < 5.0893$ , that is,  $y_c < 4.1667 k$ .

(d). Evidently,  $y_c$  is a *linear* function of the parameter  $k$ .

19(a). Let  $Q(t)$  be the *volume* of carbon monoxide in the room. The rate of *increase* of CO is  $(.04)(0.1) = 0.004 \text{ ft}^3/\text{min}$ . The amount of CO *leaves the room* at a rate of  $(0.1)Q(t)/1200 = Q(t)/12000 \text{ ft}^3/\text{min}$ . Hence the total rate of change is given by the differential equation  $dQ/dt = 0.004 - Q(t)/12000$ . This equation is *linear* and separable, with solution  $Q(t) = 48 - 48 \exp(-t/12000) \text{ ft}^3$ . Note that  $Q_0 = 0 \text{ ft}^3$ . Hence the *concentration* at any time is given by  $x(t) = Q(t)/1200 = Q(t)/12 \%$ .

(b). The *concentration* of CO in the room is  $x(t) = 4 - 4 \exp(-t/12000) \%$ . A level of 0.00012 corresponds to 0.012%. Setting  $x(\tau) = 0.012$ , the solution of the equation  $4 - 4 \exp(-t/12000) = 0.012$  is  $\tau \approx 36 \text{ minutes}$ .

20(a). The concentration is  $c(t) = k + P/r + (c_0 - k - P/r)e^{-rt/V}$ . It is easy to see that  $c(t \rightarrow \infty) = k + P/r$ .

(b).  $c(t) = c_0 e^{-rt/V}$ . The reduction times are  $T_{50} = \ln(2)V/r$  and  $T_{10} = \ln(10)V/r$ .

(c). The reduction times, in years, are  $T_S = \ln(10)(65.2)/12,200 = 430.85$   
 $T_M = \ln(10)(158)/4,900 = 71.4$ ;  $T_E = \ln(10)(175)/460 = 6.05$   
 $T_O = \ln(10)(209)/16,000 = 17.63$ .

21(c).

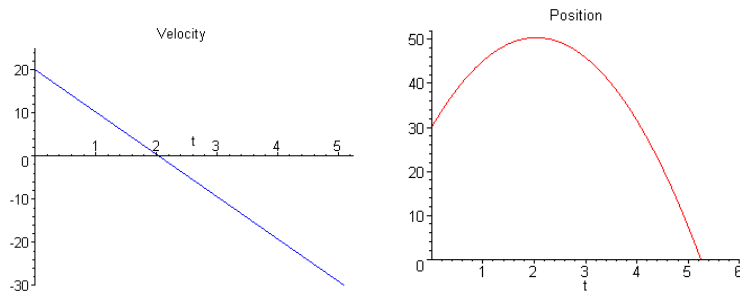

22(a). The differential equation for the motion is  $m dv/dt = -v/30 - mg$ . Given the initial condition  $v(0) = 20 \text{ m/s}$ , the solution is  $v(t) = -44.1 + 64.1 \exp(-t/4.5)$ . Setting  $v(t_1) = 0$ , the ball reaches the maximum height at  $t_1 = 1.683 \text{ sec}$ . Integrating  $v(t)$ , the position is given by  $x(t) = 318.45 - 44.1t - 288.45 \exp(-t/4.5)$ . Hence the maximum height is  $x(t_1) = 45.78 \text{ m}$ .

(b). Setting  $x(t_2) = 0$ , the ball hits the ground at  $t_2 = 5.128 \text{ sec}$ .

(c).

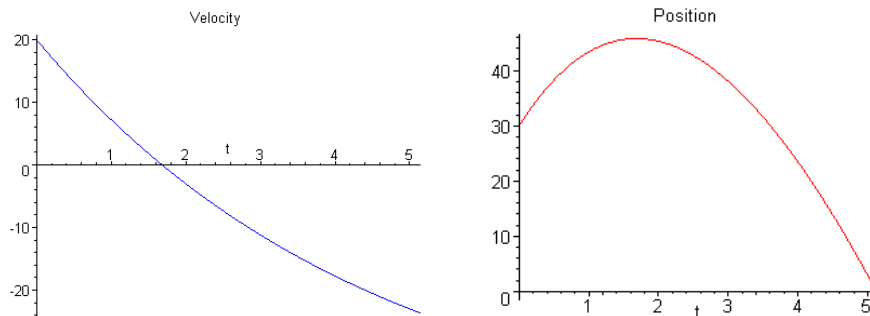

23(a). The differential equation for the upward motion is  $m dv/dt = -\mu v^2 - mg$ , in which  $\mu = 1/1325$ . This equation is separable, with  $\frac{m}{\mu v^2 + mg} dv = -dt$ . Integrating

both sides and invoking the initial condition,  $v(t) = 44.133 \tan(.425 - .222t)$ . Setting  $v(t_1) = 0$ , the ball reaches the maximum height at  $t_1 = 1.916 \text{ sec}$ . Integrating  $v(t)$ , the position is given by  $x(t) = 198.75 \ln[\cos(0.222t - 0.425)] + 48.57$ . Therefore the *maximum height* is  $x(t_1) = 48.56 \text{ m}$ .

(b). The differential equation for the *downward* motion is  $m \, dv/dt = +\mu v^2 - mg$ . This equation is also separable, with  $\frac{m}{mg - \mu v^2} dv = -dt$ . For convenience, set  $t = 0$  at the *top* of the trajectory. The new initial condition becomes  $v(0) = 0$ . Integrating both sides and invoking the initial condition, we obtain  $\ln[(44.13 - v)/(44.13 + v)] = t/2.25$ .

Solving for the velocity,  $v(t) = 44.13(1 - e^{t/2.25})/(1 + e^{t/2.25})$ . Integrating  $v(t)$ , the position is given by  $x(t) = 99.29 \ln[e^{t/2.25}/(1 + e^{t/2.25})^2] + 186.2$ . To estimate the *duration* of the downward motion, set  $x(t_2) = 0$ , resulting in  $t_2 = 3.276 \text{ sec}$ . Hence the *total time* that the ball remains in the air is  $t_1 + t_2 = 5.192 \text{ sec}$ .

(c).

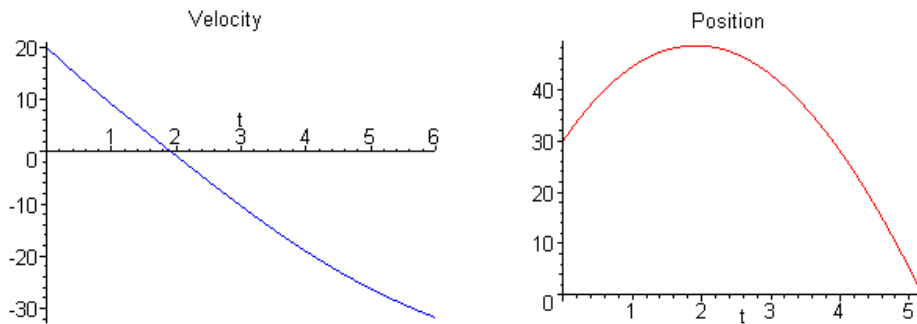

24(a). Measure the positive direction of motion *downward*. Based on Newton's 2nd law, the equation of motion is given by

$$m \frac{dv}{dt} = \begin{cases} -0.75v + mg & , 0 < t < 10 \\ -12v + mg & , t > 10 \end{cases} .$$

Note that gravity acts in the *positive* direction, and the drag force is *resistive*. During the first ten seconds of fall, the initial value problem is  $dv/dt = -v/7.5 + 32$ , with initial velocity  $v(0) = 0 \text{ fps}$ . This differential equation is separable and linear, with solution  $v(t) = 240(1 - e^{-t/7.5})$ . Hence  $v(10) = 176.7 \text{ fps}$ .

(b). Integrating the velocity, with  $x(t) = 0$ , the distance fallen is given by

$$x(t) = 240t + 1800 e^{-t/7.5} - 1800 .$$

Hence  $x(10) = 1074.5 \text{ ft}$ .

(c). For computational purposes, reset time to  $t = 0$ . For the remainder of the motion, the initial value problem is  $dv/dt = -32v/15 + 32$ , with specified initial velocity  $v(0) = 176.7 \text{ fps}$ . The solution is given by  $v(t) = 15 + 161.7 e^{-32t/15}$ . As  $t \rightarrow \infty$ ,  $v(t) \rightarrow v_L = 15 \text{ fps}$ . Integrating the velocity, with  $x(0) = 1074.5$ , the distance fallen after the parachute is open is given by  $x(t) = 15t - 75.8 e^{-32t/15} + 1150.3$ . To find the duration of the second part of the motion, estimate the root of the transcendental equation  $15T - 75.8 e^{-32T/15} + 1150.3 = 5000$ . The result is  $T = 256.6 \text{ sec}$ .

(d).

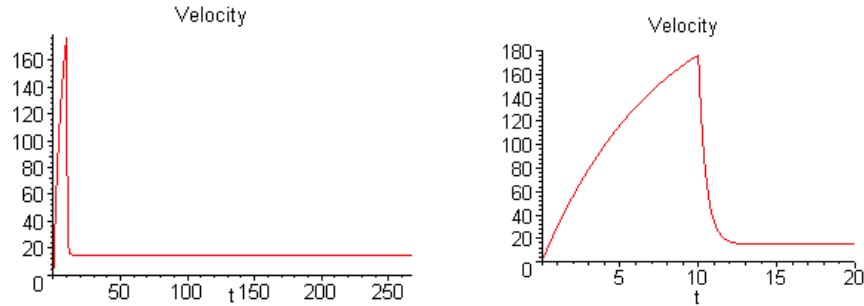

25(a). Measure the positive direction of motion *upward*. The equation of motion is given by  $mdv/dt = -kv - mg$ . The initial value problem is  $dv/dt = -kv/m - g$ , with  $v(0) = v_0$ . The solution is  $v(t) = -mg/k + (v_0 + mg/k)e^{-kt/m}$ . Setting  $v(t_m) = 0$ , the maximum height is reached at time  $t_m = (m/k)\ln[(mg + kv_0)/mg]$ . Integrating the velocity, the position of the body is

$$x(t) = -mgt/k + \left[ \left(\frac{m}{k}\right)^2 g + \frac{m v_0}{k} \right] (1 - e^{-kt/m}).$$

Hence the maximum height reached is

$$x_m = x(t_m) = \frac{m v_0}{k} - g \left(\frac{m}{k}\right)^2 \ln \left[ \frac{mg + k v_0}{mg} \right].$$

(b). Recall that for  $\delta \ll 1$ ,  $\ln(1 + \delta) = \delta - \frac{1}{2}\delta^2 + \frac{1}{3}\delta^3 - \frac{1}{4}\delta^4 + \dots$

26(b).  $\lim_{k \rightarrow 0} \frac{-mg + (k v_0 + mg)e^{-kt/m}}{k} = \lim_{k \rightarrow 0} -\frac{t}{m} (k v_0 + mg)e^{-kt/m} = -gt$ .

(c).  $\lim_{m \rightarrow 0} \left[ -\frac{mg}{k} + \left(\frac{mg}{k} + v_0\right)e^{-kt/m} \right] = 0$ , since  $\lim_{m \rightarrow 0} e^{-kt/m} = 0$ .

28(a). In terms of displacement, the differential equation is  $mv dv/dx = -kv + mg$ . This follows from the *chain rule*:  $\frac{dv}{dt} = \frac{dv}{dx} \frac{dx}{dt} = v \frac{dv}{dx}$ . The differential equation is separable, with

$$x(v) = -\frac{mv}{k} - \frac{m^2g}{k^2} \ln \left| \frac{mg - kv}{mg} \right|.$$

The inverse *exists*, since both  $x$  and  $v$  are monotone increasing. In terms of the given parameters,  $x(v) = -1.25v - 15.31 \ln|0.0816v - 1|$ .

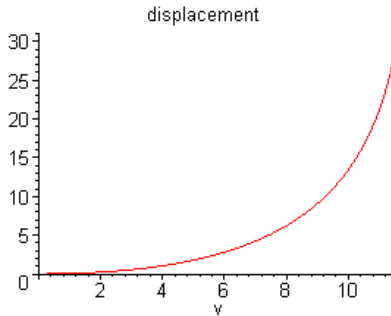

(b).  $x(10) = 13.45$  meters. The required value is  $k = 0.24$ .

(c). In part(a), set  $v = 10$  m/s and  $x = 10$  meters.

29(a). Let  $x$  represent the height above the earth's surface. The equation of motion is given by  $m \frac{dv}{dt} = -G \frac{Mm}{(R+x)^2}$ , in which  $G$  is the universal gravitational constant. The symbols  $M$  and  $R$  are the *mass* and *radius* of the earth, respectively. By the chain rule,

$$mv \frac{dv}{dx} = -G \frac{Mm}{(R+x)^2}.$$

This equation is separable, with  $v dv = -GM(R+x)^{-2} dx$ . Integrating both sides, and

invoking the initial condition  $v(0) = \sqrt{2gR}$ , the solution is  $v^2 = 2GM(R+x)^{-1} + 2gR - 2GM/R$ . From elementary physics, it follows that  $g = GM/R^2$ . Therefore  $v(x) = \sqrt{2g} \left[ R/\sqrt{R+x} \right]$ . (Note that  $g = 78,545$  mi/hr<sup>2</sup>.)

(b). We now consider  $dx/dt = \sqrt{2g} \left[ R/\sqrt{R+x} \right]$ . This equation is also separable, with  $\sqrt{R+x} dx = \sqrt{2g} R dt$ . By definition of the variable  $x$ , the initial condition is  $x(0) = 0$ . Integrating both sides, we obtain  $x(t) = \left[ \frac{3}{2} (\sqrt{2g} R t + \frac{2}{3} R^{3/2}) \right]^{2/3} - R$ . Setting the distance  $x(T) + R = 240,000$ , and solving for  $T$ , the duration of such a flight would be  $T \approx 49$  hours.

32(a). Both equations are linear and separable. The initial conditions are  $v(0) = u \cos A$  and  $w(0) = u \sin A$ . The two solutions are  $v(t) = u \cos A e^{-rt}$  and  $w(t) = -g/r + (u \sin A + g/r) e^{-rt}$ .



(b). Integrating the solutions in part(a), and invoking the initial conditions, the coordinates are  $x(t) = \frac{u}{r} \cos A(1 - e^{-rt})$  and

$$y(t) = -gt/r + (g + ur \sin A + hr^2)/r^2 - \left(\frac{u}{r} \sin A + g/r^2\right)e^{-rt}.$$

(c).

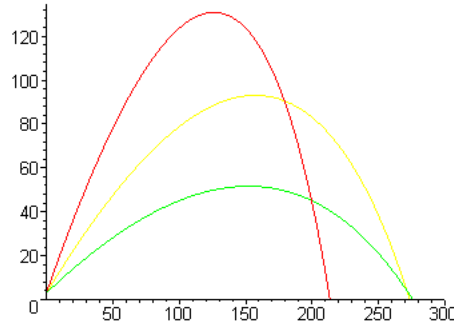

(d). Let  $T$  be the time that it takes the ball to go 350 ft horizontally. Then from above,  $e^{-T/5} = (u \cos A - 70)/u \cos A$ . At the same time, the height of the ball is given by  $y(T) = -160T + 267 + 125u \sin A - (800 + 5u \sin A)[(u \cos A - 70)/u \cos A]$ . Hence  $A$  and  $u$  must satisfy the inequality

$$800 \ln \left[ \frac{u \cos A - 70}{u \cos A} \right] + 267 + 125u \sin A - (800 + 5u \sin A) \left[ \frac{u \cos A - 70}{u \cos A} \right] \geq 10.$$

33(a). Solving equation (i),  $y'(x) = [(k^2 - y)/y]^{1/2}$ . The *positive* answer is chosen, since  $y$  is an *increasing* function of  $x$ .

(b). Let  $y = k^2 \sin^2 t$ . Then  $dy = 2k^2 \sin t \cos t dt$ . Substituting into the equation in part(a), we find that

$$\frac{2k^2 \sin t \cos t dt}{dx} = \frac{\cos t}{\sin t}.$$

Hence  $2k^2 \sin^2 t dt = dx$ .

(c). Letting  $\theta = 2t$ , we further obtain  $k^2 \sin^2 \frac{\theta}{2} d\theta = dx$ . Integrating both sides of the equation and noting that  $t = \theta = 0$  corresponds to the *origin*, we obtain the solutions  $x(\theta) = k^2(\theta - \sin \theta)/2$  and [from part(b)]  $y(\theta) = k^2(1 - \cos \theta)/2$ .

(d). Note that  $y/x = (1 - \cos \theta)/(\theta - \sin \theta)$ . Setting  $x = 1, y = 2$ , the solution of the equation  $(1 - \cos \theta)/(\theta - \sin \theta) = 2$  is  $\theta \approx 1.401$ . Substitution into either of the expressions yields  $k \approx 2.193$ .

## Section 2.4

2. Considering the roots of the coefficient of the leading term, the ODE has unique solutions on intervals *not* containing 0 or 4. Since  $2 \in (0, 4)$ , the initial value problem has a unique solution on the interval  $(0, 4)$ .

3. The function  $\tan t$  is discontinuous at *odd multiples* of  $\frac{\pi}{2}$ . Since  $\frac{\pi}{2} < \pi < \frac{3\pi}{2}$ , the initial value problem has a unique solution on the interval  $(\frac{\pi}{2}, \frac{3\pi}{2})$ .

5.  $p(t) = 2t/(4 - t^2)$  and  $g(t) = 3t^2/(4 - t^2)$ . These functions are discontinuous at  $x = \pm 2$ . The initial value problem has a unique solution on the interval  $(-2, 2)$ .

6. The function  $\ln t$  is defined and continuous on the interval  $(0, \infty)$ . Therefore the initial value problem has a unique solution on the interval  $(0, \infty)$ .

7. The function  $f(t, y)$  is continuous everywhere on the plane, *except* along the straight line  $y = -2t/5$ . The partial derivative  $\partial f/\partial y = -7t/(2t + 5y)^2$  has the *same* region of continuity.

9. The function  $f(t, y)$  is discontinuous along the coordinate axes, and on the hyperbola  $t^2 - y^2 = 1$ . Furthermore,

$$\frac{\partial f}{\partial y} = \frac{\pm 1}{y(1 - t^2 + y^2)} - 2 \frac{y \ln|ty|}{(1 - t^2 + y^2)^2}$$

has the *same* points of discontinuity.

10.  $f(t, y)$  is continuous everywhere on the plane. The partial derivative  $\partial f/\partial y$  is also continuous everywhere.

12. The function  $f(t, y)$  is discontinuous along the lines  $t = \pm k\pi$  and  $y = -1$ . The partial derivative  $\partial f/\partial y = \cot(t)/(1 + y)^2$  has the *same* region of continuity.

14. The equation is separable, with  $dy/y^2 = 2t dt$ . Integrating both sides, the solution is given by  $y(t) = y_0/(1 - y_0 t^2)$ . For  $y_0 > 0$ , solutions exist as long as  $t^2 < 1/y_0$ . For  $y_0 \leq 0$ , solutions are defined for *all*  $t$ .

15. The equation is separable, with  $dy/y^3 = -dt$ . Integrating both sides and invoking the initial condition,  $y(t) = y_0/\sqrt{2y_0 t + 1}$ . Solutions exist as long as  $2y_0 t + 1 > 0$ , that is,  $2y_0 t > -1$ . If  $y_0 > 0$ , solutions exist for  $t > -1/2y_0$ . If  $y_0 = 0$ , then the solution  $y(t) = 0$  exists for all  $t$ . If  $y_0 < 0$ , solutions exist for  $t < -1/2y_0$ .

16. The function  $f(t, y)$  is discontinuous along the straight lines  $t = -1$  and  $y = 0$ . The partial derivative  $\partial f/\partial y$  is discontinuous along the same lines. The equation is

separable, with  $y dy = t^2 dt/(1 + t^3)$ . Integrating and invoking the initial condition, the solution is  $y(t) = [\frac{2}{3} \ln|1 + t^3| + y_0^2]^{1/2}$ . Solutions exist as long as

$$\frac{2}{3} \ln|1 + t^3| + y_0^2 \geq 0,$$

that is,  $y_0^2 \geq -\frac{2}{3} \ln|1 + t^3|$ . For all  $y_0$  (it can be verified that  $y_0 = 0$  yields a valid solution, even though Theorem 2.4.2 does not guarantee one), solutions exist as long as  $|1 + t^3| \geq \exp(-3y_0^2/2)$ . From above, we must have  $t > -1$ . Hence the inequality may be written as  $t^3 \geq \exp(-3y_0^2/2) - 1$ . It follows that the solutions are valid for  $[\exp(-3y_0^2/2) - 1]^{1/3} < t < \infty$ .

17.

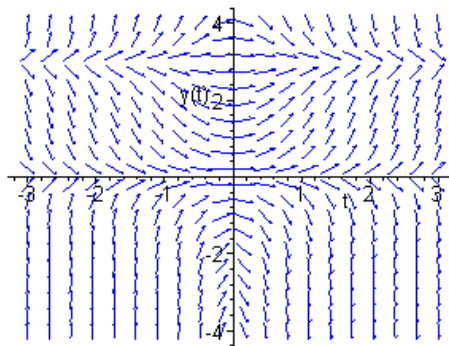

18.

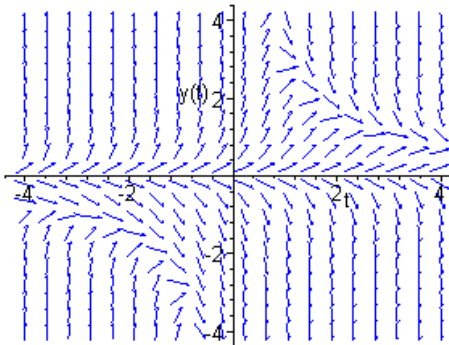

Based on the direction field, and the differential equation, for  $y_0 < 0$ , the slopes *eventually* become negative, and hence solutions tend to  $-\infty$ . For  $y_0 > 0$ , solutions increase without bound if  $t_0 < 0$ . Otherwise, the slopes *eventually* become negative, and solutions tend to zero. Furthermore,  $y_0 = 0$  is an *equilibrium solution*. Note that slopes are zero along the curves  $y = 0$  and  $ty = 3$ .

19.

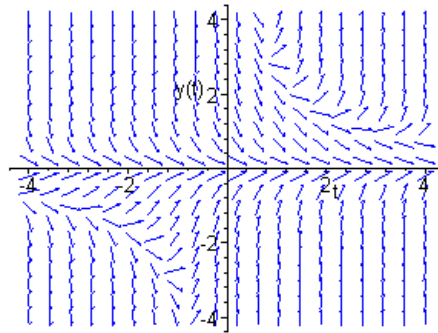

For initial conditions  $(t_0, y_0)$  satisfying  $ty < 3$ , the respective solutions all tend to zero. Solutions with initial conditions *above or below* the hyperbola  $ty = 3$  eventually tend to  $\pm\infty$ . Also,  $y_0 = 0$  is an *equilibrium solution*.

20.

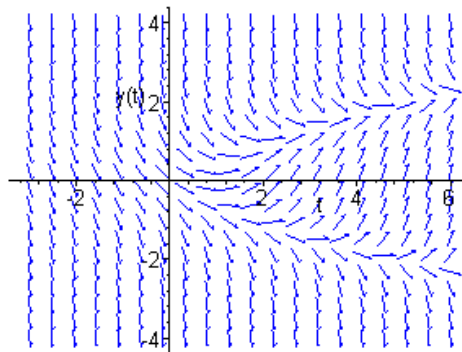

Solutions with  $t_0 < 0$  all tend to  $-\infty$ . Solutions with initial conditions  $(t_0, y_0)$  to the *right* of the parabola  $t = 1 + y^2$  asymptotically approach the parabola as  $t \rightarrow \infty$ . Integral curves with initial conditions *above* the parabola (and  $y_0 > 0$ ) also approach the curve. The slopes for solutions with initial conditions *below* the parabola (and  $y_0 < 0$ ) are all negative. These solutions tend to  $-\infty$ .

21. Define  $y_c(t) = \frac{2}{3}(t - c)^{3/2}u(t - c)$ , in which  $u(t)$  is the Heaviside step function. Note that  $y_c(c) = y_c(0) = 0$  and  $y_c(c + (3/2)^{2/3}) = 1$ .

(a). Let  $c = 1 - (3/2)^{2/3}$ .

(b). Let  $c = 2 - (3/2)^{2/3}$ .

(c). Observe that  $y_0(2) = \frac{2}{3}(2)^{3/2}$ ,  $y_c(t) < \frac{2}{3}(2)^{3/2}$  for  $0 < c < 2$ , and that  $y_c(2) = 0$  for  $c \geq 2$ . So for any  $c \geq 0$ ,  $\pm y_c(2) \in [-2, 2]$ .

26(a). Recalling Eq. (35) in Section 2.1,

$$y = \frac{1}{\mu(t)} \int \mu(s)g(s) ds + \frac{c}{\mu(t)}.$$

It is evident that  $y_1(t) = \frac{1}{\mu(t)}$  and  $y_2(t) = \frac{1}{\mu(t)} \int \mu(s)g(s) ds$ .

(b). By definition,  $\frac{1}{\mu(t)} = \exp(-\int p(t)dt)$ . Hence  $y_1' = -p(t) \frac{1}{\mu(t)} = -p(t)y_1$ . That is,  $y_1' + p(t)y_1 = 0$ .

(c).  $y_2' = \left(-p(t) \frac{1}{\mu(t)}\right) \int_0^t \mu(s)g(s) ds + \left(\frac{1}{\mu(t)}\right) \mu(t)g(t) = -p(t)y_2 + g(t)$ . That is,  $y_2' + p(t)y_2 = g(t)$ .

30. Since  $n = 3$ , set  $v = y^{-2}$ . It follows that  $\frac{dv}{dt} = -2y^{-3} \frac{dy}{dt}$  and  $\frac{dy}{dt} = -\frac{y^3}{2} \frac{dv}{dt}$ . Substitution into the differential equation yields  $-\frac{y^3}{2} \frac{dv}{dt} - \varepsilon y = -\sigma y^3$ , which further results in  $v' + 2\varepsilon v = 2\sigma$ . The latter differential equation is linear, and can be written as  $(e^{2\varepsilon t})' = 2\sigma$ . The solution is given by  $v(t) = 2\sigma t e^{-2\varepsilon t} + c e^{-2\varepsilon t}$ . Converting back to the original dependent variable,  $y = \pm v^{-1/2}$ .

31. Since  $n = 3$ , set  $v = y^{-2}$ . It follows that  $\frac{dv}{dt} = -2y^{-3} \frac{dy}{dt}$  and  $\frac{dy}{dt} = -\frac{y^3}{2} \frac{dv}{dt}$ . The differential equation is written as  $-\frac{y^3}{2} \frac{dv}{dt} - (\Gamma \cos t + T)y = \sigma y^3$ , which upon further substitution is  $v' + 2(\Gamma \cos t + T)v = 2$ . This ODE is linear, with integrating factor  $\mu(t) = \exp(2\int(\Gamma \cos t + T)dt) = \exp(-2\Gamma \sin t + 2Tt)$ . The solution is

$$v(t) = 2 \exp(2\Gamma \sin t - 2Tt) \int_0^t \exp(-2\Gamma \sin \tau + 2T\tau) d\tau + c \exp(-2\Gamma \sin t + 2Tt).$$

Converting back to the original dependent variable,  $y = \pm v^{-1/2}$ .

33. The solution of the initial value problem  $y_1' + 2y_1 = 0$ ,  $y_1(0) = 1$  is  $y_1(t) = e^{-2t}$ . Therefore  $y(1^-) = y_1(1) = e^{-2}$ . On the interval  $(1, \infty)$ , the differential equation is  $y_2' + y_2 = 0$ , with  $y_2(t) = ce^{-t}$ . Therefore  $y(1^+) = y_2(1) = ce^{-1}$ . Equating the limits  $y(1^-) = y(1^+)$ , we require that  $c = e^{-1}$ . Hence the global solution of the initial value problem is

$$y(t) = \begin{cases} e^{-2t}, & 0 \leq t \leq 1 \\ e^{-1-t}, & t > 1 \end{cases}.$$

Note the discontinuity of the derivative

$$y(t) = \begin{cases} -2e^{-2t}, & 0 < t < 1 \\ -e^{-1-t}, & t > 1 \end{cases}.$$

Section 2.5

1.

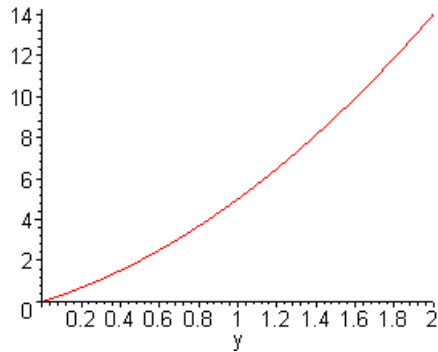

For  $y_0 \geq 0$ , the only equilibrium point is  $y^* = 0$ .  $f'(0) = a > 0$ , hence the equilibrium solution  $\phi(t) = 0$  is *unstable*.

2.

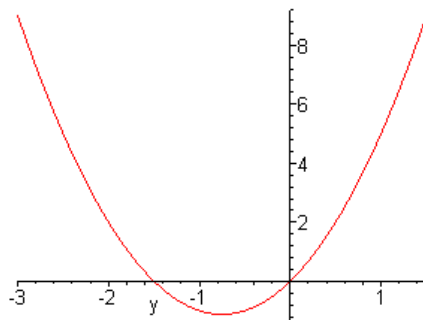

The equilibrium points are  $y^* = -a/b$  and  $y^* = 0$ .  $f'(-a/b) < 0$ , therefore the equilibrium solution  $\phi(t) = -a/b$  is *asymptotically stable*.

3.

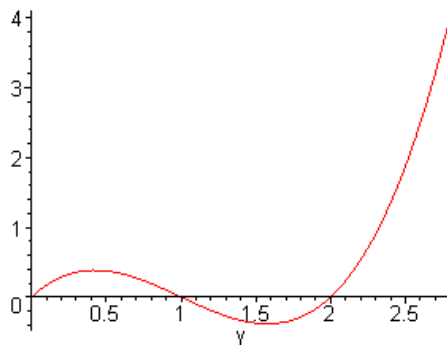

4.

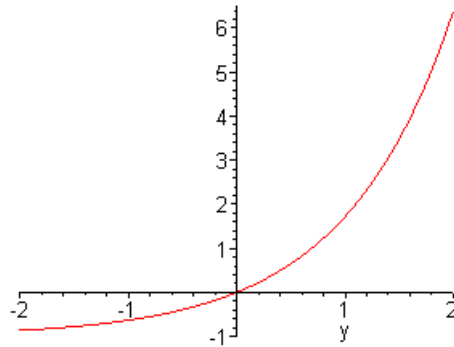

The only equilibrium point is  $y^* = 0$ .  $f'(0) > 0$ , hence the equilibrium solution  $\phi(t) = 0$  is *unstable*.

5.

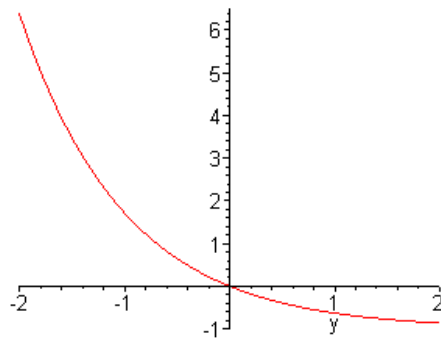

The only equilibrium point is  $y^* = 0$ .  $f'(0) < 0$ , hence the equilibrium solution  $\phi(t) = 0$  is *asymptotically stable*.

6.

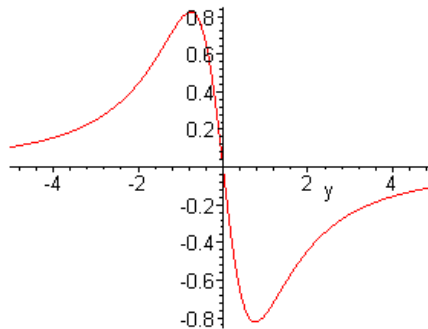

7(b).

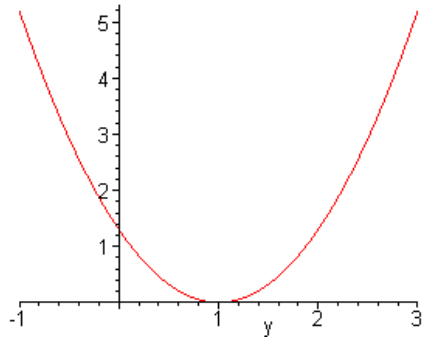

8.

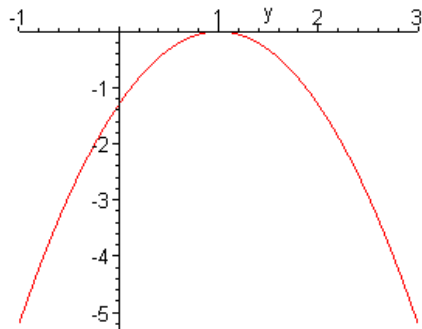

The only equilibrium point is  $y^* = 1$ . Note that  $f'(1) = 0$ , and that  $y' < 0$  for  $y \neq 1$ . As long as  $y_0 \neq 1$ , the corresponding solution is *monotone decreasing*. Hence the equilibrium solution  $\phi(t) = 1$  is *semistable*.

9.

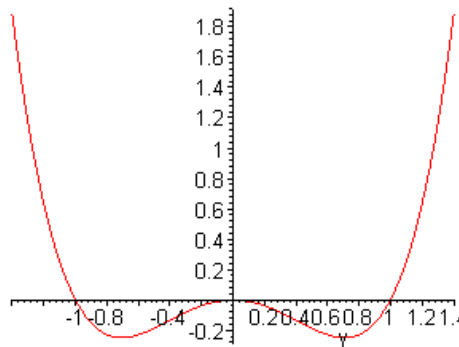



10.

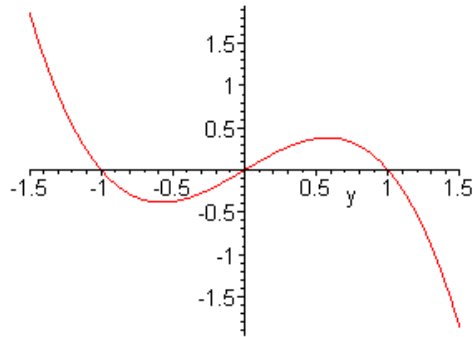

The equilibrium points are  $y^* = 0, \pm 1$ .  $f'(y) = 1 - 3y^2$ . The equilibrium solution  $\phi(t) = 0$  is *unstable*, and the remaining two are *asymptotically stable*.

11.

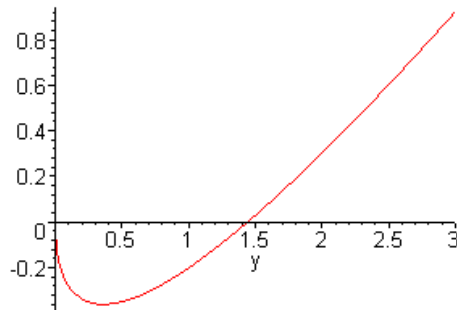

12.

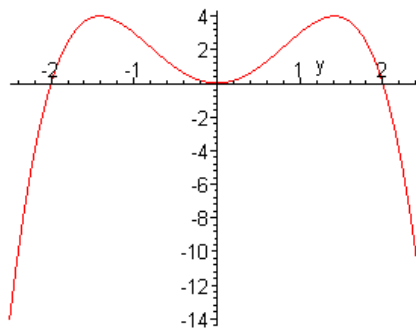

The equilibrium points are  $y^* = 0, \pm 2$ .  $f'(y) = 8y - 4y^3$ . The equilibrium solutions  $\phi(t) = -2$  and  $\phi(t) = +2$  are *unstable* and *asymptotically stable*, respectively. The equilibrium solution  $\phi(t) = 0$  is *semistable*.

13.

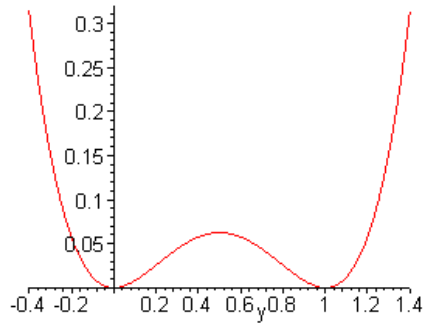

The equilibrium points are  $y^* = 0$  and  $1$ .  $f'(y) = 2y - 6y^2 + 4y^3$ . Both equilibrium solutions are *semistable*.

15(a). Inverting the Solution (11), Eq. (13) shows  $t$  as a function of the population  $y$  and the carrying capacity  $K$ . With  $y_0 = K/3$ ,

$$t = -\frac{1}{r} \ln \left| \frac{(1/3)[1 - (y/K)]}{(y/K)[1 - (1/3)]} \right|.$$

Setting  $y = 2y_0$ ,

$$\tau = -\frac{1}{r} \ln \left| \frac{(1/3)[1 - (2/3)]}{(2/3)[1 - (1/3)]} \right|.$$

That is,  $\tau = \frac{1}{r} \ln 4$ . If  $r = 0.025$  per year,  $\tau = 55.45$  years.

(b). In Eq. (13), set  $y_0/K = \alpha$  and  $y/K = \beta$ . As a result, we obtain

$$T = -\frac{1}{r} \ln \left| \frac{\alpha[1 - \beta]}{\beta[1 - \alpha]} \right|.$$

Given  $\alpha = 0.1$ ,  $\beta = 0.9$  and  $r = 0.025$  per year,  $\tau = 175.78$  years.

16(a).

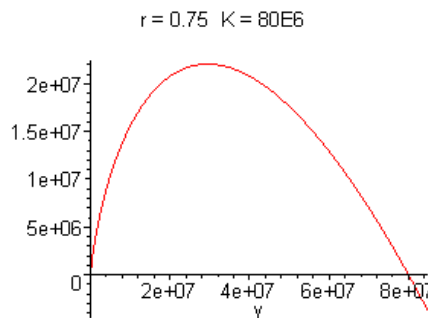

17. Consider the change of variable  $u = \ln(y/K)$ . Differentiating both sides with respect

to  $t$ ,  $u' = y'/y$ . Substitution into the Gompertz equation yields  $u' = -ru$ , with solution  $u = u_0 e^{-rt}$ . It follows that  $\ln(y/K) = \ln(y_0/K)e^{-rt}$ . That is,

$$\frac{y}{K} = \exp[\ln(y_0/K)e^{-rt}].$$

(a). Given  $K = 80.5 \times 10^6$ ,  $y_0/K = 0.25$  and  $r = 0.71$  per year,  $y(2) = 57.58 \times 10^6$ .

(b). Solving for  $t$ ,

$$t = -\frac{1}{r} \ln \left[ \frac{\ln(y/K)}{\ln(y_0/K)} \right].$$

Setting  $y(\tau) = 0.75K$ , the corresponding time is  $\tau = 2.21$  years.

19(a). The rate of *increase* of the volume is given by rate of *flow in* – rate of *flow out*. That is,  $dV/dt = k - \alpha a \sqrt{2gh}$ . Since the cross section is *constant*,  $dV/dt = Adh/dt$ . Hence the governing equation is  $dh/dt = (k - \alpha a \sqrt{2gh})/A$ .

(b). Setting  $dh/dt = 0$ , the equilibrium height is  $h_e = \frac{1}{2g} \left( \frac{k}{\alpha a} \right)^2$ . Furthermore, since  $f'(h_e) < 0$ , it follows that the equilibrium height is *asymptotically stable*.

(c). Based on the answer in part(b), the water level will intrinsically tend to approach  $h_e$ . Therefore the height of the tank must be *greater* than  $h_e$ ; that is,  $h_e < V/A$ .

22(a). The equilibrium points are at  $y^* = 0$  and  $y^* = 1$ . Since  $f'(y) = \alpha - 2\alpha y$ , the equilibrium solution  $\phi = 0$  is *unstable* and the equilibrium solution  $\phi = 1$  is *asymptotically stable*.

(b). The ODE is separable, with  $[y(1-y)]^{-1} dy = \alpha dt$ . Integrating both sides and invoking the initial condition, the solution is

$$y(t) = \frac{y_0 e^{\alpha t}}{1 - y_0 + y_0 e^{\alpha t}}.$$

It is evident that (independent of  $y_0$ )  $\lim_{t \rightarrow -\infty} y(t) = 0$  and  $\lim_{t \rightarrow \infty} y(t) = 1$ .

23(a).  $y(t) = y_0 e^{-\beta t}$ .

(b). From part(a),  $dx/dt = \alpha x y_0 e^{-\beta t}$ . Separating variables,  $dx/x = \alpha y_0 e^{-\beta t} dt$ . Integrating both sides, the solution is  $x(t) = x_0 \exp[\alpha y_0 / \beta (1 - e^{-\beta t})]$ .

(c). As  $t \rightarrow \infty$ ,  $y(t) \rightarrow 0$  and  $x(t) \rightarrow x_0 \exp(\alpha y_0 / \beta)$ . Over a *long* period of time, the

proportion of carriers *vanishes*. Therefore the proportion of the population that escapes the epidemic is the proportion of *susceptibles* left at that time,  $x_0 \exp(\alpha y_0/\beta)$ .

25(a). Note that  $f(x) = x[(R - R_c) - ax^2]$ , and  $f'(x) = (R - R_c) - 3ax^2$ . So if  $(R - R_c) < 0$ , the only equilibrium point is  $x^* = 0$ .  $f'(0) < 0$ , and hence the solution  $\phi(t) = 0$  is *asymptotically stable*.

(b). If  $(R - R_c) > 0$ , there are *three* equilibrium points  $x^* = 0, \pm\sqrt{(R - R_c)/a}$ . Now  $f'(0) > 0$ , and  $f'(\pm\sqrt{(R - R_c)/a}) < 0$ . Hence the solution  $\phi = 0$  is *unstable*, and the solutions  $\phi = \pm\sqrt{(R - R_c)/a}$  are *asymptotically stable*.

(c).

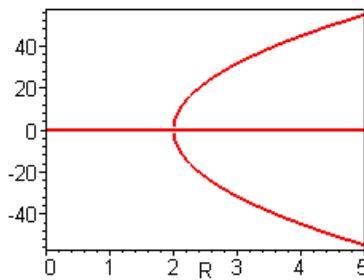

## Section 2.6

1.  $M(x, y) = 2x + 3$  and  $N(x, y) = 2y - 2$ . Since  $M_y = N_x = 0$ , the equation is *exact*. Integrating  $M$  with respect to  $x$ , while holding  $y$  constant, yields  $\psi(x, y) = x^2 + 3x + h(y)$ . Now  $\psi_y = h'(y)$ , and equating with  $N$  results in the possible function  $h(y) = y^2 - 2y$ . Hence  $\psi(x, y) = x^2 + 3x + y^2 - 2y$ , and the solution is defined *implicitly* as  $x^2 + 3x + y^2 - 2y = c$ .
2.  $M(x, y) = 2x + 4y$  and  $N(x, y) = 2x - 2y$ . Note that  $M_y \neq N_x$ , and hence the differential equation is *not exact*.
4. First divide both sides by  $(2xy + 2)$ . We now have  $M(x, y) = y$  and  $N(x, y) = x$ . Since  $M_y = N_x = 0$ , the resulting equation is *exact*. Integrating  $M$  with respect to  $x$ , while holding  $y$  constant, results in  $\psi(x, y) = xy + h(y)$ . Differentiating with respect to  $y$ ,  $\psi_y = x + h'(y)$ . Setting  $\psi_y = N$ , we find that  $h'(y) = 0$ , and hence  $h(y) = 0$  is acceptable. Therefore the solution is defined *implicitly* as  $xy = c$ . Note that if  $xy + 1 = 0$ , the equation is trivially satisfied.
6. Write the given equation as  $(ax - by)dx + (bx - cy)dy$ . Now  $M(x, y) = ax - by$  and  $N(x, y) = bx - cy$ . Since  $M_y \neq N_x$ , the differential equation is *not exact*.
8.  $M(x, y) = e^x \sin y + 3y$  and  $N(x, y) = -3x + e^x \sin y$ . Note that  $M_y \neq N_x$ , and hence the differential equation is *not exact*.
10.  $M(x, y) = y/x + 6x$  and  $N(x, y) = \ln x - 2$ . Since  $M_y = N_x = 1/x$ , the given equation is *exact*. Integrating  $N$  with respect to  $y$ , while holding  $x$  constant, results in  $\psi(x, y) = y \ln x - 2y + h(x)$ . Differentiating with respect to  $x$ ,  $\psi_x = y/x + h'(x)$ . Setting  $\psi_x = M$ , we find that  $h'(x) = 6x$ , and hence  $h(x) = 3x^2$ . Therefore the solution is defined *implicitly* as  $3x^2 + y \ln x - 2y = c$ .
11.  $M(x, y) = x \ln y + xy$  and  $N(x, y) = y \ln x + xy$ . Note that  $M_y \neq N_x$ , and hence the differential equation is *not exact*.
13.  $M(x, y) = 2x - y$  and  $N(x, y) = 2y - x$ . Since  $M_y = N_x = -1$ , the equation is *exact*. Integrating  $M$  with respect to  $x$ , while holding  $y$  constant, yields  $\psi(x, y) = x^2 - xy + h(y)$ . Now  $\psi_y = -x + h'(y)$ . Equating  $\psi_y$  with  $N$  results in  $h'(y) = 2y$ , and hence  $h(y) = y^2$ . Thus  $\psi(x, y) = x^2 - xy + y^2$ , and the solution is given *implicitly* as  $x^2 - xy + y^2 = c$ . Invoking the initial condition  $y(1) = 3$ , the specific solution is  $x^2 - xy + y^2 = 7$ . The *explicit* form of the solution is  $y(x) = \frac{1}{2} \left[ x + \sqrt{28 - 3x^2} \right]$ . Hence the solution is valid as long as  $3x^2 \leq 28$ .
16.  $M(x, y) = y e^{2xy} + x$  and  $N(x, y) = bx e^{2xy}$ . Note that  $M_y = e^{2xy} + 2xy e^{2xy}$ , and  $N_x = b e^{2xy} + 2bxy e^{2xy}$ . The given equation is *exact*, as long as  $b = 1$ . Integrating

$N$  with respect to  $y$ , while holding  $x$  constant, results in  $\psi(x, y) = e^{2xy}/2 + h(x)$ . Now differentiating with respect to  $x$ ,  $\psi_x = ye^{2xy} + h'(x)$ . Setting  $\psi_x = M$ , we find that  $h'(x) = x$ , and hence  $h(x) = x^2/2$ . Conclude that  $\psi(x, y) = e^{2xy}/2 + x^2/2$ . Hence the solution is given *implicitly* as  $e^{2xy} + x^2 = c$ .

17. Integrating  $\psi_y = N$ , while holding  $x$  constant, yields

$$\psi(x, y) = \int N(x, y)dy + h(x).$$

Taking the partial derivative with respect to  $x$ ,  $\psi_x = \int \frac{\partial}{\partial x} N(x, y)dy + h'(x)$ . Now set  $\psi_x = M(x, y)$  and therefore  $h'(x) = M(x, y) - \int \frac{\partial}{\partial x} N(x, y)dy$ . Based on the fact that  $M_y = N_x$ , it follows that  $\frac{\partial}{\partial y}[h'(x)] = 0$ . Hence the expression for  $h'(x)$  can be integrated to obtain

$$h(x) = \int M(x, y)dx - \int \left[ \int \frac{\partial}{\partial x} N(x, y)dy \right] dx.$$

18. Observe that  $\frac{\partial}{\partial y}[M(x)] = \frac{\partial}{\partial x}[N(y)] = 0$ .

20.  $M_y = y^{-1}\cos y - y^{-2}\sin y$  and  $N_x = -2e^{-x}(\cos x + \sin x)/y$ . Multiplying both sides by the integrating factor  $\mu(x, y) = ye^x$ , the given equation can be written as  $(e^x \sin y - 2y \sin x)dx + (e^x \cos y + 2\cos x)dy = 0$ . Let  $\overline{M} = \mu M$  and  $\overline{N} = \mu N$ . Observe that  $\overline{M}_y = \overline{N}_x$ , and hence the latter ODE is *exact*. Integrating  $\overline{N}$  with respect to  $y$ , while holding  $x$  constant, results in  $\psi(x, y) = e^x \sin y + 2y \cos x + h(x)$ . Now differentiating with respect to  $x$ ,  $\psi_x = e^x \sin y - 2y \sin x + h'(x)$ . Setting  $\psi_x = \overline{M}$ , we find that  $h'(x) = 0$ , and hence  $h(x) = 0$  is feasible. Hence the solution of the given equation is defined *implicitly* by  $e^x \sin y + 2y \cos x = \beta$ .

21.  $M_y = 1$  and  $N_x = 2$ . Multiply both sides by the integrating factor  $\mu(x, y) = y$  to obtain  $y^2 dx + (2xy - y^2 e^y)dy = 0$ . Let  $\overline{M} = yM$  and  $\overline{N} = yN$ . It is easy to see that  $\overline{M}_y = \overline{N}_x$ , and hence the latter ODE is *exact*. Integrating  $\overline{M}$  with respect to  $x$  yields  $\psi(x, y) = xy^2 + h(y)$ . Equating  $\psi_y$  with  $\overline{N}$  results in  $h'(y) = -y^2 e^y$ , and hence  $h(y) = -e^y(y^2 - 2y + 2)$ . Thus  $\psi(x, y) = xy^2 - e^y(y^2 - 2y + 2)$ , and the solution is defined *implicitly* by  $xy^2 - e^y(y^2 - 2y + 2) = c$ .

24. The equation  $\mu M + \mu N y' = 0$  has an integrating factor if  $(\mu M)_y = (\mu N)_x$ , that is,  $\mu_y M - \mu_x N = \mu N_x - \mu M_y$ . Suppose that  $N_x - M_y = R(xM - yN)$ , in which  $R$  is some function depending *only* on the quantity  $z = xy$ . It follows that the modified form of the equation is *exact*, if  $\mu_y M - \mu_x N = \mu R(xM - yN) = R(\mu xM - \mu yN)$ . This relation is satisfied if  $\mu_y = (\mu x)R$  and  $\mu_x = (\mu y)R$ . Now consider  $\mu = \mu(xy)$ . Then the partial derivatives are  $\mu_x = \mu' y$  and  $\mu_y = \mu' x$ . Note that  $\mu' = d\mu/dz$ . Thus  $\mu$  must satisfy  $\mu'(z) = R(z)$ . The latter equation is *separable*, with  $d\mu = R(z)dz$ , and  $\mu(z) = \int R(z)dz$ . Therefore, given  $R = R(xy)$ , it is possible to determine  $\mu = \mu(xy)$  which becomes an integrating factor of the differential equation.

28. The equation is not exact, since  $N_x - M_y = 2y - 1$ . However,  $(N_x - M_y)/M = (2y - 1)/y$  is a function of  $y$  alone. Hence there exists  $\mu = \mu(y)$ , which is a solution of the differential equation  $\mu' = (2 - 1/y)\mu$ . The latter equation is *separable*, with  $d\mu/\mu = 2 - 1/y$ . One solution is  $\mu(y) = \exp(2y - \ln y) = e^{2y}/y$ . Now rewrite the given ODE as  $e^{2y}dx + (2xe^{2y} - 1/y)dy = 0$ . This equation is *exact*, and it is easy to see that  $\psi(x, y) = xe^{2y} - \ln y$ . Therefore the solution of the given equation is defined implicitly by  $xe^{2y} - \ln y = c$ .

30. The given equation is not exact, since  $N_x - M_y = 8x^3/y^3 + 6/y^2$ . But note that  $(N_x - M_y)/M = 2/y$  is a function of  $y$  alone, and hence there is an integrating factor  $\mu = \mu(y)$ . Solving the equation  $\mu' = (2/y)\mu$ , an integrating factor is  $\mu(y) = y^2$ . Now rewrite the differential equation as  $(4x^3 + 3y)dx + (3x + 4y^3)dy = 0$ . By inspection,  $\psi(x, y) = x^4 + 3xy + y^4$ , and the solution of the given equation is defined implicitly by  $x^4 + 3xy + y^4 = c$ .

32. Multiplying both sides of the ODE by  $\mu = [xy(2x + y)]^{-1}$ , the given equation is equivalent to  $[(3x + y)/(2x^2 + xy)]dx + [(x + y)/(2xy + y^2)]dy = 0$ . Rewrite the differential equation as

$$\left[ \frac{2}{x} + \frac{2}{2x + y} \right] dx + \left[ \frac{1}{y} + \frac{1}{2x + y} \right] dy = 0.$$

It is easy to see that  $M_y = N_x$ . Integrating  $M$  with respect to  $x$ , while keeping  $y$  constant, results in  $\psi(x, y) = 2\ln|x| + \ln|2x + y| + h(y)$ . Now taking the partial derivative with respect to  $y$ ,  $\psi_y = (2x + y)^{-1} + h'(y)$ . Setting  $\psi_y = N$ , we find that  $h'(y) = 1/y$ , and hence  $h(y) = \ln|y|$ . Therefore

$$\psi(x, y) = 2\ln|x| + \ln|2x + y| + \ln|y|,$$

and the solution of the given equation is defined implicitly by  $2x^3y + x^2y^2 = c$ .

**Section 2.7**

2(a). The Euler formula is  $y_{n+1} = y_n + h(2y_n - 1) = (1 + 2h)y_n - h$ .

(d). The differential equation is *linear*, with solution  $y(t) = (1 + e^{2t})/2$ .

4(a). The Euler formula is  $y_{n+1} = (1 - 2h)y_n + 3h \cos t_n$ .

(d). The exact solution is  $y(t) = (6\cos t + 3\sin t - 6e^{-2t})/5$ .

5.

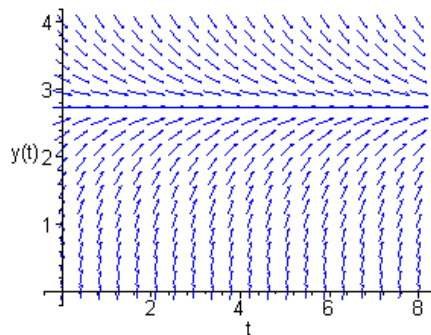

All solutions seem to converge to  $\phi(t) = 25/9$ .

6.

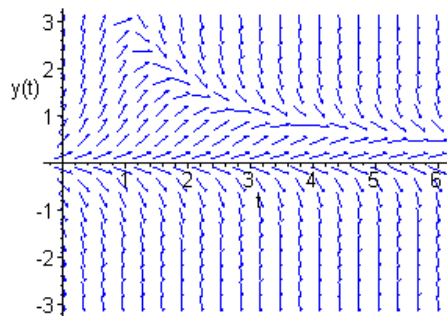

Solutions with *positive* initial conditions seem to converge to a specific function. On the other hand, solutions with *negative* coefficients decrease without bound.  $\phi(t) = 0$  is an equilibrium solution.

7.



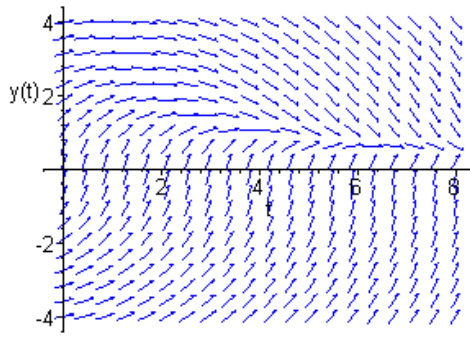

All solutions seem to converge to a specific function.

8.

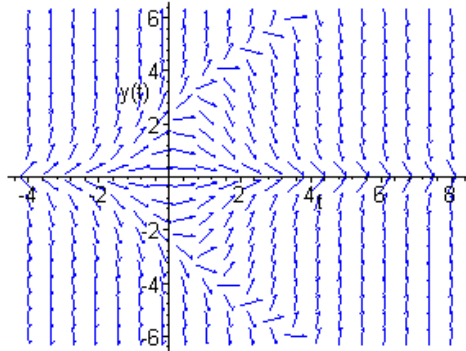

Solutions with initial conditions to the 'left' of the curve  $t = 0.1y^2$  seem to diverge. On the other hand, solutions to the 'right' of the curve seem to converge to zero. Also,  $\phi(t)$  is an equilibrium solution.

9.

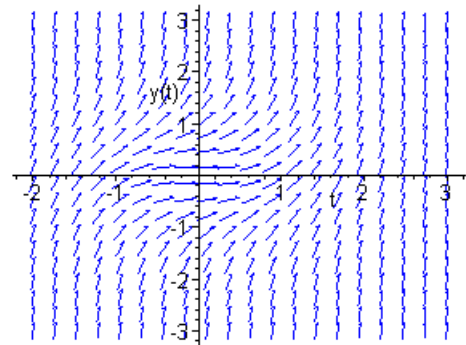

All solutions seem to diverge.

10.

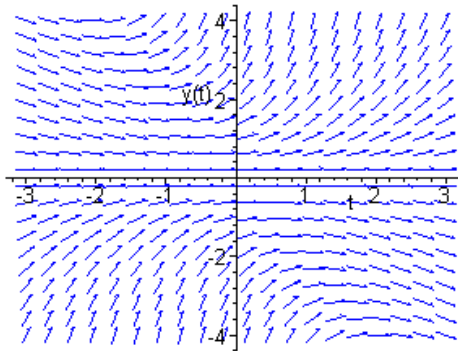

Solutions with *positive* initial conditions increase without bound. Solutions with *negative* initial conditions decrease without bound. Note that  $\phi(t) = 0$  is an equilibrium solution.

11. The Euler formula is  $y_{n+1} = y_n - 3h\sqrt{y_n} + 5h$ . The initial value is  $y_0 = 2$ .

12. The iteration formula is  $y_{n+1} = (1 + 3h)y_n - h t_n y_n^2$ .  $(t_0, y_0) = (0, 0.5)$ .

14. The iteration formula is  $y_{n+1} = (1 - h t_n)y_n + h y_n^3 / 10$ .  $(t_0, y_0) = (0, 1)$ .

17. The Euler formula is

$$y_{n+1} = y_n + \frac{h(y_n^2 + 2t_n y_n)}{3 + t_n^2}.$$

The initial point is  $(t_0, y_0) = (1, 2)$ .

18(a). See Problem 8.

19(a).

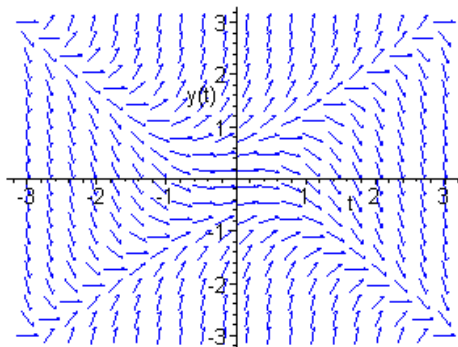

(b). The iteration formula is  $y_{n+1} = y_n + h y_n^2 - h t_n^2$ . The critical value of  $\alpha$  appears to be near  $\alpha_0 \approx 0.6815$ . For  $y_0 > \alpha_0$ , the iterations diverge.

20(a). The ODE is *linear*, with general solution  $y(t) = t + c e^t$ . Invoking the specified initial condition,  $y(t_0) = y_0$ , we have  $y_0 = t_0 + c e^{t_0}$ . Hence  $c = (y_0 - t_0)e^{-t_0}$ . Thus the solution is given by  $\phi(t) = (y_0 - t_0)e^{t-t_0} + t$ .

(b). The Euler formula is  $y_{n+1} = (1 + h)y_n + h - h t_n$ . Now set  $k = n + 1$ .

(c). We have  $y_1 = (1 + h)y_0 + h - h t_0 = (1 + h)y_0 + (t_1 - t_0) - h t_0$ . Rearranging the terms,  $y_1 = (1 + h)(y_0 - t_0) + t_1$ . Now suppose that  $y_k = (1 + h)^k(y_0 - t_0) + t_k$ , for some  $k \geq 1$ . Then  $y_{k+1} = (1 + h)y_k + h - h t_k$ . Substituting for  $y_k$ , we find that  $y_{k+1} = (1 + h)^{k+1}(y_0 - t_0) + (1 + h)t_k + h - h t_k = (1 + h)^{k+1}(y_0 - t_0) + t_k + h$ . Noting that  $t_{k+1} = t_k + h$ , the result is verified.

(d). Substituting  $h = (t - t_0)/n$ , with  $t_n = t$ ,

$$y_n = \left(1 + \frac{t - t_0}{n}\right)^n (y_0 - t_0) + t.$$

Taking the limit of both sides, as  $n \rightarrow \infty$ , and using the fact that  $\lim_{n \rightarrow \infty} (1 + a/n)^n = e^a$ , pointwise convergence is proved.

21. The exact solution is  $\phi(t) = e^t$ . The Euler formula is  $y_{n+1} = (1 + h)y_n$ . It is easy to see that  $y_n = (1 + h)^n y_0 = (1 + h)^n$ . Given  $t > 0$ , set  $h = t/n$ . Taking the limit, we find that  $\lim_{n \rightarrow \infty} y_n = \lim_{n \rightarrow \infty} (1 + t/n)^n = e^t$ .

23. The exact solution is  $\phi(t) = t/2 + e^{2t}$ . The Euler formula is  $y_{n+1} = (1 + 2h)y_n + h/2 - h t_n$ . Since  $y_0 = 1$ ,  $y_1 = (1 + 2h) + h/2 = (1 + 2h) + t_1/2$ . It is easy to show by mathematical induction, that  $y_n = (1 + 2h)^n + t_n/2$ . For  $t > 0$ , set  $h = t/n$  and thus  $t_n = t$ . Taking the limit, we find that  $\lim_{n \rightarrow \infty} y_n = \lim_{n \rightarrow \infty} [(1 + 2t/n)^n + t/2] = e^{2t} + t/2$ . Hence pointwise convergence is proved.

**Section 2.8**

2. Let  $z = y - 3$  and  $\tau = t + 1$ . It follows that  $dz/d\tau = (dz/dt)(dt/d\tau) = dz/dt$ . Furthermore,  $dz/dt = dy/dt = 1 - y^3$ . Hence  $dz/d\tau = 1 - (z + 3)^3$ . The new initial condition is  $z(\tau = 0) = 0$ .

3. The approximating functions are defined recursively by  $\phi_{n+1}(t) = \int_0^t 2[\phi_n(s) + 1]ds$ . Setting  $\phi_0(t) = 0$ ,  $\phi_1(t) = 2t$ . Continuing,  $\phi_2(t) = 2t^2 + 2t$ ,  $\phi_3(t) = \frac{4}{3}t^3 + 2t^2 + 2t$ ,  $\phi_4(t) = \frac{2}{3}t^4 + \frac{4}{3}t^3 + 2t^2 + 2t, \dots$ . Given convergence, set

$$\begin{aligned} \phi(t) &= \phi_1(t) + \sum_{k=1}^{\infty} [\phi_{k+1}(t) - \phi_k(t)] \\ &= 2t + \sum_{k=2}^{\infty} \frac{a_k}{k!} t^k. \end{aligned}$$

Comparing coefficients,  $a_3/3! = 4/3$ ,  $a_4/4! = 2/3, \dots$ . It follows that  $a_3 = 8$ ,  $a_4 = 16$ , and so on. We find that in general, that  $a_k = 2^k$ . Hence

$$\begin{aligned} \phi(t) &= \sum_{k=1}^{\infty} \frac{2^k}{k!} t^k \\ &= e^{2t} - 1. \end{aligned}$$

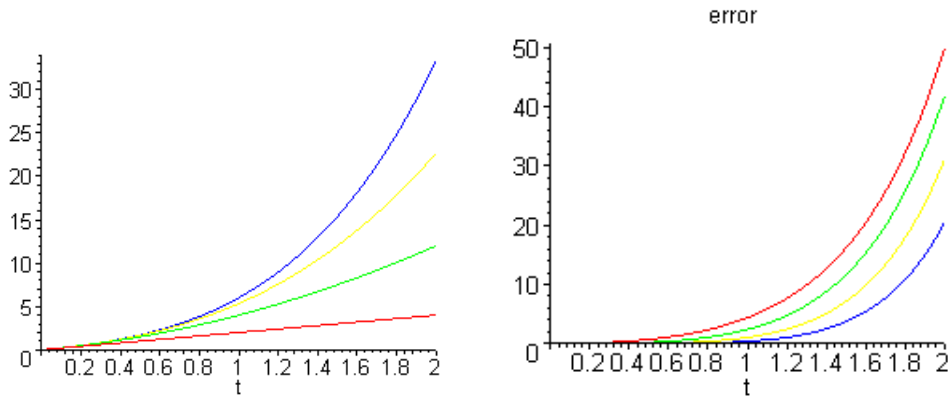

5. The approximating functions are defined recursively by

$$\phi_{n+1}(t) = \int_0^t [-\phi_n(s)/2 + s]ds.$$

Setting  $\phi_0(t) = 0$ ,  $\phi_1(t) = t^2/2$ . Continuing,  $\phi_2(t) = t^2/2 - t^3/12$ ,  $\phi_3(t) = t^2/2 - t^3/12 + t^4/96$ ,  $\phi_4(t) = t^2/2 - t^3/12 + t^4/96 - t^5/960, \dots$ . Given convergence, set

$$\begin{aligned}\phi(t) &= \phi_1(t) + \sum_{k=1}^{\infty} [\phi_{k+1}(t) - \phi_k(t)] \\ &= t^2/2 + \sum_{k=3}^{\infty} \frac{a_k}{k!} t^k.\end{aligned}$$

Comparing coefficients,  $a_3/3! = -1/12$ ,  $a_4/4! = 1/96$ ,  $a_5/5! = -1/960$ ,  $\dots$ . We find that  $a_3 = -1/2$ ,  $a_4 = 1/4$ ,  $a_5 = -1/8$ ,  $\dots$ . In general,  $a_k = 2^{-k+1}$ . Hence

$$\begin{aligned}\phi(t) &= \sum_{k=2}^{\infty} \frac{2^{-k+2}}{k!} (-t)^k \\ &= 4e^{-t/2} + 2t - 4.\end{aligned}$$

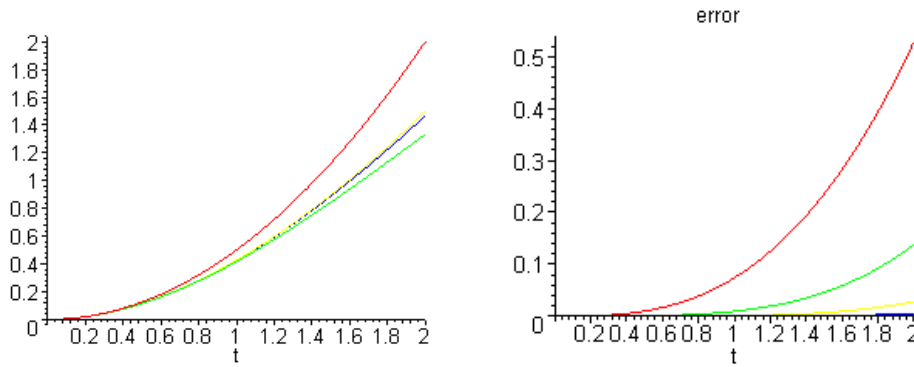

6. The approximating functions are defined recursively by

$$\phi_{n+1}(t) = \int_0^t [\phi_n(s) + 1 - s] ds.$$

Setting  $\phi_0(t) = 0$ ,  $\phi_1(t) = t - t^2/2$ ,  $\phi_2(t) = t - t^3/6$ ,  $\phi_3(t) = t - t^4/24$ ,  $\phi_4(t) = t - t^5/120$ ,  $\dots$ . Given convergence, set

$$\begin{aligned}\phi(t) &= \phi_1(t) + \sum_{k=1}^{\infty} [\phi_{k+1}(t) - \phi_k(t)] \\ &= t - t^2/2 + [t^2/2 - t^3/6] + [t^3/6 - t^4/24] + \dots \\ &= t + 0 + 0 + \dots.\end{aligned}$$

Note that the terms can be rearranged, as long as the series converges *uniformly*.

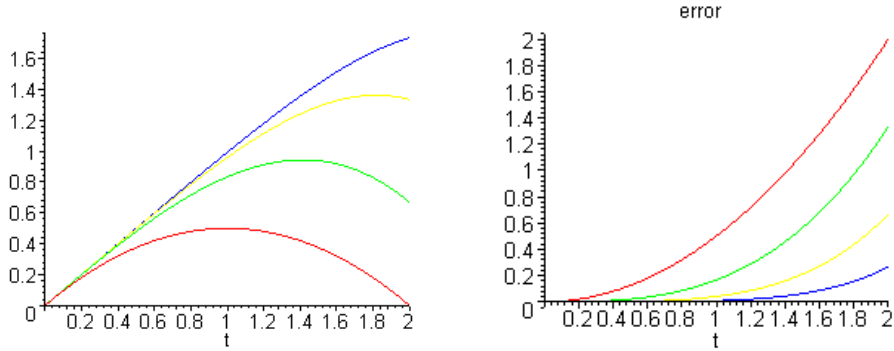

8(a). The approximating functions are defined recursively by

$$\phi_{n+1}(t) = \int_0^t [s^2 \phi_n(s) - s] ds.$$

Set  $\phi_0(t) = 0$ . The iterates are given by  $\phi_1(t) = -t^2/2$ ,  $\phi_2(t) = -t^2/2 - t^5/10$ ,  $\phi_3(t) = -t^2/2 - t^5/10 - t^8/80$ ,  $\phi_4(t) = -t^2/2 - t^5/10 - t^8/80 - t^{11}/880, \dots$ . Upon inspection, it becomes apparent that

$$\begin{aligned} \phi_n(t) &= -t^2 \left[ \frac{1}{2} + \frac{t^3}{2 \cdot 5} + \frac{t^6}{2 \cdot 5 \cdot 8} + \dots + \frac{(t^3)^{n-1}}{2 \cdot 5 \cdot 8 \dots [2 + 3(n-1)]} \right] \\ &= -t^2 \sum_{k=1}^n \frac{(t^3)^{k-1}}{2 \cdot 5 \cdot 8 \dots [2 + 3(k-1)]}. \end{aligned}$$

(b).

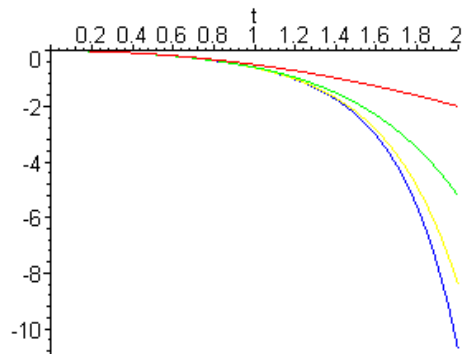

The iterates appear to be converging.

9(a). The approximating functions are defined recursively by

$$\phi_{n+1}(t) = \int_0^t [s^2 + \phi_n^2(s)] ds.$$

Set  $\phi_0(t) = 0$ . The first three iterates are given by  $\phi_1(t) = t^3/3$ ,  $\phi_2(t) = t^3/3 + t^7/63$ ,  $\phi_3(t) = t^3/3 + t^7/63 + 2t^{11}/2079 + t^{15}/59535$ .

(b).

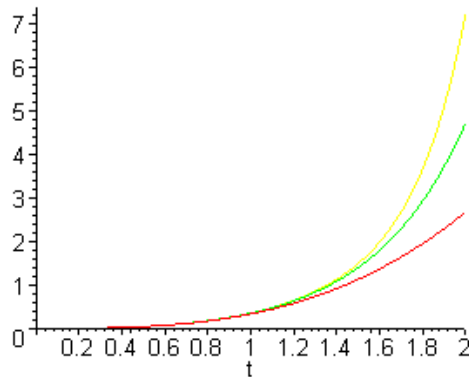

The iterates appear to be converging.

10(a). The approximating functions are defined recursively by

$$\phi_{n+1}(t) = \int_0^t [1 - \phi_n^3(s)] ds.$$

Set  $\phi_0(t) = 0$ . The first three iterates are given by  $\phi_1(t) = t$ ,  $\phi_2(t) = t - t^4/4$ ,  $\phi_3(t) = t - t^4/4 + 3t^7/28 - 3t^{10}/160 + t^{13}/833$ .

(b).

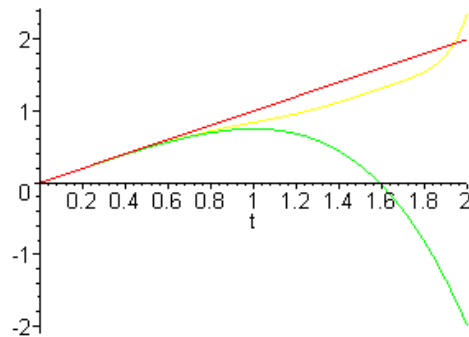

The approximations appear to be diverging.

12(a). The approximating functions are defined recursively by

$$\phi_{n+1}(t) = \int_0^t \left[ \frac{3s^2 + 4s + 2}{2(\phi_n(s) - 1)} \right] ds.$$

Note that  $1/(2y - 2) = -\frac{1}{2} \sum_{k=0}^6 y^k + O(y^7)$ . For computational purposes, replace the above iteration formula by

$$\phi_{n+1}(t) = -\frac{1}{2} \int_0^t \left[ (3s^2 + 4s + 2) \sum_{k=0}^6 \phi_n^k(s) \right] ds.$$

Set  $\phi_0(t) = 0$ . The first four approximations are given by  $\phi_1(t) = -t - t^2 - t^3/2$ ,  
 $\phi_2(t) = -t - t^2/2 + t^3/6 + t^4/4 - t^5/5 - t^6/24 + \dots$ ,  
 $\phi_3(t) = -t - t^2/2 + t^4/12 - 3t^5/20 + 4t^6/45 + \dots$ ,  
 $\phi_4(t) = -t - t^2/2 + t^4/8 - 7t^5/60 + t^6/15 + \dots$

(b).

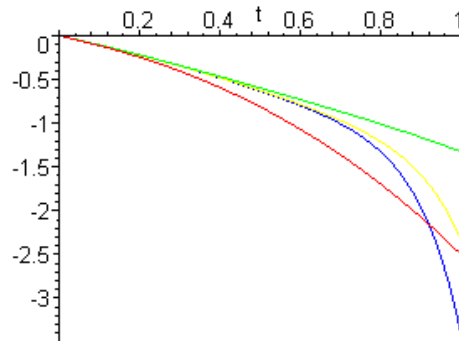

The approximations appear to be converging to the exact solution,

$$\phi(t) = 1 - \sqrt{1 + 2t + 2t^2 + t^3}.$$

13. Note that  $\phi_n(0) = 0$  and  $\phi_n(1) = 1, \forall n \geq 1$ . Let  $a \in (0, 1)$ . Then  $\phi_n(a) = a^n$ . Clearly,  $\lim_{n \rightarrow \infty} a^n = 0$ . Hence the assertion is true.

14(a).  $\phi_n(0) = 0, \forall n \geq 1$ . Let  $a \in (0, 1]$ . Then  $\phi_n(a) = 2na e^{-na^2} = 2na/e^{na^2}$ . Using l'Hospital's rule,  $\lim_{z \rightarrow \infty} 2az/e^{az^2} = \lim_{z \rightarrow \infty} 1/ze^{az^2} = 0$ . Hence  $\lim_{n \rightarrow \infty} \phi_n(a) = 0$ .

(b).  $\int_0^1 2nx e^{-nx^2} dx = -e^{-nx^2} \Big|_0^1 = 1 - e^{-n}$ . Therefore,

$$\lim_{n \rightarrow \infty} \int_0^1 \phi_n(x) dx \neq \int_0^1 \lim_{n \rightarrow \infty} \phi_n(x) dx.$$

15. Let  $t$  be fixed, such that  $(t, y_1), (t, y_2) \in D$ . Without loss of generality, assume that  $y_1 < y_2$ . Since  $f$  is differentiable with respect to  $y$ , the mean value theorem asserts that  $\exists \xi \in (y_1, y_2)$  such that  $f(t, y_1) - f(t, y_2) = f_y(t, \xi)(y_1 - y_2)$ . Taking the absolute value of both sides,  $|f(t, y_1) - f(t, y_2)| = |f_y(t, \xi)| |y_1 - y_2|$ . Since, by assumption,  $\partial f / \partial y$  is continuous in  $D$ ,  $f_y$  attains a *maximum* on any closed and bounded subset of  $D$ .



Hence  $|f(t, y_1) - f(t, y_2)| \leq K |y_1 - y_2|$ .

16. For a *sufficiently small* interval of  $t$ ,  $\phi_{n-1}(t), \phi_n(t) \in D$ . Since  $f$  satisfies a Lipschitz condition,  $|f(t, \phi_n(t)) - f(t, \phi_{n-1}(t))| \leq K |\phi_n(t) - \phi_{n-1}(t)|$ . Here  $K = \max |f_y|$ .

17(a).  $\phi_1(t) = \int_0^t f(s, 0) ds$ . Hence  $|\phi_1(t)| \leq \int_0^{|t|} |f(s, 0)| ds \leq \int_0^{|t|} M ds = M|t|$ , in which  $M$  is the maximum value of  $|f(t, y)|$  on  $D$ .

(b). By definition,  $\phi_2(t) - \phi_1(t) = \int_0^t [f(s, \phi_1(s)) - f(s, 0)] ds$ . Taking the absolute value of both sides,  $|\phi_2(t) - \phi_1(t)| \leq \int_0^{|t|} |[f(s, \phi_1(s)) - f(s, 0)]| ds$ . Based on the results in Problems 16 and 17,  $|\phi_2(t) - \phi_1(t)| \leq \int_0^{|t|} K |\phi_1(s) - 0| ds \leq KM \int_0^{|t|} |s| ds$ . Evaluating the last integral, we obtain  $|\phi_2(t) - \phi_1(t)| \leq MK|t|^2/2$ .

(c). Suppose that

$$|\phi_i(t) - \phi_{i-1}(t)| \leq \frac{MK^{i-1}|t|^i}{i!}$$

for some  $i \geq 1$ . By definition,  $\phi_{i+1}(t) - \phi_i(t) = \int_0^t [f(t, \phi_i(s)) - f(s, \phi_{i-1}(s))] ds$ . It follows that

$$\begin{aligned} |\phi_{i+1}(t) - \phi_i(t)| &\leq \int_0^{|t|} |f(s, \phi_i(s)) - f(s, \phi_{i-1}(s))| ds \\ &\leq \int_0^{|t|} K |\phi_i(s) - \phi_{i-1}(s)| ds \\ &\leq \int_0^{|t|} K \frac{MK^{i-1}|s|^i}{i!} ds \\ &= \frac{MK^i |t|^{i+1}}{(i+1)!} \leq \frac{MK^i h^{i+1}}{(i+1)!}. \end{aligned}$$

Hence, by mathematical induction, the assertion is true.

18(a). Use the triangle inequality,  $|a + b| \leq |a| + |b|$ .

(b). For  $|t| \leq h$ ,  $|\phi_1(t)| \leq Mh$ , and  $|\phi_n(t) - \phi_{n-1}(t)| \leq MK^{n-1}h^n/(n!)$ . Hence

$$\begin{aligned} |\phi_n(t)| &\leq M \sum_{i=1}^n \frac{K^{i-1}h^i}{i!} \\ &= \frac{M}{K} \sum_{i=1}^n \frac{(Kh)^i}{i!}. \end{aligned}$$

(c). The sequence of partial sums in (b) converges to  $\frac{M}{K}(e^{Kh} - 1)$ . By the *comparison test*, the sums in (a) also converge. Furthermore, the sequence  $|\phi_n(t)|$  is *bounded*, and hence has a convergent subsequence. Finally, since individual terms of the series must tend to zero,  $|\phi_n(t) - \phi_{n-1}(t)| \rightarrow 0$ , and it follows that the sequence  $|\phi_n(t)|$  is convergent.

19(a). Let  $\phi(t) = \int_0^t f(s, \phi(s))ds$  and  $\psi(t) = \int_0^t f(s, \psi(s))ds$ . Then by *linearity of the integral*,  $\phi(t) - \psi(t) = \int_0^t [f(s, \phi(s)) - f(s, \psi(s))]ds$ .

(b). It follows that  $|\phi(t) - \psi(t)| \leq \int_0^t |f(s, \phi(s)) - f(s, \psi(s))|ds$ .

(c). We know that  $f$  satisfies a Lipschitz condition,

$$|f(t, y_1) - f(t, y_2)| \leq K |y_1 - y_2|,$$

based on  $|\partial f / \partial y| \leq K$  in  $D$ . Therefore,

$$\begin{aligned} |\phi(t) - \psi(t)| &\leq \int_0^t |f(s, \phi(s)) - f(s, \psi(s))|ds \\ &\leq \int_0^t K |\phi(s) - \psi(s)|ds. \end{aligned}$$

**Section 2.9**

1. Writing the equation for each  $n \geq 0$ ,  $y_1 = -0.9 y_0$ ,  $y_2 = -0.9 y_1$ ,  $y_3 = -0.9 y_2$  and so on, it is apparent that  $y_n = (-0.9)^n y_0$ . The terms constitute an *alternating series*, which converge to *zero*, regardless of  $y_0$ .

3. Write the equation for each  $n \geq 0$ ,  $y_1 = \sqrt{3} y_0$ ,  $y_2 = \sqrt{4/2} y_1$ ,  $y_3 = \sqrt{5/3} y_2, \dots$ . Upon substitution, we find that  $y_2 = \sqrt{(4 \cdot 3)/2} y_1$ ,  $y_3 = \sqrt{(5 \cdot 4 \cdot 3)/(3 \cdot 2)} y_0, \dots$ . It can be proved by mathematical induction, that

$$\begin{aligned} y_n &= \frac{1}{\sqrt{2}} \sqrt{\frac{(n+2)!}{n!}} y_0 \\ &= \frac{1}{\sqrt{2}} \sqrt{(n+1)(n+2)} y_0. \end{aligned}$$

This sequence is *divergent*, except for  $y_0 = 0$ .

4. Writing the equation for each  $n \geq 0$ ,  $y_1 = -y_0$ ,  $y_2 = y_1$ ,  $y_3 = -y_2$ ,  $y_4 = y_3$ , and so on, it can be shown that

$$y_n = \begin{cases} y_0 & , \text{ for } n = 4k \text{ or } n = 4k - 1 \\ -y_0 & , \text{ for } n = 4k - 2 \text{ or } n = 4k - 3 \end{cases}$$

The sequence is convergent *only* for  $y_0 = 0$ .

6. Writing the equation for each  $n \geq 0$ ,

$$\begin{aligned} y_1 &= 0.5 y_0 + 6 \\ y_2 &= 0.5 y_1 + 6 = 0.5(0.5 y_0 + 6) + 6 = (0.5)^2 y_0 + 6 + (0.5)6 \\ y_3 &= 0.5 y_2 + 6 = 0.5(0.5 y_1 + 6) + 6 = (0.5)^3 y_0 + 6[1 + (0.5) + (0.5)^2] \\ &\vdots \\ y_n &= (0.5)^n y_0 + 12[1 - (0.5)^n] \end{aligned}$$

which can be verified by mathematical induction. The sequence is convergent for all  $y_0$ , and in fact  $y_n \rightarrow 12$ .

7. Let  $y_n$  be the balance at the end of the  $n$ -th day. Then  $y_{n+1} = (1 + r/365) y_n$ . The solution of this difference equation is  $y_n = (1 + r/365)^n y_0$ , in which  $y_0$  is the initial balance. At the end of *one year*, the balance is  $y_{365} = (1 + r/365)^{365} y_0$ . Given that  $r = .07$ ,  $y_{365} = (1 + r/365)^{365} y_0 = 1.0725 y_0$ . Hence the effective annual yield is  $(1.0725 y_0 - y_0)/y_0 = 7.25\%$ .

8. Let  $y_n$  be the balance at the end of the  $n$ -th month. Then  $y_{n+1} = (1 + r/12) y_n + 25$ . As in the previous solutions, we have

$$y_n = \rho^n \left[ y_0 - \frac{25}{1 - \rho} \right] + \frac{25}{1 - \rho},$$

in which  $\rho = (1 + r/12)$ . Here  $r$  is the annual interest rate, given as 8%. Therefore  $y_{36} = (1.0066)^{36} \left[ 1000 + \frac{(12)25}{r} \right] - \frac{(12)25}{r} = 2,283.63$  dollars.

9. Let  $y_n$  be the balance due at the end of the  $n$ -th month. The appropriate difference equation is  $y_{n+1} = (1 + r/12) y_n - P$ . Here  $r$  is the annual interest rate and  $P$  is the monthly payment. The solution, in terms of the amount borrowed, is given by

$$y_n = \rho^n \left[ y_0 + \frac{P}{1 - \rho} \right] - \frac{P}{1 - \rho},$$

in which  $\rho = (1 + r/12)$  and  $y_0 = 8,000$ . To figure out the monthly payment,  $P$ , we require that  $y_{36} = 0$ . That is,

$$\rho^{36} \left[ y_0 + \frac{P}{1 - \rho} \right] = \frac{P}{1 - \rho}.$$

After the specified amounts are substituted, we find the  $P = \$258.14$ .

11. Let  $y_n$  be the balance due at the end of the  $n$ -th month. The appropriate difference equation is  $y_{n+1} = (1 + r/12) y_n - P$ , in which  $r = .09$  and  $P$  is the monthly payment. The initial value of the mortgage is  $y_0 = 100,000$  dollars. Then the balance due at the end of the  $n$ -th month is

$$y_n = \rho^n \left[ y_0 + \frac{P}{1 - \rho} \right] - \frac{P}{1 - \rho}.$$

where  $\rho = (1 + r/12)$ . In terms of the specified values,

$$y_n = (0.0075)^n \left[ 10^5 - \frac{12P}{r} \right] + \frac{12P}{r}.$$

Setting  $n = 30(12) = 360$ , and  $y_{360} = 0$ , we find that  $P = 804.62$  dollars. For the monthly payment corresponding to a 20 year mortgage, set  $n = 240$  and  $y_{240} = 0$ .

12. Let  $y_n$  be the balance due at the end of the  $n$ -th month, with  $y_0$  the initial value of the mortgage. The appropriate difference equation is  $y_{n+1} = (1 + r/12) y_n - P$ , in which  $r = 0.1$  and  $P = 900$  dollars is the *maximum* monthly payment. Given that the life of the mortgage is 20 years, we require that  $y_{240} = 0$ . The balance due at the end of the  $n$ -th month is

$$y_n = \rho^n \left[ y_0 + \frac{P}{1 - \rho} \right] - \frac{P}{1 - \rho}.$$

In terms of the specified values for the parameters, the solution of

$$(.00833)^{240} \left[ y_0 - \frac{12(1000)}{0.1} \right] = - \frac{12(1000)}{0.1}$$

is  $y_0 = 103,624.62$  dollars.

15.

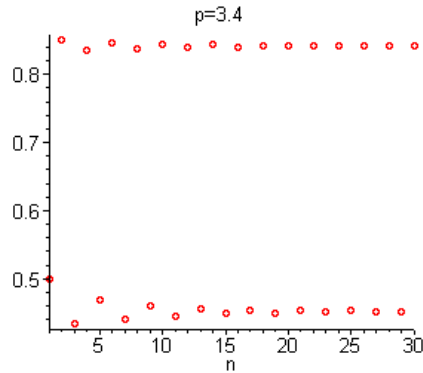
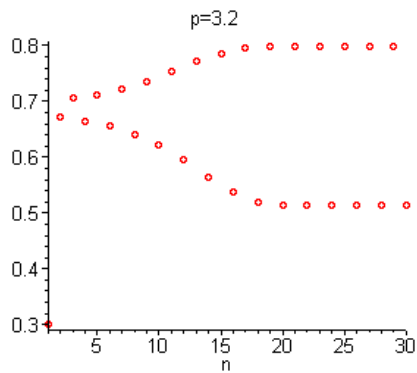
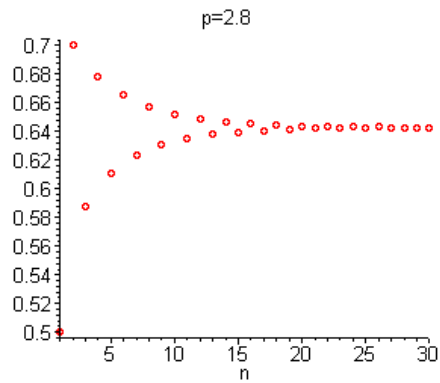
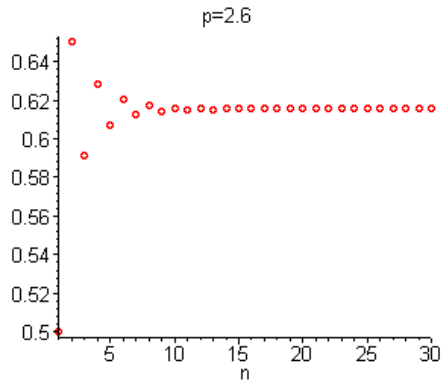

16. For example, take  $\rho = 3.5$  and  $u_0 = 1.1$  :

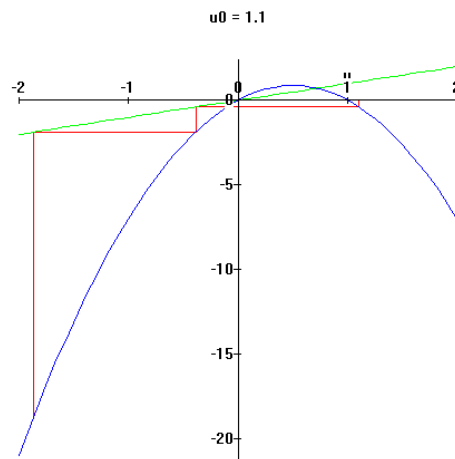

19(a).  $\delta_2 = (\rho_2 - \rho_1)/(\rho_3 - \rho_2) = (3.449 - 3)/(3.544 - 3.449) = 4.7263$ .

(b).  $\% \text{ diff} = \frac{|\delta - \delta_2|}{\delta} \times 100 = \frac{|4.6692 - 4.7363|}{4.6692} \times 100 \approx 1.22 \%$ .

(c). Assuming  $(\rho_3 - \rho_2)/(\rho_4 - \rho_3) = \delta$ ,  $\rho_4 \approx 3.5643$

(d). A period 16 solutions appears near  $\rho \approx 3.565$ .

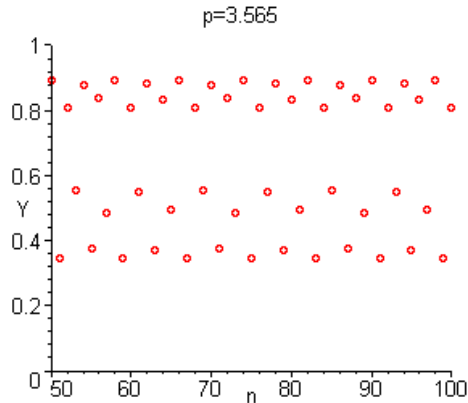

(e). Note that  $(\rho_{n+1} - \rho_n) = \delta_n^{-1}(\rho_n - \rho_{n-1})$ . With the assumption that  $\delta_n = \delta$ , we have  $(\rho_{n+1} - \rho_n) = \delta^{-1}(\rho_n - \rho_{n-1})$ , which is of the form  $y_{n+1} = \alpha y_n$ ,  $n \geq 3$ . It follows that  $(\rho_k - \rho_{k-1}) = \delta^{3-k}(\rho_3 - \rho_2)$  for  $k \geq 4$ . Then

$$\begin{aligned} \rho_n &= \rho_1 + (\rho_2 - \rho_1) + (\rho_3 - \rho_2) + (\rho_4 - \rho_3) + \dots + (\rho_n - \rho_{n-1}) \\ &= \rho_1 + (\rho_2 - \rho_1) + (\rho_3 - \rho_2)[1 + \delta^{-1} + \delta^{-2} + \dots + \delta^{3-n}] \\ &= \rho_1 + (\rho_2 - \rho_1) + (\rho_3 - \rho_2) \left[ \frac{1 - \delta^{4-n}}{1 - \delta^{-1}} \right]. \end{aligned}$$

Hence  $\lim_{n \rightarrow \infty} \rho_n = \rho_2 + (\rho_3 - \rho_2) \left[ \frac{\delta}{\delta - 1} \right]$ . Substitution of the appropriate values yields

$$\lim_{n \rightarrow \infty} \rho_n = 3.5699$$

**Miscellaneous Problems**

1. Linear  $[y = c/x^2 + x^3/5]$ .
2. Homogeneous  $[\arctan(y/x) - \ln\sqrt{x^2 + y^2} = c]$ .
3. Exact  $[x^2 + xy - 3y - y^3 = 0]$ .
4. Linear in  $x(y)$   $[x = ce^y + ye^y]$ .
5. Exact  $[x^2y + xy^2 + x = c]$ .
6. Linear  $[y = x^{-1}(1 - e^{1-x})]$ .
7. Let  $u = x^2$   $[x^2 + y^2 + 1 = ce^{y^2}]$ .
8. Linear  $[y = (4 + \cos 2 - \cos x)/x^2]$ .
9. Exact  $[x^2y + x + y^2 = c]$ .
10.  $\mu = \mu(x)$   $[y^2/x^3 + y/x^2 = c]$ .
11. Exact  $[x^3/3 + xy + e^y = c]$ .
12. Linear  $[y = ce^{-x} + e^{-x}\ln(1 + e^x)]$ .
13. Homogeneous  $[2\sqrt{y/x} - \ln|x| = c]$ .
14. Exact/Homogeneous  $[x^2 + 2xy + 2y^2 = 34]$ .
15. Separable  $[y = c/\cosh^2(x/2)]$ .
16. Homogeneous  $[(2/\sqrt{3})\arctan[(2y - x)/\sqrt{3}x] - \ln|x| = c]$ .
17. Linear  $[y = ce^{3x} - e^{2x}]$ .
18. Linear/Homogeneous  $[y = cx^{-2} - x]$ .
19.  $\mu = \mu(x)$   $[3y - 2xy^3 - 10x = 0]$ .
20. Separable  $[e^x + e^{-y} = c]$ .
21. Homogeneous  $[e^{-y/x} + \ln|x| = c]$ .
22. Separable  $[y^3 + 3y - x^3 + 3x = 2]$ .
23. Bernoulli  $[1/y = -x \int x^{-2}e^{2x} dx + cx]$ .
24. Separable  $[\sin^2 x \sin y = c]$ .
25. Exact  $[x^2/y + \arctan(y/x) = c]$ .
26.  $\mu = \mu(x)$   $[x^2 + 2x^2y - y^2 = c]$ .
27.  $\mu = \mu(x)$   $[\sin x \cos 2y - \frac{1}{2}\sin^2 x = c]$ .
28. Exact  $[2xy + xy^3 - x^3 = c]$ .
29. Homogeneous  $[\arcsin(y/x) - \ln|x| = c]$ .
30. Linear in  $x(y)$   $[xy^2 - \ln|y| = 0]$ .
31. Separable  $[x + \ln|x| + x^{-1} + y - 2\ln|y| = c]$ .
32.  $\mu = \mu(y)$   $[x^3y^2 + xy^3 = -4]$ .

## Chapter Three

### Section 3.1

1. Let  $y = e^{rt}$ , so that  $y' = r e^{rt}$  and  $y'' = r e^{rt}$ . Direct substitution into the differential equation yields  $(r^2 + 2r - 3)e^{rt} = 0$ . Canceling the exponential, the characteristic equation is  $r^2 + 2r - 3 = 0$ . The roots of the equation are  $r = -3, 1$ . Hence the general solution is  $y = c_1 e^t + c_2 e^{-3t}$ .
2. Let  $y = e^{rt}$ . Substitution of the assumed solution results in the characteristic equation  $r^2 + 3r + 2 = 0$ . The roots of the equation are  $r = -2, -1$ . Hence the general solution is  $y = c_1 e^{-t} + c_2 e^{-2t}$ .
4. Substitution of the assumed solution  $y = e^{rt}$  results in the characteristic equation  $2r^2 - 3r + 1 = 0$ . The roots of the equation are  $r = 1/2, 1$ . Hence the general solution is  $y = c_1 e^{t/2} + c_2 e^t$ .
6. The characteristic equation is  $4r^2 - 9 = 0$ , with roots  $r = \pm 3/2$ . Therefore the general solution is  $y = c_1 e^{-3t/2} + c_2 e^{3t/2}$ .
8. The characteristic equation is  $r^2 - 2r - 2 = 0$ , with roots  $r = 1 \pm \sqrt{3}$ . Hence the general solution is  $y = c_1 \exp(1 - \sqrt{3})t + c_2 \exp(1 + \sqrt{3})t$ .
9. Substitution of the assumed solution  $y = e^{rt}$  results in the characteristic equation  $r^2 + r - 2 = 0$ . The roots of the equation are  $r = -2, 1$ . Hence the general solution is  $y = c_1 e^{-2t} + c_2 e^t$ . Its derivative is  $y' = -2c_1 e^{-2t} + c_2 e^t$ . Based on the first condition,  $y(0) = 1$ , we require that  $c_1 + c_2 = 1$ . In order to satisfy  $y'(0) = 1$ , we find that  $-2c_1 + c_2 = 1$ . Solving for the constants,  $c_1 = 0$  and  $c_2 = 1$ . Hence the specific solution is  $y(t) = e^t$ .
11. Substitution of the assumed solution  $y = e^{rt}$  results in the characteristic equation  $6r^2 - 5r + 1 = 0$ . The roots of the equation are  $r = 1/3, 1/2$ . Hence the general solution is  $y = c_1 e^{t/3} + c_2 e^{t/2}$ . Its derivative is  $y' = c_1 e^{t/3}/3 + c_2 e^{t/2}/2$ . Based on the first condition,  $y(0) = 1$ , we require that  $c_1 + c_2 = 4$ . In order to satisfy the condition  $y'(0) = 1$ , we find that  $c_1/3 + c_2/2 = 0$ . Solving for the constants,  $c_1 = 12$  and  $c_2 = -8$ . Hence the specific solution is  $y(t) = 12 e^{t/3} - 8 e^{t/2}$ .
12. The characteristic equation is  $r^2 + 3r = 0$ , with roots  $r = -3, 0$ . Therefore the general solution is  $y = c_1 + c_2 e^{-3t}$ , with derivative  $y' = -3c_2 e^{-3t}$ . In order to satisfy the initial conditions, we find that  $c_1 + c_2 = -2$ , and  $-3c_2 = 3$ . Hence the specific solution is  $y(t) = -1 - e^{-3t}$ .
13. The characteristic equation is  $r^2 + 5r + 3 = 0$ , with roots



$$r_{1,2} = -\frac{5}{2} \pm \frac{\sqrt{13}}{2}.$$

The general solution is  $y = c_1 \exp\left(-5 - \sqrt{13}\right)t/2 + c_2 \exp\left(-5 + \sqrt{13}\right)t/2$ , with derivative

$$y' = \frac{-5 - \sqrt{13}}{2} c_1 \exp\left(-5 - \sqrt{13}\right)t/2 + \frac{-5 + \sqrt{13}}{2} c_2 \exp\left(-5 + \sqrt{13}\right)t/2.$$

In order to satisfy the initial conditions, we require that  $c_1 + c_2 = 1$ , and  $\frac{-5 - \sqrt{13}}{2} c_1 + \frac{-5 + \sqrt{13}}{2} c_2 = 0$ . Solving for the coefficients,  $c_1 = \left(1 - 5/\sqrt{13}\right)/2$  and  $c_2 = \left(1 + 5/\sqrt{13}\right)/2$ .

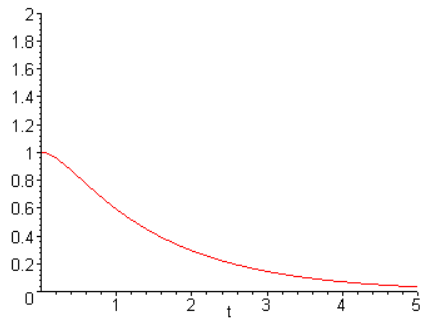

14. The characteristic equation is  $2r^2 + r - 4 = 0$ , with roots

$$r_{1,2} = -\frac{1}{4} \pm \frac{\sqrt{33}}{4}.$$

The general solution is  $y = c_1 \exp\left(-1 - \sqrt{33}\right)t/4 + c_2 \exp\left(-1 + \sqrt{33}\right)t/4$ , with derivative

$$y' = \frac{-1 - \sqrt{33}}{4} c_1 \exp\left(-1 - \sqrt{33}\right)t/4 + \frac{-1 + \sqrt{33}}{4} c_2 \exp\left(-1 + \sqrt{33}\right)t/4.$$

In order to satisfy the initial conditions, we require that  $c_1 + c_2 = 0$ , and  $\frac{-1 - \sqrt{33}}{4} c_1 + \frac{-1 + \sqrt{33}}{4} c_2 = 1$ . Solving for the coefficients,  $c_1 = -2/\sqrt{33}$  and  $c_2 = 2/\sqrt{33}$ . The specific solution is

$$y(t) = -2 \left[ \exp\left(-1 - \sqrt{33}\right)t/4 - \exp\left(-1 + \sqrt{33}\right)t/4 \right] / \sqrt{33}.$$

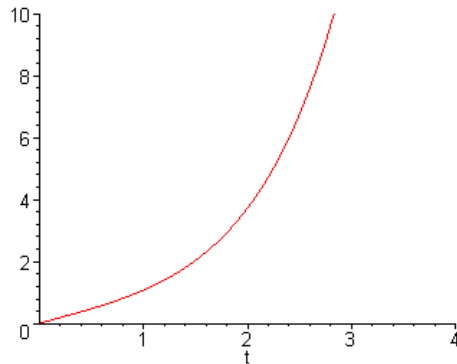

16. The characteristic equation is  $4r^2 - 1 = 0$ , with roots  $r = \pm 1/2$ . Therefore the general solution is  $y = c_1 e^{-t/2} + c_2 e^{t/2}$ . Since the initial conditions are specified at  $t = -2$ , it is more convenient to write  $y = d_1 e^{-(t+2)/2} + d_2 e^{(t+2)/2}$ . The derivative is given by  $y' = -[d_1 e^{-(t+2)/2}]/2 + [d_2 e^{(t+2)/2}]/2$ . In order to satisfy the initial conditions, we find that  $d_1 + d_2 = 1$ , and  $-d_1/2 + d_2/2 = -1$ . Solving for the coefficients,  $d_1 = 3/2$ , and  $d_2 = -1/2$ . The specific solution is

$$\begin{aligned} y(t) &= \frac{3}{2} e^{-(t+2)/2} - \frac{1}{2} e^{(t+2)/2} \\ &= \frac{3}{2e} e^{-t/2} - \frac{e}{2} e^{t/2}. \end{aligned}$$

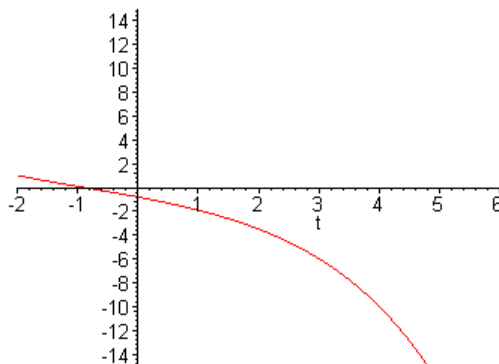

18. An algebraic equation with roots  $-2$  and  $-1/2$  is  $2r^2 + 5r + 2 = 0$ . This is the characteristic equation for the ODE  $2y'' + 5y' + 2y = 0$ .

20. The characteristic equation is  $2r^2 - 3r + 1 = 0$ , with roots  $r = 1/2, 1$ . Therefore the general solution is  $y = c_1 e^{t/2} + c_2 e^t$ , with derivative  $y' = c_1 e^{t/2}/2 + c_2 e^t$ . In order to satisfy the initial conditions, we require  $c_1 + c_2 = 2$  and  $c_1/2 + c_2 = 1/2$ . Solving for the coefficients,  $c_1 = 3$ , and  $c_2 = -1$ . The specific solution is  $y(t) = 3e^{t/2} - e^t$ . To find the *stationary point*, set  $y' = 3e^{t/2}/2 - e^t = 0$ . There is a unique solution, with  $t_1 = \ln(9/4)$ . The maximum value is then  $y(t_1) = 9/4$ . To find

the  $x$ -intercept, solve the equation  $3e^{t/2} - e^t = 0$ . The solution is readily found to be  $t_2 = \ln 9 \approx 2.1972$ .

22. The characteristic equation is  $4r^2 - 1 = 0$ , with roots  $r = \pm 1/2$ . Hence the general solution is  $y = c_1 e^{-t/2} + c_2 e^{t/2}$ , with derivative  $y' = -c_1 e^{-t/2}/2 + c_2 e^{t/2}/2$ . Invoking the initial conditions, we require that  $c_1 + c_2 = 2$  and  $-c_1 + c_2 = \beta$ . The specific solution is  $y(t) = (1 - \beta)e^{-t/2} + (1 + \beta)e^{t/2}$ . Based on the form of the solution, it is evident that as  $t \rightarrow \infty$ ,  $y(t) \rightarrow 0$  as long as  $\beta = -1$ .

23. The characteristic equation is  $r^2 - (2\alpha - 1)r + \alpha(\alpha - 1) = 0$ . Examining the coefficients, the roots are  $r = \alpha, \alpha - 1$ . Hence the general solution of the differential equation is  $y(t) = c_1 e^{\alpha t} + c_2 e^{(\alpha-1)t}$ . Assuming  $\alpha \in \mathbb{R}$ , all solutions will tend to zero as long as  $\alpha < 0$ . On the other hand, all solutions will become unbounded as long as  $\alpha - 1 > 0$ , that is,  $\alpha > 1$ .

25.  $y(t) = 2e^{t/2}/5 + 3e^{-2t}/5$ .

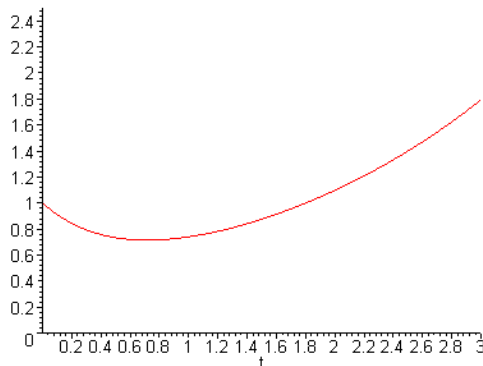

The minimum occurs at  $(t_0, y_0) = (0.7167, 0.7155)$ .

26(a). The characteristic roots are  $r = -3, -2$ . The solution of the initial value problem is  $y(t) = (6 + \beta)e^{-2t} - (4 + \beta)e^{-3t}$ .

(b). The maximum point has coordinates  $t_0 = \ln \left[ \frac{3(4+\beta)}{2(6+\beta)} \right]$ ,  $y_0 = \frac{4(6+\beta)^3}{27(4+\beta)^2}$ .

(c).  $y_0 = \frac{4(6+\beta)^3}{27(4+\beta)^2} \geq 4$ , as long as  $\beta \geq 6 + 6\sqrt{3}$ .

(d).  $\lim_{\beta \rightarrow \infty} t_0 = \ln \frac{3}{2}$ .  $\lim_{\beta \rightarrow \infty} y_0 = \infty$ .

29. Set  $v = y'$  and  $v' = y''$ . Substitution into the ODE results in the first order equation  $t v' + v = 1$ . The equation is *linear*, and can be written as  $(t v)' = 1$ . Hence the general solution is  $v = 1 + c_1/t$ . Hence  $y' = 1 + c_1/t$ , and  $y = t + c_1 \ln t + c_2$ .

31. Setting  $v = y'$  and  $v' = y''$ , the transformed equation is  $2t^2 v' + v^3 = 2t v$ . This

is a *Bernoulli* equation, with  $n = 3$ . Let  $w = v^{-2}$ . Substitution of the new dependent variable yields  $-t^2 w' + 1 = 2t w$ , or  $t^2 w' + 2t w = 1$ . Integrating, we find that  $w = (t + c_1)/t^2$ . Hence  $v = \pm t/\sqrt{t + c_1}$ , that is,  $y' = \pm t/\sqrt{t + c_1}$ . Integrating one more time results in  $y(t) = \pm \frac{2}{3}(t - 2c_1)\sqrt{t + c_1} + c_2$ . (Note that  $v = 0$  is also a solution of the transformed equation).

32. Setting  $v = y'$  and  $v' = y''$ , the transformed equation is  $v' + v = e^{-t}$ . This ODE is *linear*, with integrating factor  $\mu(t) = e^t$ . Hence  $v = y' = (t + c_1)e^{-t}$ . Integrating, we obtain  $y(t) = -(t + c_1)e^{-t} + c_2$ .

33. Set  $v = y'$  and  $v' = y''$ . The resulting equation is  $t^2 v' = v^2$ . This equation is *separable*, with solution  $v = y' = t/(1 + c_1 t)$ . Integrating, the general solution is

$$y(t) = t/c_1 - c_1^{-2} \ln|1 + c_1 t| + c_2,$$

as long as  $c_1 \neq 0$ . For  $c_1 = 0$ , the solution is  $y(t) = t^2/2 + c_2$ . Note that  $v = 0$  is also a solution of the transformed equation.

35. Let  $y' = v$  and  $y'' = v dv/dy$ . Then  $v dv/dy + y = 0$  is the transformed equation for  $v = v(y)$ . This equation is *separable*, with  $v dv = -y dy$ . The solution is given by  $v^2 = -y^2 + c_1$ . Substituting for  $v$ , we find that  $y' = \pm \sqrt{c_1 - y^2}$ . This equation is *also* separable, with solution  $\arcsin(y/\sqrt{c_1}) = \pm t + c_2$ , or  $y(t) = d_1 \sin(t + d_2)$ .

36. Let  $y' = v$  and  $y'' = v dv/dy$ . It follows that  $v dv/dy + yv^3 = 0$  is the differential equation for  $v = v(y)$ . This equation is *separable*, with  $v^{-2} dv = -y dy$ . The solution is given by  $v = [y^2/2 + c_1]^{-1}$ . Substituting for  $v$ , we find that  $y' = [y^2/2 + c_1]^{-1}$ . This equation is *also* separable, with  $(y^2/2 + c_1) dy = dt$ . The solution is defined *implicitly* by  $y^3/6 + c_1 y + c_2 = t$ .

38. Setting  $y' = v$  and  $y'' = v dv/dy$ , the transformed equation is  $y v dv/dy - v^3 = 0$ . This equation is *separable*, with  $v^{-2} dv = dy/y$ . The solution is  $v(y) = [c_1 - \ln|y|]^{-1}$ . Substituting for  $v$ , we obtain a *separable* equation,  $(c_1 - \ln|y|) dy = dx$ . The solution is given *implicitly* by  $c_2 y - y \ln|y| + c_3 = t$ .

39. Let  $y' = v$  and  $y'' = v dv/dy$ . It follows that  $v dv/dy + v^2 = 2e^{-y}$  is the equation for  $v = v(y)$ . Inspection of the left hand side suggests a substitution  $w = v^2$ . The resulting equation is  $dw/dy + 2w = 4e^{-y}$ . This equation is *linear*, with integrating factor  $\mu = e^{2y}$ .

We obtain  $d(e^{2y} w)/dy = 4e^y$ , which upon integration yields  $w(y) = 4e^{-y} + c_1 e^{-2y}$ . Converting back to the original dependent variable,  $y' = \pm e^{-y} \sqrt{4e^y + c_1}$ . Separating variables,  $e^y (4e^y + c_1)^{-1/2} dy = \pm dt$ . Integration yields  $\sqrt{4e^y + c_1} = \pm 2t + c_2$ .

41. Setting  $y' = v$  and  $y'' = v dv/dy$ , the transformed equation is  $v dv/dy - 3y^2 = 0$ .

This equation is *separable*, with  $vdv = 3y^2dy$ . The solution is  $y' = v = \sqrt{2y^3 + c_1}$ . The *positive* root is chosen based on the initial conditions. Furthermore, when  $t = 0$ ,  $y = 2$ , and  $y' = v = 4$ . The initial conditions require that  $c_1 = 0$ . It follows that  $y' = \sqrt{2y^3}$ . Separating variables and integrating,  $1/\sqrt{y} = -t/\sqrt{2} + c_2$ . Hence the solution is  $y(t) = 2/(1 - t)^2$ .

42. Setting  $v = y'$  and  $v' = y''$ , the transformed equation is  $(1 + t^2)v' + 2tv = -3t^{-2}$ . Rewrite the equation as  $v' + 2tv/(1 + t^2) = -3t^{-2}/(1 + t^2)$ . This equation is *linear*, with integrating factor  $\mu = 1 + t^2$ . Hence we have

$$[(1 + t^2)v]' = -3t^{-2}.$$

Integrating both sides,  $v = 3t^{-1}/(1 + t^2) + c_1/(1 + t^2)$ . Invoking the initial condition  $v(1) = -1$ , we require that  $c_1 = -5$ . Hence  $y' = (3 - 5t)/(t + t^3)$ . Integrating, we obtain  $y(t) = \frac{3}{2}\ln[t^2/(1 + t^2)] - 5\arctan(t) + c_2$ . Based on the initial condition  $y(1) = 2$ , we find that  $c_2 = \frac{3}{2}\ln 2 + \frac{5}{4}\pi + 2$ .

## Section 3.2

1.

$$W(e^{2t}, e^{-3t/2}) = \begin{vmatrix} e^{2t} & e^{-3t/2} \\ 2e^{2t} & -\frac{3}{2}e^{-3t/2} \end{vmatrix} = -\frac{7}{2}e^{t/2}.$$

3.

$$W(e^{-2t}, te^{-2t}) = \begin{vmatrix} e^{-2t} & te^{-2t} \\ -2e^{-2t} & (1-2t)e^{-2t} \end{vmatrix} = e^{-4t}.$$

5.

$$W(e^t \sin t, e^t \cos t) = \begin{vmatrix} e^t \sin t & e^t \cos t \\ e^t(\sin t + \cos t) & e^t(\cos t - \sin t) \end{vmatrix} = -e^{2t}.$$

6.

$$W(\cos^2 \theta, 1 + \cos 2\theta) = \begin{vmatrix} \cos^2 \theta & 1 + \cos 2\theta \\ -2 \sin \theta \cos \theta & -2 \sin 2\theta \end{vmatrix} = 0.$$

7. Write the equation as  $y'' + (3/t)y' = 1$ .  $p(t) = 3/t$  is continuous for all  $t > 0$ . Since  $t_0 > 0$ , the IVP has a unique solution for all  $t > 0$ .

9. Write the equation as  $y'' + \frac{3}{t-4}y' + \frac{4}{t(t-4)}y = \frac{2}{t(t-4)}$ . The coefficients are not continuous at  $t = 0$  and  $t = 4$ . Since  $t_0 \in (0, 4)$ , the largest interval is  $0 < t < 4$ .

10. The coefficient  $3 \ln|t|$  is discontinuous at  $t = 0$ . Since  $t_0 > 0$ , the largest interval of existence is  $0 < t < \infty$ .

11. Write the equation as  $y'' + \frac{x}{x-3}y' + \frac{\ln|x|}{x-3}y = 0$ . The coefficients are discontinuous at  $x = 0$  and  $x = 3$ . Since  $x_0 \in (0, 3)$ , the largest interval is  $0 < x < 3$ .

13.  $y_1'' = 2$ . We see that  $t^2(2) - 2(t^2) = 0$ .  $y_2'' = 2t^{-3}$ , with  $t^2(y_2'') - 2(y_2) = 0$ . Let  $y_3 = c_1 t^2 + c_2 t^{-1}$ , then  $y_3'' = 2c_1 + 2c_2 t^{-3}$ . It is evident that  $y_3$  is also a solution.

16. No. Substituting  $y = \sin(t^2)$  into the differential equation,

$$-4t^2 \sin(t^2) + 2 \cos(t^2) + 2t \cos(t^2)p(t) + \sin(t^2)q(t) = 0.$$

For the equation to be valid, we must have  $p(t) = -1/t$ , which is *not* continuous, or even defined, at  $t = 0$ .

17.  $W(e^{2t}, g(t)) = e^{2t}g'(t) - 2e^{2t}g(t) = 3e^{4t}$ . Dividing both sides by  $e^{2t}$ , we find that  $g$  must satisfy the ODE  $g' - 2g = 3e^{2t}$ . Hence  $g(t) = 3te^{2t} + ce^{2t}$ .

19.  $W(f, g) = fg' - f'g$ . Also,  $W(u, v) = W(2f - g, f + 2g)$ . Upon evaluation,  $W(u, v) = 5fg' - 5f'g = 5W(f, g)$ .

20.  $W(f, g) = fg' - f'g = t \cos t - \sin t$ , and  $W(u, v) = -4fg' + 4f'g$ . Hence  $W(u, v) = -4t \cos t + 4 \sin t$ .

22. The general solution is  $y = c_1e^{-3t} + c_2e^{-t}$ .  $W(e^{-3t}, e^{-t}) = 2e^{-4t}$ , and hence the exponentials form a *fundamental set* of solutions. On the other hand, the *fundamental solutions* must also satisfy the conditions  $y_1(1) = 1, y_1'(1) = 0; y_2(1) = 0, y_2'(1) = 1$ . For  $y_1$ , the initial conditions require  $c_1 + c_2 = e, -3c_1 - c_2 = 0$ . The coefficients are  $c_1 = -e^3/2, c_2 = 3e/2$ . For the solution,  $y_2$ , the initial conditions require  $c_1 + c_2 = 0, -3c_1 - c_2 = e$ . The coefficients are  $c_1 = -e^3/2, c_2 = e/2$ . Hence the fundamental solutions are  $\{y_1 = -\frac{1}{2}e^{-3(t-1)} + \frac{3}{2}e^{-(t-1)}, y_2 = -\frac{1}{2}e^{-3(t-1)} + \frac{1}{2}e^{-(t-1)}\}$ .

23. Yes.  $y_1'' = -4 \cos 2t; y_2'' = -4 \sin 2t$ .  $W(\cos 2t, \sin 2t) = 2$ .

24. Clearly,  $y_1 = e^t$  is a solution.  $y_2' = (1+t)e^t, y_2'' = (2+t)e^t$ . Substitution into the ODE results in  $(2+t)e^t - 2(1+t)e^t + te^t = 0$ . Furthermore,  $W(e^t, te^t) = e^{2t}$ . Hence the solutions form a fundamental set of solutions.

26. Clearly,  $y_1 = x$  is a solution.  $y_2' = \cos x, y_2'' = -\sin x$ . Substitution into the ODE results in  $(1 - x \cot x)(-\sin x) - x(\cos x) + \sin x = 0$ .  $W(y_1, y_2) = x \cos x - \sin x$ ,

which is *nonzero* for  $0 < x < \pi$ . Hence  $\{x, \sin x\}$  is a fundamental set of solutions.

28.  $P = 1, Q = x, R = 1$ . We have  $P'' - Q' + R = 0$ . The equation is *exact*. Note that  $(y')' + (xy)' = 0$ . Hence  $y' + xy = c_1$ . This equation is *linear*, with integrating factor  $\mu = e^{x^2/2}$ . Therefore the general solution is

$$y(x) = c_1 \exp(-x^2/2) \int_{x_0}^x \exp(u^2/2) du + c_2 \exp(-x^2/2).$$

29.  $P = 1, Q = 3x^2, R = x$ . Note that  $P'' - Q' + R = -5x$ , and therefore the differential equation is *not exact*.

31.  $P = x^2, Q = x, R = -1$ . We have  $P'' - Q' + R = 0$ . The equation is *exact*. Write the equation as  $(x^2y')' - (xy)' = 0$ . Integrating, we find that  $x^2y' - xy = c$ . Divide both sides of the ODE by  $x^2$ . The resulting equation is *linear*, with integrating factor  $\mu = 1/x$ . Hence  $(y/x)' = cx^{-3}$ . The solution is  $y(t) = c_1x^{-1} + c_2x$ .

33.  $P = x^2$ ,  $Q = x$ ,  $R = x^2 - \nu^2$ . Hence the coefficients are  $2P' - Q = 3x$  and  $P'' - Q' + R = x^2 + 1 - \nu^2$ . The *adjoint* of the original differential equation is given by  $x^2\mu'' + 3x\mu' + (x^2 + 1 - \nu^2)\mu = 0$ .

35.  $P = 1$ ,  $Q = 0$ ,  $R = -x$ . Hence the coefficients are given by  $2P' - Q = 0$  and  $P'' - Q' + R = -x$ . Therefore the *adjoint* of the original equation is  $\mu'' - x\mu = 0$ .



## Section 3.3

1. Suppose that  $\alpha f(t) + \beta g(t) = 0$ , that is,  $\alpha(t^2 + 5t) + \beta(t^2 - 5t) = 0$  on some interval  $I$ . Then  $(\alpha + \beta)t^2 + 5(\alpha - \beta)t = 0, \forall t \in I$ . Since a quadratic has at most two roots, we must have  $\alpha + \beta = 0$  and  $\alpha - \beta = 0$ . The only solution is  $\alpha = \beta = 0$ . Hence the two functions are linearly *independent*.

3. Suppose that  $e^{\lambda t} \cos \mu t = A e^{\lambda t} \sin \mu t$ , for some  $A \neq 0$ , on an interval  $I$ . Since the function  $\sin \mu t \neq 0$  on some subinterval  $I_0 \subset I$ , we conclude that  $\tan \mu t = A$  on  $I_0$ . This is clearly a contradiction, hence the functions are linearly *independent*.

4. Obviously,  $f(x) = e g(x)$  for all real numbers  $x$ . Hence the functions are linearly *dependent*.

5. Here  $f(x) = 3g(x)$  for all real numbers. Hence the functions are linearly *dependent*.

8. Note that  $f(x) = g(x)$  for  $x \in [0, \infty)$ , and  $f(x) = -g(x)$  for  $x \in (-\infty, 0]$ . It follows that the functions are linearly *dependent* on  $\mathbb{R}^+$  and  $\mathbb{R}^-$ . Nevertheless, they are linearly *independent* on any open interval containing zero.

9. Since  $W(t) = t \sin^2 t$  has only *isolated* zeros,  $W(t)$  cannot identically vanish on any open interval. Hence the functions are linearly *independent*.

10. Same argument as in Prob. 9.

11. By linearity of the differential operator,  $c_1 y_1$  and  $c_2 y_2$  are also solutions.

Calculating

the Wronskian,  $W(c_1 y_1, c_2 y_2) = (c_1 y_1)(c_2 y_2)' - (c_1 y_1)'(c_2 y_2) = c_1 c_2 W(y_1, y_2)$ .

Since  $W(y_1, y_2)$  is not *identically zero*, neither is  $W(c_1 y_1, c_2 y_2)$ .

13. Direct calculation results in

$$\begin{aligned} W(a_1 y_1 + a_2 y_2, b_1 y_1 + b_2 y_2) &= a_1 b_2 W(y_1, y_2) - b_1 a_2 W(y_1, y_2) \\ &= (a_1 b_2 - a_2 b_1) W(y_1, y_2). \end{aligned}$$

Hence the combinations are also linearly independent as long as  $a_1 b_2 - a_2 b_1 \neq 0$ .

14. Let  $\alpha(\mathbf{i} + \mathbf{j}) + \beta(\mathbf{i} - \mathbf{j}) = 0\mathbf{i} + 0\mathbf{j}$ . Then  $\alpha + \beta = 0$  and  $\alpha - \beta = 0$ . The only solution is  $\alpha = \beta = 0$ . Hence the given vectors are linearly independent. Furthermore, any vector  $a_1 \mathbf{i} + a_2 \mathbf{j} = \left(\frac{a_1}{2} + \frac{a_2}{2}\right)(\mathbf{i} + \mathbf{j}) + \left(\frac{a_1}{2} - \frac{a_2}{2}\right)(\mathbf{i} - \mathbf{j})$ .

16. Writing the equation in standard form, we find that  $P(t) = \sin t / \cos t$ . Hence the Wronskian is  $W(t) = b \exp\left(-\int \frac{\sin t}{\cos t} dt\right) = b \exp(\ln|\cos t|) = b \cos t$ , in which  $b$  is some constant.

17. After writing the equation in standard form, we have  $P(x) = 1/x$ . The Wronskian is  $W(t) = c \exp\left(-\int \frac{1}{x} dx\right) = c \exp(-\ln|x|) = c/|x|$ , in which  $c$  is some constant.

18. Writing the equation in standard form, we find that  $P(x) = -2x/(1-x^2)$ . The Wronskian is  $W(t) = c \exp\left(-\int \frac{-2x}{1-x^2} dx\right) = c \exp(-\ln|1-x^2|) = c|1-x^2|^{-1}$ , in which  $c$  is some constant.

19. Rewrite the equation as  $p(t)y'' + p'(t)y' + q(t)y = 0$ . After writing the equation in standard form, we have  $P(t) = p'(t)/p(t)$ . Hence the Wronskian is

$$W(t) = c \exp\left(-\int \frac{p'(t)}{p(t)} dt\right) = c \exp(-\ln p(t)) = c/p(t).$$

21. The Wronskian associated with the solutions of the differential equation is given by  $W(t) = c \exp\left(-\int \frac{-2}{t^2} dt\right) = c \exp(-2/t)$ . Since  $W(2) = 3$ , it follows that for the hypothesized set of solutions,  $c = 3e$ . Hence  $W(4) = 3\sqrt{e}$ .

22. For the given differential equation, the Wronskian satisfies the first order differential equation  $W' + p(t)W = 0$ . Given that  $W$  is *constant*, it is necessary that  $p(t) \equiv 0$ .

23. Direct calculation shows that

$$\begin{aligned} W(fg, fh) &= (fg)(fh)' - (fg)'(fh) \\ &= (fg)(f'h + fh') - (f'g + fg')(fh) \\ &= f^2 W(g, h). \end{aligned}$$

25. Since  $y_1$  and  $y_2$  are solutions, they are differentiable. The hypothesis can thus be restated as  $y_1'(t_0) = y_2'(t_0) = 0$  at some point  $t_0$  in the interval of definition. This implies that  $W(y_1, y_2)(t_0) = 0$ . But  $W(y_1, y_2)(t_0) = c \exp\left(-\int p(t) dt\right)$ , which *cannot* be equal to zero, unless  $c = 0$ . Hence  $W(y_1, y_2) \equiv 0$ , which is ruled out for a fundamental set of solutions.

## Section 3.4

2.  $\exp(2 - 3i) = e^2 e^{-3i} = e^2 (\cos 3 - i \sin 3)$ .

3.  $e^{i\pi} = \cos \pi + i \sin \pi = -1$ .

4.  $\exp(2 - \frac{\pi}{2}i) = e^2 (\cos \frac{\pi}{2} - i \sin \frac{\pi}{2}) = -e^2 i$ .

6.  $\pi^{-1+2i} = \exp[(-1 + 2i)\ln \pi] = \exp(-\ln \pi) \exp(2 \ln \pi i) = \frac{1}{\pi} \exp(2 \ln \pi i) = \frac{1}{\pi} [\cos(2 \ln \pi) + i \sin(2 \ln \pi)]$ .

8. The characteristic equation is  $r^2 - 2r + 6 = 0$ , with roots  $r = 1 \pm i\sqrt{5}$ . Hence the general solution is  $y = c_1 e^t \cos \sqrt{5}t + c_2 e^t \sin \sqrt{5}t$ .

9. The characteristic equation is  $r^2 + 2r - 8 = 0$ , with roots  $r = -4, 2$ . The roots are *real* and different, hence the general solution is  $y = c_1 e^{-4t} + c_2 e^{2t}$ .

10. The characteristic equation is  $r^2 + 2r + 2 = 0$ , with roots  $r = -1 \pm i$ . Hence the general solution is  $y = c_1 e^{-t} \cos t + c_2 e^{-t} \sin t$ .

12. The characteristic equation is  $4r^2 + 9 = 0$ , with roots  $r = \pm \frac{3}{2}i$ . Hence the general solution is  $y = c_1 \cos \frac{3}{2}t + c_2 \sin \frac{3}{2}t$ .

13. The characteristic equation is  $r^2 + 2r + 1.25 = 0$ , with roots  $r = -1 \pm \frac{1}{2}i$ . Hence the general solution is  $y = c_1 e^{-t} \cos \frac{1}{2}t + c_2 e^{-t} \sin \frac{1}{2}t$ .

15. The characteristic equation is  $r^2 + r + 1.25 = 0$ , with roots  $r = -\frac{1}{2} \pm i$ . Hence the general solution is  $y = c_1 e^{-t/2} \cos t + c_2 e^{-t/2} \sin t$ .

16. The characteristic equation is  $r^2 + 4r + 6.25 = 0$ , with roots  $r = -2 \pm \frac{3}{2}i$ . Hence the general solution is  $y = c_1 e^{-2t} \cos \frac{3}{2}t + c_2 e^{-2t} \sin \frac{3}{2}t$ .

17. The characteristic equation is  $r^2 + 4 = 0$ , with roots  $r = \pm 2i$ . Hence the general solution is  $y = c_1 \cos 2t + c_2 \sin 2t$ . Its derivative is  $y' = -2c_1 \sin 2t + 2c_2 \cos 2t$ . Based on the first condition,  $y(0) = 0$ , we require that  $c_1 = 0$ . In order to satisfy the condition  $y'(0) = 1$ , we find that  $2c_2 = 1$ . The constants are  $c_1 = 0$  and  $c_2 = 1/2$ . Hence the specific solution is  $y(t) = \frac{1}{2} \sin 2t$ .

19. The characteristic equation is  $r^2 - 2r + 5 = 0$ , with roots  $r = 1 \pm 2i$ . Hence the general solution is  $y = c_1 e^t \cos 2t + c_2 e^t \sin 2t$ . Based on the condition,  $y(\pi/2) = 0$ , we require that  $c_1 = 0$ . It follows that  $y = c_2 e^t \sin 2t$ , and so the first derivative is  $y' = c_2 e^t \sin 2t + 2c_2 e^t \cos 2t$ . In order to satisfy the condition  $y'(\pi/2) = 2$ , we find that  $-2e^{\pi/2} c_2 = 2$ . Hence we have  $c_2 = -e^{-\pi/2}$ . Therefore the specific solution is  $y(t) = -e^{t-\pi/2} \sin 2t$ .

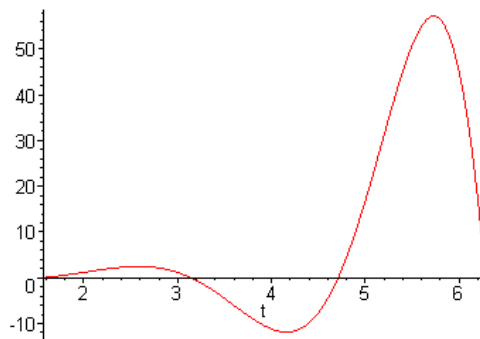

20. The characteristic equation is  $r^2 + 1 = 0$ , with roots  $r = \pm i$ . Hence the general solution is  $y = c_1 \cos t + c_2 \sin t$ . Its derivative is  $y' = -c_1 \sin t + c_2 \cos t$ . Based on the first condition,  $y(\pi/3) = 2$ , we require that  $c_1 + \sqrt{3}c_2 = 4$ . In order to satisfy the condition  $y'(\pi/3) = -4$ , we find that  $-\sqrt{3}c_1 + c_2 = -8$ . Solving these for the constants,  $c_1 = 1 + 2\sqrt{3}$  and  $c_2 = \sqrt{3} - 2$ . Hence the specific solution is a steady oscillation, given by  $y(t) = (1 + 2\sqrt{3})\cos t + (\sqrt{3} - 2)\sin t$ .

21. From Prob. 15, the general solution is  $y = c_1 e^{-t/2} \cos t + c_2 e^{-t/2} \sin t$ . Invoking the first initial condition,  $y(0) = 3$ , which implies that  $c_1 = 3$ . Substituting, it follows that  $y = 3e^{-t/2} \cos t + c_2 e^{-t/2} \sin t$ , and so the first derivative is

$$y' = -\frac{3}{2}e^{-t/2} \cos t - 3e^{-t/2} \sin t + c_2 e^{-t/2} \cos t - \frac{c_2}{2}e^{-t/2} \sin t.$$

Invoking the initial condition,  $y'(0) = 1$ , we find that  $-\frac{3}{2} + c_2 = 1$ , and so  $c_2 = \frac{5}{2}$ . Hence the specific solution is  $y(t) = 3e^{-t/2} \cos t + \frac{5}{2}e^{-t/2} \sin t$ .

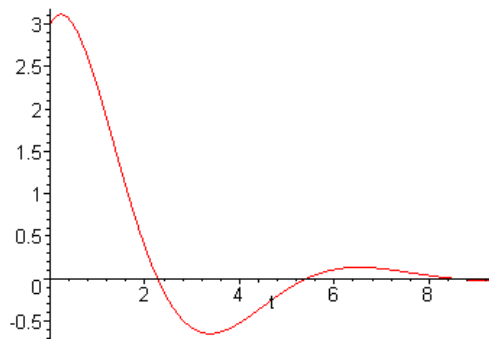

24(a). The characteristic equation is  $5r^2 + 2r + 7 = 0$ , with roots  $r = -\frac{1}{5} \pm i\frac{\sqrt{34}}{5}$ . The solution is  $u = c_1 e^{-t/5} \cos \frac{\sqrt{34}}{5}t + c_2 e^{-t/5} \sin \frac{\sqrt{34}}{5}t$ . Invoking the given initial conditions, we obtain the equations for the coefficients:  $c_1 = 2$ ,  $-2 + \sqrt{34}c_2 = 5$ . That is,  $c_1 = 2$ ,  $c_2 = 7/\sqrt{34}$ . Hence the specific solution is

$$u(t) = 2e^{-t/5} \cos \frac{\sqrt{34}}{5}t + \frac{7}{\sqrt{34}}e^{-t/5} \sin \frac{\sqrt{34}}{5}t.$$

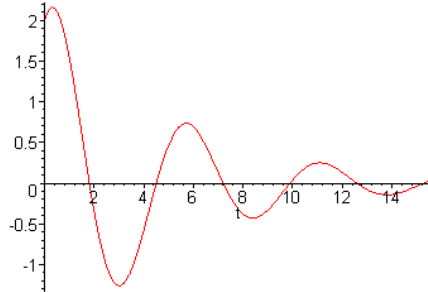

(b). Based on the graph of  $u(t)$ ,  $T$  is in the interval  $14 < t < 16$ . A numerical solution on that interval yields  $T \approx 14.5115$ .

26(a). The characteristic equation is  $r^2 + 2ar + (a^2 + 1) = 0$ , with roots  $r = -a \pm i$ . Hence the general solution is  $y(t) = c_1 e^{-at} \cos t + c_2 e^{-at} \sin t$ . Based on the initial conditions, we find that  $c_1 = 1$  and  $c_2 = a$ . Therefore the specific solution is given by

$$\begin{aligned} y(t) &= e^{-at} \cos t + a e^{-at} \sin t \\ &= \sqrt{1 + a^2} e^{-at} \cos(t - \phi), \end{aligned}$$

in which  $\phi = \tan^{-1}(a)$ .

(b). For estimation, note that  $|y(t)| \leq \sqrt{1 + a^2} e^{-at}$ . Now consider the inequality  $\sqrt{1 + a^2} e^{-at} \leq 1/10$ . The inequality holds for  $t \geq \frac{1}{a} \ln [10\sqrt{1 + a^2}]$ . Therefore  $T \leq \frac{1}{a} \ln [10\sqrt{1 + a^2}]$ . Setting  $a = 1$ , numerical analysis gives  $T \approx 1.8763$ .

(c). Similarly,  $T_{1/4} \approx 7.4284$ ,  $T_{1/2} \approx 4.3003$ ,  $T_2 \approx 1.5116$ ,  $T_3 \approx 1.1496$ .

(d).

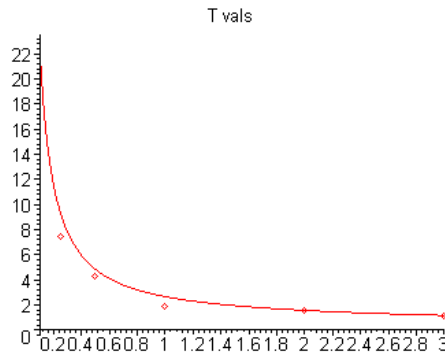

Note that the estimates  $T_a$  approach the graph of  $\frac{1}{a} \ln \left[ 10\sqrt{1+a^2} \right]$  as  $a$  gets large.

27. Direct calculation gives the result. On the other hand, it was shown in Prob. 3.3.23 that  $W(fg, fh) = f^2W(g, h)$ . Hence

$$\begin{aligned} W(e^{\lambda t} \cos \mu t, e^{\lambda t} \sin \mu t) &= e^{2\lambda t} W(\cos \mu t, \sin \mu t) \\ &= e^{2\lambda t} [\cos \mu t (\sin \mu t)' - (\cos \mu t)' \sin \mu t] \\ &= \mu e^{2\lambda t}. \end{aligned}$$

28(a). Clearly,  $y_1$  and  $y_2$  are solutions. Also,  $W(\cos t, \sin t) = \cos^2 t + \sin^2 t = 1$ .

(b).  $y' = i e^{it}$ ,  $y'' = i^2 e^{it} = -e^{it}$ . Evidently,  $y$  is a solution and so  $y = c_1 y_1 + c_2 y_2$ .

(c). Setting  $t = 0$ ,  $1 = c_1 \cos 0 + c_2 \sin 0$ , and  $c_1 = 0$ . Differentiating,  $i e^{it} = c_2 \cos t$ . Setting  $t = 0$ ,  $i = c_2 \cos 0$  and hence  $c_2 = i$ . Therefore  $e^{it} = \cos t + i \sin t$ .

29. Euler's formula is  $e^{it} = \cos t + i \sin t$ . It follows that  $e^{-it} = \cos t - i \sin t$ . Adding these equations,  $e^{it} + e^{-it} = 2 \cos t$ . Subtracting the two equations results in  $e^{it} - e^{-it} = 2i \sin t$ .

30. Let  $r_1 = \lambda_1 + i\mu_1$ , and  $r_2 = \lambda_2 + i\mu_2$ . Then

$$\begin{aligned} \exp(r_1 + r_2)t &= \exp[(\lambda_1 + \lambda_2)t + i(\mu_1 + \mu_2)t] \\ &= e^{(\lambda_1 + \lambda_2)t} [\cos(\mu_1 + \mu_2)t + i \sin(\mu_1 + \mu_2)t] \\ &= e^{(\lambda_1 + \lambda_2)t} [(\cos \mu_1 t + i \sin \mu_1 t)(\cos \mu_2 t + i \sin \mu_2 t)] \\ &= e^{\lambda_1 t} (\cos \mu_1 t + i \sin \mu_1 t) \cdot e^{\lambda_2 t} (\cos \mu_2 t + i \sin \mu_2 t) \end{aligned}$$

Hence  $e^{(r_1+r_2)t} = e^{r_1 t} e^{r_2 t}$ .

32. If  $\phi(t) = u(t) + i v(t)$  is a solution, then

$$(u + iv)'' + p(t)(u + iv)' + q(t)(u + iv) = 0,$$

and  $(u'' + iv'') + p(t)(u' + iv') + q(t)(u + iv) = 0$ . After expanding the equation and separating the *real* and *imaginary* parts,

$$\begin{aligned} u'' + p(t)u' + q(t)u &= 0 \\ v'' + p(t)v' + q(t)v &= 0 \end{aligned}$$

Hence both  $u(t)$  and  $v(t)$  are solutions.

34(a). By the *chain rule*,  $y(x)' = \frac{dy}{dx} x'$ . In general,  $\frac{dz}{dt} = \frac{dz}{dx} \frac{dx}{dt}$ . Setting  $z = \frac{dy}{dt}$ , we have  $\frac{d^2y}{dt^2} = \frac{dz}{dx} \frac{dx}{dt} = \frac{d}{dx} \left[ \frac{dy}{dx} \frac{dx}{dt} \right] \frac{dx}{dt} = \left[ \frac{d^2y}{dx^2} \frac{dx}{dt} \right] \frac{dx}{dt} + \frac{dy}{dx} \frac{d}{dx} \left[ \frac{dx}{dt} \right] \frac{dx}{dt}$ . However,  $\frac{d}{dx} \left[ \frac{dx}{dt} \right] \frac{dx}{dt} = \left[ \frac{d^2x}{dt^2} \right] \frac{dt}{dx} \cdot \frac{dx}{dt} = \frac{d^2x}{dt^2}$ . Hence  $\frac{d^2y}{dt^2} = \frac{d^2y}{dx^2} \left[ \frac{dx}{dt} \right]^2 + \frac{dy}{dx} \frac{d^2x}{dt^2}$ .

(b). Substituting the results in Part(a) into the general ODE,  $y'' + p(t)y' + q(t)y = 0$ , we find that

$$\frac{d^2y}{dx^2} \left[ \frac{dx}{dt} \right]^2 + \frac{dy}{dx} \frac{d^2x}{dt^2} + p(t) \frac{dy}{dx} \frac{dx}{dt} + q(t)y = 0.$$

Collecting the terms,

$$\left[ \frac{dx}{dt} \right]^2 \frac{d^2y}{dx^2} + \left[ \frac{d^2x}{dt^2} + p(t) \frac{dx}{dt} \right] \frac{dy}{dx} + q(t)y = 0.$$

(c). Assuming  $\left[ \frac{dx}{dt} \right]^2 = k q(t)$ , and  $q(t) > 0$ , we find that  $\frac{dx}{dt} = \sqrt{k q(t)}$ , which can be integrated. That is,  $x = \xi(t) = \int \sqrt{k q(t)} dt$ .

(d). Let  $k = 1$ . It follows that  $\frac{d^2x}{dt^2} + p(t) \frac{dx}{dt} = \frac{d\xi}{dt} + p(t)\xi(t) = \frac{q'}{2\sqrt{q}} + p\sqrt{q}$ . Hence

$$\left[ \frac{d^2x}{dt^2} + p(t) \frac{dx}{dt} \right] / \left[ \frac{dx}{dt} \right]^2 = \frac{q'(t) + 2p(t)q(t)}{2[q(t)]^{3/2}}.$$

As long as  $dx/dt \neq 0$ , the differential equation can be expressed as

$$\frac{d^2y}{dx^2} + \left[ \frac{q'(t) + 2p(t)q(t)}{2[q(t)]^{3/2}} \right] \frac{dy}{dx} + y = 0.$$

\* For the case  $q(t) < 0$ , write  $q(t) = -[-q(t)]$ , and set  $\left[ \frac{dx}{dt} \right]^2 = -q(t)$ .

36.  $p(t) = 3t$  and  $q(t) = t^2$ . We have  $x = \int t dt = t^2/2$ . Furthermore,

$$\frac{q'(t) + 2p(t)q(t)}{2[q(t)]^{3/2}} = (1 + 3t^2)/t^2.$$

The ratio is *not* constant, and therefore the equation cannot be transformed.

37.  $p(t) = t - 1/t$  and  $q(t) = t^2$ . We have  $x = \int t dt = t^2/2$ . Furthermore,

$$\frac{q'(t) + 2p(t)q(t)}{2[q(t)]^{3/2}} = 1.$$

The ratio is constant, and therefore the equation can be transformed. From Prob. 35, the transformed equation is

$$\frac{d^2y}{dx^2} + \frac{dy}{dx} + y = 0.$$

Based on the methods in this section, the characteristic equation is  $r^2 + r + 1 = 0$ , with roots  $r = -\frac{1}{2} \pm i\frac{\sqrt{3}}{2}$ . The general solution is

$$y(x) = c_1 e^{-x/2} \cos \sqrt{3}x/2 + c_2 e^{-x/2} \sin \sqrt{3}x/2.$$

Since  $x = t^2/2$ , the solution in the original variable  $t$  is

$$y(t) = e^{-t^2/4} \left[ c_1 \cos \left( \sqrt{3} t^2/4 \right) + c_2 \sin \left( \sqrt{3} t^2/4 \right) \right].$$

40.  $p(t) = 4/t$  and  $q(t) = 2/t^2$ . We have  $x = \sqrt{2} \int t^{-1} dt = \sqrt{2} \ln t$ . Furthermore,

$$\frac{q'(t) + 2p(t)q(t)}{2[q(t)]^{3/2}} = \frac{3}{\sqrt{2}}.$$

The ratio is constant, and therefore the equation can be transformed. In fact, we obtain

$$\frac{d^2y}{dx^2} + \frac{3}{\sqrt{2}} \frac{dy}{dx} + y = 0.$$

Based on the methods in this section, the characteristic equation is  $\sqrt{2} r^2 + 3r + \sqrt{2} = 0$ , with roots  $r = -\sqrt{2}, -1/\sqrt{2}$ . The general solution is

$$y(x) = c_1 e^{-\sqrt{2}x} + c_2 e^{-x/\sqrt{2}}.$$

Since  $x = \sqrt{2} \ln t$ , the solution in the original variable  $t$  is

$$\begin{aligned} y(t) &= c_1 e^{-2 \ln t} + c_2 e^{-\ln t} \\ &= c_1 t^{-2} + c_2 t^{-1}. \end{aligned}$$

41.  $p(t) = 3/t$  and  $q(t) = 1.25/t^2$ . We have  $x = \sqrt{1.25} \int t^{-1} dt = \sqrt{1.25} \ln t$ .

Checking the feasibility of the transformation,

$$\frac{q'(t) + 2p(t)q(t)}{2[q(t)]^{3/2}} = \frac{4}{\sqrt{5}}.$$

The ratio is constant, and therefore the equation can be transformed. In fact, we obtain

$$\frac{d^2y}{dx^2} + \frac{4}{\sqrt{5}} \frac{dy}{dx} + y = 0.$$

Based on the methods in this section, the characteristic equation is

$\sqrt{5} r^2 + 4r + \sqrt{5} = 0$ , with roots  $r = -\frac{2}{\sqrt{5}} \pm i \frac{1}{\sqrt{5}}$ . The general solution is

$$y(x) = c_1 e^{-2x/\sqrt{5}} \cos x/\sqrt{5} + c_2 e^{-2x/\sqrt{5}} \sin x/\sqrt{5}.$$

Since  $2x/\sqrt{5} = \ln t$ , the solution in the original variable  $t$  is



$$\begin{aligned}
 y(t) &= c_1 e^{-\ln t} \cos(\ln \sqrt{t}) + c_2 e^{-\ln t} \sin(\ln \sqrt{t}) \\
 &= t^{-1} [c_1 \cos(\ln \sqrt{t}) + c_2 \sin(\ln \sqrt{t})].
 \end{aligned}$$

42.  $p(t) = -4/t$  and  $q(t) = -6/t^2$ . Set  $x = \sqrt{6} \int t^{-1} dt = \sqrt{6} \ln t$ .

Checking the feasibility of the transformation (\*see Prob. 34 d, with  $q < 0$ ),

$$\frac{-q'(t) - 2p(t)q(t)}{2[-q(t)]^{3/2}} = \frac{-5}{\sqrt{6}}.$$

The ratio is constant, and therefore the equation can be transformed. In fact, we obtain

$$\frac{d^2 y}{dx^2} + \frac{-5}{\sqrt{6}} \frac{dy}{dx} - y = 0.$$

Based on the methods in this section, the characteristic equation is  $\sqrt{6} r^2 - 5$

$r - \sqrt{6} = 0$ ,

with roots  $r = \sqrt{6}$ ,  $-1/\sqrt{6}$ . The general solution is

$$y(x) = c_1 e^{\sqrt{6}x} + c_2 e^{-x/\sqrt{6}}.$$

Since  $x = \sqrt{6} \ln t$ , the solution in the original variable  $t$  is

$$\begin{aligned}
 y(t) &= c_1 e^{6 \ln t} + c_2 e^{-\ln t} \\
 &= c_1 t^6 + c_2 t^{-1}.
 \end{aligned}$$

## Section 3.5

2. The characteristic equation is  $9r^2 + 6r + 1 = 0$ , with the *double* root  $r = -1/3$ . Based on the discussion in this section, the general solution is  $y(t) = c_1 e^{-t/3} + c_2 t e^{-t/3}$ .

3. The characteristic equation is  $4r^2 - 4r - 3 = 0$ , with roots  $r = -1/2, 3/2$ . The general solution is  $y(t) = c_1 e^{-t/2} + c_2 e^{3t/2}$ .

4. The characteristic equation is  $4r^2 + 12r + 9 = 0$ , with the *double* root  $r = -3/2$ . Based on the discussion in this section, the general solution is  $y(t) = (c_1 + c_2 t) e^{-3t/2}$ .

5. The characteristic equation is  $r^2 - 2r + 10 = 0$ , with complex roots  $r = 1 \pm 3i$ . The general solution is  $y(t) = c_1 e^t \cos 3t + c_2 e^t \sin 3t$ .

6. The characteristic equation is  $r^2 - 6r + 9 = 0$ , with the *double* root  $r = 3$ . The general solution is  $y(t) = c_1 e^{3t} + c_2 t e^{3t}$ .

7. The characteristic equation is  $4r^2 + 17r + 4 = 0$ , with roots  $r = -1/4, -4$ . The general solution is  $y(t) = c_1 e^{-t/4} + c_2 e^{-4t}$ .

8. The characteristic equation is  $16r^2 + 24r + 9 = 0$ , with the *double* root  $r = -3/4$ . The general solution is  $y(t) = c_1 e^{-3t/4} + c_2 t e^{-3t/4}$ .

10. The characteristic equation is  $2r^2 + 2r + 1 = 0$ , with complex roots  $r = -\frac{1}{2} \pm \frac{1}{2}i$ . The general solution is  $y(t) = c_1 e^{-t/2} \cos t/2 + c_2 e^{-t/2} \sin t/2$ .

11. The characteristic equation is  $9r^2 - 12r + 4 = 0$ , with the *double* root  $r = 2/3$ . The general solution is  $y(t) = c_1 e^{2t/3} + c_2 t e^{2t/3}$ . Invoking the first initial condition, it follows that  $c_1 = 2$ . Now  $y'(t) = (4/3 + c_2) e^{2t/3} + 2c_2 t e^{2t/3}/3$ . Invoking the second initial condition,  $4/3 + c_2 = -1$ , or  $c_2 = -7/3$ . Hence  $y(t) = 2e^{2t/3} - \frac{7}{3}t e^{2t/3}$ . Since the *second* term dominates for large  $t$ ,  $y(t) \rightarrow -\infty$ .

13. The characteristic equation is  $9r^2 + 6r + 82 = 0$ , with complex roots  $r = -\frac{1}{3} \pm 3i$ . The general solution is  $y(t) = c_1 e^{-t/3} \cos 3t + c_2 e^{-t/3} \sin 3t$ . Based on the first initial condition,  $c_1 = -1$ . Invoking the second initial condition,  $1/3 + 3c_2 = 2$ , or  $c_2 = \frac{5}{9}$ . Hence  $y(t) = -e^{-t/3} \cos 3t + \frac{5}{9} e^{-t/3} \sin 3t$ .

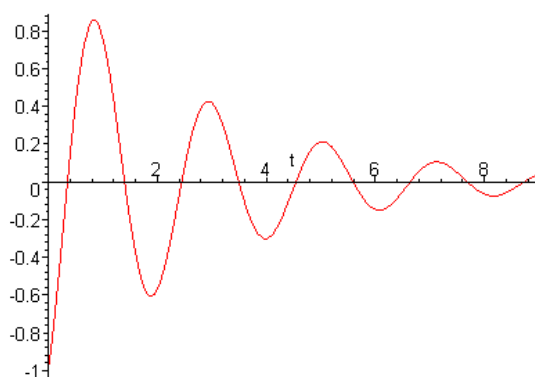

15(a). The characteristic equation is  $4r^2 + 12r + 9 = 0$ , with the *double* root  $r = -\frac{3}{2}$ . The general solution is  $y(t) = c_1 e^{-3t/2} + c_2 t e^{-3t/2}$ . Invoking the first initial condition, it follows that  $c_1 = 1$ . Now  $y'(t) = (-3/2 + c_2)e^{2t/3} - \frac{3}{2}c_2 t e^{2t/3}$ . The second initial condition requires that  $-3/2 + c_2 = -4$ , or  $c_2 = -5/2$ . Hence the specific solution is  $y(t) = e^{-3t/2} - \frac{5}{2}t e^{-3t/2}$ .

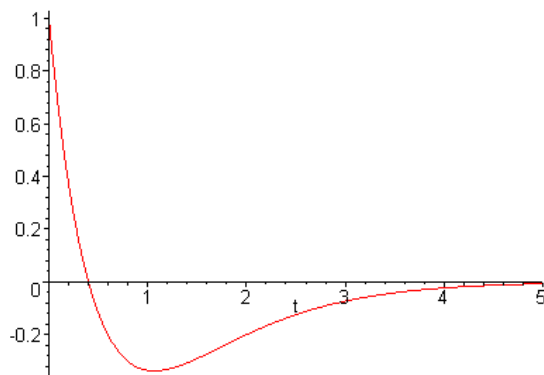

(b). The solution crosses the  $x$ -axis at  $t = 0.4$ .

(c). The solution has a minimum at the point  $(16/15, -5e^{-8/5}/3)$ .

(d). Given that  $y'(0) = b$ , we have  $-3/2 + c_2 = b$ , or  $c_2 = b + 3/2$ . Hence the solution is  $y(t) = e^{-3t/2} + (b + \frac{3}{2})t e^{-3t/2}$ . Since the *second* term dominates, the *long-term* solution depends on the *sign* of the coefficient  $b + \frac{3}{2}$ . The critical value is  $b = -\frac{3}{2}$ .

16. The characteristic roots are  $r_1 = r_2 = 1/2$ . Hence the general solution is given by  $y(t) = c_1 e^{t/2} + c_2 t e^{t/2}$ . Invoking the initial conditions, we require that  $c_1 = 2$ , and that  $1 + c_2 = b$ . The specific solution is  $y(t) = 2e^{t/2} + (b - 1)t e^{t/2}$ . Since the *second* term dominates, the *long-term* solution depends on the *sign* of the coefficient  $b - 1$ . The critical value is  $b = 1$ .

18(a). The characteristic roots are  $r_1 = r_2 = -2/3$ . Therefore the general solution is given by  $y(t) = c_1 e^{-2t/3} + c_2 t e^{-2t/3}$ . Invoking the initial conditions, we require that  $c_1 = a$ , and that  $-2a/3 + c_2 = -1$ . After solving for the coefficients, the specific solution is  $y(t) = a e^{-2t/3} + \left(\frac{2a}{3} - 1\right) t e^{-2t/3}$ .

(b). Since the *second* term dominates, the *long-term* solution depends on the *sign* of the coefficient  $\frac{2a}{3} - 1$ . The critical value is  $a = 3/2$ .

20(a). The characteristic equation is  $r^2 + 2ar + a^2 = 0$ , with *double* root  $r = -a$ . Hence one solution is  $y_1(t) = c_1 e^{-at}$ .

(b). Recall that the Wronskian satisfies the differential equation  $W' + 2aW = 0$ . The solution of this equation is  $W(t) = c e^{-2at}$ .

(c). By definition,  $W = y_1 y_2' - y_1' y_2$ . Hence  $c_1 e^{-at} y_2' + a c_1 e^{-at} y_2 = c e^{-2at}$ . That is,  $y_2' + a y_2 = c_2 e^{-at}$ . This equation is first order *linear*, with general solution  $y_2(t) = c_2 t e^{-at} + c_3 e^{-at}$ . Setting  $c_2 = 1$  and  $c_3 = 0$ , we obtain  $y_2(t) = t e^{-at}$ .

22(a). Write  $ar^2 + br + c = a\left(r^2 + \frac{b}{a}r + \frac{c}{a}\right)$ . It follows that  $\frac{b}{a} = -2r_1$  and  $\frac{c}{a} = r_1^2$ . Hence  $ar^2 + br + c = ar^2 - 2ar_1r + ar_1^2 = a(r^2 - 2r_1r + r_1^2) = a(r - r_1)^2$ . We find that  $L[e^{rt}] = (ar^2 + br + c)e^{rt} = a(r - r_1)^2 e^{rt}$ . Setting  $r = r_1$ ,  $L[e^{r_1 t}] = 0$ .

(b). Differentiating Eq.(i) with respect to  $r$ ,

$$\frac{\partial}{\partial r} L[e^{rt}] = a t e^{rt} (r - r_1)^2 + 2a e^{rt} (r - r_1).$$

Now observe that

$$\begin{aligned} \frac{\partial}{\partial r} L[e^{rt}] &= \frac{\partial}{\partial r} \left[ a \frac{\partial^2}{\partial t^2} (e^{rt}) + b \frac{\partial}{\partial t} (e^{rt}) + c (e^{rt}) \right] \\ &= \left[ a \frac{\partial^2}{\partial t^2} \left( \frac{\partial}{\partial r} e^{rt} \right) + b \frac{\partial}{\partial t} \left( \frac{\partial}{\partial r} e^{rt} \right) + c \left( \frac{\partial}{\partial r} e^{rt} \right) \right] \\ &= a \frac{\partial^2}{\partial t^2} (t e^{rt}) + b \frac{\partial}{\partial t} (t e^{rt}) + c (t e^{rt}). \end{aligned}$$

Hence  $L[t e^{r_1 t}] = a t e^{r_1 t} (r - r_1)^2 + 2a e^{r_1 t} (r - r_1)$ . Setting  $r = r_1$ ,  $L[t e^{r_1 t}] = 0$ .

23. Set  $y_2(t) = t^2 v(t)$ . Substitution into the ODE results in

$$t^2 (t^2 v'' + 4t v' + 2v) - 4t (t^2 v' + 2tv) + 6t^2 v = 0.$$

After collecting terms, we end up with  $t^4 v'' = 0$ . Hence  $v(t) = c_1 + c_2 t$ , and thus  $y_2(t) = c_1 t^2 + c_2 t^3$ . Setting  $c_1 = 0$  and  $c_2 = 1$ , we obtain  $y_2(t) = t^3$ .

24. Set  $y_2(t) = t v(t)$ . Substitution into the ODE results in

$$t^2(tv'' + 2v') + 2t(tv' + v) - 2tv = 0.$$

After collecting terms, we end up with  $t^3v'' + 4t^2v' = 0$ . This equation is *linear* in the variable  $w = v'$ . It follows that  $v'(t) = ct^{-4}$ , and  $v(t) = c_1t^{-3} + c_2$ . Thus  $y_2(t) = c_1t^{-2} + c_2t$ . Setting  $c_1 = 1$  and  $c_2 = 0$ , we obtain  $y_2(t) = t^{-2}$ .

26. Set  $y_2(t) = tv(t)$ . Substitution into the ODE results in  $v'' - v' = 0$ . This ODE is *linear* in the variable  $w = v'$ . It follows that  $v'(t) = c_1e^t$ , and  $v(t) = c_1e^t + c_2$ . Thus  $y_2(t) = c_1te^t + c_2t$ . Setting  $c_1 = 1$  and  $c_2 = 0$ , we obtain  $y_2(t) = te^t$ .

28. Set  $y_2(x) = e^xv(x)$ . Substitution into the ODE results in

$$v'' + \frac{x-2}{x-1}v' = 0.$$

This ODE is *linear* in the variable  $w = v'$ . An integrating factor is

$$\begin{aligned}\mu &= \exp\left(\int \frac{x-2}{x-1}dx\right) \\ &= \frac{e^x}{x-1}.\end{aligned}$$

Rewrite the equation as  $\left[\frac{e^xv'}{x-1}\right]' = 0$ , from which it follows that  $v'(x) = c(x-1)e^{-x}$ . Hence  $v(x) = c_1xe^{-x} + c_2$  and  $y_2(x) = c_1x + c_2e^x$ . Setting  $c_1 = 1$  and  $c_2 = 0$ , we obtain  $y_2(x) = x$ .

29. Set  $y_2(x) = y_1(x)v(x)$ , in which  $y_1(x) = x^{1/4}\exp(2\sqrt{x})$ . It can be verified that  $y_1$  is a solution of the ODE, that is,  $x^2y_1'' - (x - 0.1875)y_1 = 0$ . Substitution of the given form of  $y_2$  results in the differential equation

$$2x^{9/4}v'' + (4x^{7/4} + x^{5/4})v' = 0.$$

This ODE is *linear* in the variable  $w = v'$ . An integrating factor is

$$\begin{aligned}\mu &= \exp\left(\int \left[2x^{-1/2} + \frac{1}{2x}\right]dx\right) \\ &= \sqrt{x}\exp(4\sqrt{x}).\end{aligned}$$

Rewrite the equation as  $[\sqrt{x}\exp(4\sqrt{x})v']' = 0$ , from which it follows that

$$v'(x) = c\exp(-4\sqrt{x})/\sqrt{x}.$$

Integrating,  $v(x) = c_1\exp(-4\sqrt{x}) + c_2$  and as a result,

$$y_2(x) = c_1x^{1/4}\exp(-2\sqrt{x}) + c_2x^{1/4}\exp(2\sqrt{x}).$$

Setting  $c_1 = 1$  and  $c_2 = 0$ , we obtain  $y_2(x) = x^{1/4}\exp(-2\sqrt{x})$ .

32. Direct substitution verifies that  $y_1(t) = \exp(-\delta x^2/2)$  is a solution of the ODE. Now set  $y_2(x) = y_1(x)v(x)$ . Substitution of  $y_2$  into the ODE results in

$$v'' - \delta x v' = 0.$$

This ODE is *linear* in the variable  $w = v'$ . An integrating factor is  $\mu = \exp(-\delta x^2/2)$ . Rewrite the equation as  $[\exp(-\delta x^2/2)v']' = 0$ , from which it follows that

$$v'(x) = c_1 \exp(\delta x^2/2).$$

Integrating, we obtain

$$v(x) = c_1 \int_{x_0}^x \exp(\delta u^2/2) du + v(x_0).$$

Hence

$$y_2(x) = c_1 \exp(-\delta x^2/2) \int_{x_0}^x \exp(\delta u^2/2) du + c_2 \exp(-\delta x^2/2).$$

Setting  $c_2 = 0$ , we obtain a second independent solution.

34. After writing the ODE in standard form, we have  $p(t) = 3/t$ . Based on *Abel's identity*,  $W(y_1, y_2) = c_1 \exp(-\int \frac{3}{t} dt) = c_1 t^{-3}$ . As shown in Prob. 33, two solutions of a second order linear equation satisfy

$$(y_2/y_1)' = W(y_1, y_2)/y_1^2.$$

In the given problem,  $y_1(t) = t^{-1}$ . Hence  $(t y_2)' = c_1 t^{-1}$ . Integrating both sides of the equation,  $y_2(t) = c_1 t^{-1} \ln t + c_2 t^{-1}$ .

36. After writing the ODE in standard form, we have  $p(x) = -x/(x-1)$ . Based on *Abel's identity*,  $W(y_1, y_2) = c \exp(\int \frac{x}{x-1} dx) = c e^x(x-1)$ . Two solutions of a second order linear equation satisfy

$$(y_2/y_1)' = W(y_1, y_2)/y_1^2.$$

In the given problem,  $y_1(x) = e^x$ . Hence  $(e^{-x} y_2)' = c e^{-x}(x-1)$ . Integrating both sides of the equation,  $y_2(x) = c_1 x + c_2 e^x$ . Setting  $c_1 = 1$  and  $c_2 = 0$ , we obtain  $y_2(x) = x$ .

37. Write the ODE in standard form to find  $p(x) = 1/x$ . Based on *Abel's identity*,  $W(y_1, y_2) = c \exp(-\int \frac{1}{x} dx) = c x^{-1}$ . Two solutions of a second order linear ODE satisfy  $(y_2/y_1)' = W(y_1, y_2)/y_1^2$ . In the given problem,  $y_1(x) = x^{-1/2} \sin x$ . Hence

$$\left( \frac{\sqrt{x}}{\sin x} y_2 \right)' = c \frac{1}{\sin^2 x}.$$

Integrating both sides of the equation,  $y_2(x) = c_1x^{-1/2}\cos x + c_2x^{-1/2}\sin x$ . Setting  $c_1 = 1$  and  $c_2 = 0$ , we obtain  $y_2(x) = x^{-1/2}\cos x$ .

39(a). The characteristic equation is  $ar^2 + c = 0$ . If  $a, c > 0$ , then the roots are  $r_{1,2} = \pm i\sqrt{c/a}$ . The general solution is

$$y(t) = c_1\cos\sqrt{\frac{c}{a}}t + c_2\sin\sqrt{\frac{c}{a}}t,$$

which is bounded.

(b). The characteristic equation is  $ar^2 + br = 0$ . The roots are  $r_{1,2} = 0, -b/a$ , and hence the general solution is  $y(t) = c_1 + c_2\exp(-bt/a)$ . Clearly,  $y(t) \rightarrow c_1$ .

40. Note that  $\cos t \sin t = \frac{1}{2}\sin 2t$ . So that  $1 - k \cos t \sin t = 1 - \frac{k}{2}\sin 2t$ . If  $0 < k < 2$ , then  $\frac{k}{2}\sin 2t < |\sin 2t|$  and  $-\frac{k}{2}\sin 2t > -|\sin 2t|$ . Hence

$$\begin{aligned} 1 - k \cos t \sin t &= 1 - \frac{k}{2}\sin 2t \\ &> 1 - |\sin 2t| \\ &\geq 0. \end{aligned}$$

41.  $p(t) = -3/t$  and  $q(t) = 4/t^2$ . We have  $x = 2\int t^{-1}dt = 2\ln t$ , and  $t = e^{x/2}$ . Furthermore,

$$\frac{q'(t) + 2p(t)q(t)}{2[q(t)]^{3/2}} = -2.$$

The ratio is constant, and therefore the equation can be transformed. In fact, we obtain

$$\frac{d^2y}{dx^2} - 2\frac{dy}{dx} + y = 0.$$

The general solution of this ODE is  $y(x) = c_1e^x + c_2xe^x$ . In terms of the original independent variable,  $y(t) = c_1t^2 + c_2t^2 \ln t$ .

## Section 3.6

2. The characteristic equation for the homogeneous problem is  $r^2 + 2r + 5 = 0$ , with complex roots  $r = -1 \pm 2i$ . Hence  $y_c(t) = c_1 e^{-t} \cos 2t + c_2 e^{-t} \sin 2t$ . Since the function  $g(t) = 3 \sin 2t$  is not proportional to the solutions of the homogeneous equation, set  $Y = A \cos 2t + B \sin 2t$ . Substitution into the given ODE, and comparing the coefficients, results in the system of equations  $B - 4A = 3$  and  $A + 4B = 0$ . Hence  $Y = -\frac{12}{17} \cos 2t + \frac{3}{17} \sin 2t$ . The general solution is  $y(t) = y_c(t) + Y$ .

3. The characteristic equation for the homogeneous problem is  $r^2 - 2r - 3 = 0$ , with roots  $r = -1, 3$ . Hence  $y_c(t) = c_1 e^{-t} + c_2 e^{3t}$ . Note that the assignment  $Y = Ate^{-t}$  is *not* sufficient to match the coefficients. Try  $Y = Ate^{-t} + Bt^2 e^{-t}$ . Substitution into the differential equation, and comparing the coefficients, results in the system of equations  $-4A + 2B = 0$  and  $-8B = -3$ . Hence  $Y = \frac{3}{16} te^{-t} + \frac{3}{8} t^2 e^{-t}$ . The general solution is  $y(t) = y_c(t) + Y$ .

5. The characteristic equation for the homogeneous problem is  $r^2 + 9 = 0$ , with complex roots  $r = \pm 3i$ . Hence  $y_c(t) = c_1 \cos 3t + c_2 \sin 3t$ . To simplify the analysis, set  $g_1(t) = 6$  and  $g_2(t) = t^2 e^{3t}$ . By inspection, we have  $Y_1 = 2/3$ . Based on the form of  $g_2$ , set  $Y_2 = Ae^{3t} + Bte^{3t} + Ct^2 e^{3t}$ . Substitution into the differential equation, and comparing the coefficients, results in the system of equations  $18A + 6B + 2C = 0$ ,  $18B + 12C = 0$ , and  $18C = 1$ . Hence

$$Y_2 = \frac{1}{162} e^{3t} - \frac{1}{27} t e^{3t} + \frac{1}{18} t^2 e^{3t}.$$

The general solution is  $y(t) = y_c(t) + Y_1 + Y_2$ .

7. The characteristic equation for the homogeneous problem is  $2r^2 + 3r + 1 = 0$ , with roots  $r = -1, -1/2$ . Hence  $y_c(t) = c_1 e^{-t} + c_2 e^{-t/2}$ . To simplify the analysis, set  $g_1(t) = t^2$  and  $g_2(t) = 3 \sin t$ . Based on the form of  $g_1$ , set  $Y_1 = A + Bt + Ct^2$ . Substitution into the differential equation, and comparing the coefficients, results in the system of equations  $A + 3B + 4C = 0$ ,  $B + 6C = 0$ , and  $C = 1$ . Hence we obtain  $Y_1 = 14 - 6t + t^2$ . On the other hand, set  $Y_2 = D \cos t + E \sin t$ . After substitution into the ODE, we find that  $D = -9/10$  and  $E = -3/10$ . The general solution is  $y(t) = y_c(t) + Y_1 + Y_2$ .

9. The characteristic equation for the homogeneous problem is  $r^2 + \omega_0^2 = 0$ , with complex roots  $r = \pm \omega_0 i$ . Hence  $y_c(t) = c_1 \cos \omega_0 t + c_2 \sin \omega_0 t$ . Since  $\omega \neq \omega_0$ , set  $Y = A \cos \omega t + B \sin \omega t$ . Substitution into the ODE and comparing the coefficients results in the system of equations  $(\omega_0^2 - \omega^2)A = 1$  and  $(\omega_0^2 - \omega^2)B = 0$ . Hence

$$Y = \frac{1}{\omega_0^2 - \omega^2} \cos \omega t.$$

The general solution is  $y(t) = y_c(t) + Y$ .



10. From Prob. 9,  $y_c(t) = c$ . Since  $\cos \omega_0 t$  is a solution of the homogeneous problem, set  $Y = At \cos \omega_0 t + Bt \sin \omega_0 t$ . Substitution into the given ODE and comparing the coefficients results in  $A = 0$  and  $B = \frac{1}{2\omega_0}$ . Hence the general solution is

$$y(t) = c_1 \cos \omega_0 t + c_2 \sin \omega_0 t + \frac{t}{2\omega_0} \sin \omega_0 t.$$

12. The characteristic equation for the homogeneous problem is  $r^2 - r - 2 = 0$ , with roots  $r = -1, 2$ . Hence  $y_c(t) = c_1 e^{-t} + c_2 e^{2t}$ . Based on the form of the right hand side, that is,  $\cosh(2t) = (e^{2t} + e^{-2t})/2$ , set  $Y = At e^{2t} + B e^{-2t}$ . Substitution into the given ODE and comparing the coefficients results in  $A = 1/6$  and  $B = 1/8$ . Hence the general solution is  $y(t) = c_1 e^{-t} + c_2 e^{2t} + t e^{2t}/6 + e^{-2t}/8$ .

14. The characteristic equation for the homogeneous problem is  $r^2 + 4 = 0$ , with roots  $r = \pm 2i$ . Hence  $y_c(t) = c_1 \cos 2t + c_2 \sin 2t$ . Set  $Y_1 = A + Bt + Ct^2$ . Comparing the coefficients of the respective terms, we find that  $A = -1/8, B = 0, C = 1/4$ . Now set  $Y_2 = D e^t$ , and obtain  $D = 3/5$ . Hence the general solution is

$$y(t) = c_1 \cos 2t + c_2 \sin 2t - 1/8 + t^2/4 + 3 e^t/5.$$

Invoking the initial conditions, we require that  $19/40 + c_1 = 0$  and  $3/5 + 2c_2 = 2$ . Hence  $c_1 = -19/40$  and  $c_2 = 7/10$ .

15. The characteristic equation for the homogeneous problem is  $r^2 - 2r + 1 = 0$ , with a double root  $r = 1$ . Hence  $y_c(t) = c_1 e^t + c_2 t e^t$ . Consider  $g_1(t) = t e^t$ . Note that  $g_1$  is a solution of the homogeneous problem. Set  $Y_1 = At^2 e^t + Bt^3 e^t$  (the *first* term is not sufficient for a match). Upon substitution, we obtain  $Y_1 = t^3 e^t/6$ . By inspection,  $Y_2 = 4$ . Hence the general solution is  $y(t) = c_1 e^t + c_2 t e^t + t^3 e^t/6 + 4$ . Invoking the initial conditions, we require that  $c_1 + 4 = 1$  and  $c_1 + c_2 = 1$ . Hence  $c_1 = -3$  and  $c_2 = 4$ .

17. The characteristic equation for the homogeneous problem is  $r^2 + 4 = 0$ , with roots  $r = \pm 2i$ . Hence  $y_c(t) = c_1 \cos 2t + c_2 \sin 2t$ . Since the function  $\sin 2t$  is a solution of the homogeneous problem, set  $Y = At \cos 2t + Bt \sin 2t$ . Upon substitution, we obtain  $Y = -\frac{3}{4}t \cos 2t$ . Hence the general solution is  $y(t) = c_1 \cos 2t + c_2 \sin 2t - \frac{1}{4}t \cos 2t$ . Invoking the initial conditions, we require that  $c_1 = 2$  and  $2c_2 - \frac{3}{4} = -1$ . Hence  $c_1 = 2$  and  $c_2 = -1/8$ .

18. The characteristic equation for the homogeneous problem is  $r^2 + 2r + 5 = 0$ , with complex roots  $r = -1 \pm 2i$ . Hence  $y_c(t) = c_1 e^{-t} \cos 2t + c_2 e^{-t} \sin 2t$ . Based on the form of  $g(t)$ , set  $Y = At e^{-t} \cos 2t + Bt e^{-t} \sin 2t$ . After comparing coefficients, we obtain  $Y = t e^{-t} \sin 2t$ . Hence the general solution is

$$y(t) = c_1 e^{-t} \cos 2t + c_2 e^{-t} \sin 2t + t e^{-t} \sin 2t.$$

Invoking the initial conditions, we require that  $c_1 = 1$  and  $-c_1 + 2c_2 = 0$ . Hence  $c_1 = 1$  and  $c_2 = 1/2$ .

20. The characteristic equation for the homogeneous problem is  $r^2 + 1 = 0$ , with complex roots  $r = \pm i$ . Hence  $y_c(t) = c_1 \cos t + c_2 \sin t$ . Let  $g_1(t) = t \sin t$  and  $g_2(t) = t$ . By inspection, it is easy to see that  $Y_2(t) = 1$ . Based on the form of  $g_1(t)$ , set  $Y_1(t) = At \cos t + Bt \sin t + Ct^2 \cos t + Dt^2 \sin t$ . Substitution into the equation and comparing the coefficients results in  $A = 0$ ,  $B = 1/4$ ,  $C = -1/4$ , and  $D = 0$ . Hence  $Y(t) = 1 + \frac{1}{4}t \sin t - \frac{1}{4}t^2 \cos t$ .

21. The characteristic equation for the homogeneous problem is  $r^2 - 5r + 6 = 0$ , with roots  $r = 2, 3$ . Hence  $y_c(t) = c_1 e^{2t} + c_2 e^{3t}$ . Consider  $g_1(t) = e^{2t}(3t + 4) \sin t$ , and  $g_2(t) = e^t \cos 2t$ . Based on the form of these functions on the right hand side of the ODE,

set  $Y_2(t) = e^t(A_1 \cos 2t + A_2 \sin 2t)$ ,  $Y_1(t) = (B_1 + B_2 t)e^{2t} \sin t + (C_1 + C_2 t)e^{2t} \cos t$ . Substitution into the equation and comparing the coefficients results in

$$Y(t) = -\frac{1}{20}(e^t \cos 2t + 3e^t \sin 2t) + \frac{3}{2}te^{2t}(\cos t - \sin t) + e^{2t}\left(\frac{1}{2}\cos t - 5\sin t\right).$$

23. The characteristic roots are  $r = 2, 2$ . Hence  $y_c(t) = c_1 e^{2t} + c_2 t e^{2t}$ . Consider the functions  $g_1(t) = 2t^2$ ,  $g_2(t) = 4te^{2t}$ , and  $g_3(t) = t \sin 2t$ . The corresponding forms of the respective parts of the particular solution are  $Y_1(t) = A_0 + A_1 t + A_2 t^2$ ,  $Y_2(t) = e^{2t}(B_2 t^2 + B_3 t^3)$ , and  $Y_3(t) = t(C_1 \cos 2t + C_2 \sin 2t) + (D_1 \cos 2t + D_2 \sin 2t)$ . Substitution into the equation and comparing the coefficients results in

$$Y(t) = \frac{1}{4}(3 + 4t + 2t^2) + \frac{2}{3}t^3 e^{2t} + \frac{1}{8}t \cos 2t + \frac{1}{16}(\cos 2t - \sin 2t).$$

24. The homogeneous solution is  $y_c(t) = c_1 \cos 2t + c_2 \sin 2t$ . Since  $\cos 2t$  and  $\sin 2t$  are both solutions of the homogeneous equation, set

$$Y(t) = t(A_0 + A_1 t + A_2 t^2) \cos 2t + t(B_0 + B_1 t + B_2 t^2) \sin 2t.$$

Substitution into the equation and comparing the coefficients results in

$$Y(t) = \left(\frac{13}{32}t - \frac{1}{12}t^3\right) \cos 2t + \frac{1}{16}(28t + 13t^2) \sin 2t.$$

25. The homogeneous solution is  $y_c(t) = c_1 e^{-t} + c_2 t e^{-2t}$ . None of the functions on the right hand side are solutions of the homogenous equation. In order to include all possible combinations of the derivatives, consider  $Y(t) = e^t(A_0 + A_1 t + A_2 t^2) \cos 2t + e^t(B_0 + B_1 t + B_2 t^2) \sin 2t + e^{-t}(C_1 \cos t + C_2 \sin t) + D e^t$ . Substitution into the differential equation and comparing the coefficients results in

$$Y(t) = e^t(A_0 + A_1 t + A_2 t^2) \cos 2t + e^t(B_0 + B_1 t + B_2 t^2) \sin 2t + e^{-t}\left(-\frac{2}{3} \cos t + \frac{2}{3} \sin t\right) + 2e^t/3,$$

in which  $A_0 = -4105/35152$ ,  $A_1 = 73/676$ ,  $A_2 = -5/52$ ,  $B_0 = -1233/35152$ ,  $B_1 = 10/169$ ,  $B_2 = 1/52$ .

26. The homogeneous solution is  $y_c(t) = c_1 e^{-t} \cos 2t + c_2 e^{-t} \sin 2t$ . None of the terms on the right hand side are solutions of the homogenous equation. In order to include the appropriate combinations of derivatives, consider  $Y(t) = e^{-t}(A_1 t + A_2 t^2) \cos 2t + e^{-t}(B_1 t + B_2 t^2) \sin 2t + e^{-2t}(C_0 + C_1 t) \cos 2t + e^{-2t}(D_0 + D_1 t) \sin 2t$ . Substitution into the differential equation and comparing the coefficients results in

$$Y(t) = \frac{3}{16} t e^{-t} \cos 2t + \frac{3}{8} t^2 e^{-t} \sin 2t - \frac{1}{25} e^{-2t} (7 + 10t) \cos 2t + \frac{1}{25} e^{-2t} (1 + 5t) \sin 2t.$$

27. The homogeneous solution is  $y_c(t) = c_1 \cos \lambda t + c_2 \sin \lambda t$ . Since the differential operator does not contain a *first derivative* (and  $\lambda \neq m\pi$ ), we can set

$$Y(t) = \sum_{m=1}^N C_m \sin m\pi t.$$

Substitution into the ODE yields

$$-\sum_{m=1}^N m^2 \pi^2 C_m \sin m\pi t + \lambda^2 \sum_{m=1}^N C_m \sin m\pi t = \sum_{m=1}^N a_m \sin m\pi t.$$

Equating coefficients of the individual terms, we obtain

$$C_m = \frac{a_m}{\lambda^2 - m^2 \pi^2}, \quad m = 1, 2 \dots N.$$

29. The homogeneous solution is  $y_c(t) = c_1 e^{-t} \cos 2t + c_2 e^{-t} \sin 2t$ . The input function is *independent* of the homogeneous solutions, on any interval. Since the right hand side is *piecewise constant*, it follows by inspection that

$$Y(t) = \begin{cases} 1/5, & 0 \leq t \leq \pi/2 \\ 0, & t > \pi/2 \end{cases}.$$

For  $0 \leq t \leq \pi/2$ , the general solution is  $y(t) = c_1 e^{-t} \cos 2t + c_2 e^{-t} \sin 2t + 1/5$ . Invoking the initial conditions  $y(0) = y'(0) = 0$ , we require that  $c_1 = -1/5$ , and that  $c_2 = -1/10$ . Hence

$$y(t) = \frac{1}{5} - \frac{1}{10} (2e^{-t} \cos 2t + e^{-t} \sin 2t)$$

on the interval  $0 \leq t \leq \pi/2$ . We now have the values  $y(\pi/2) = (1 + e^{-\pi/2})/5$ , and  $y'(\pi/2) = 0$ . For  $t > \pi/2$ , the general solution is  $y(t) = d_1 e^{-t} \cos 2t + d_2 e^{-t} \sin 2t$ . It follows that  $y(\pi/2) = -e^{-\pi/2} d_1$  and  $y'(\pi/2) = e^{-\pi/2} d_1 - 2e^{-\pi/2} d_2$ . Since the

solution is continuously differentiable, we require that

$$\begin{aligned} -e^{-\pi/2}d_1 &= (1 + e^{-\pi/2})/5 \\ e^{-\pi/2}d_1 - 2e^{-\pi/2}d_2 &= 0. \end{aligned}$$

Solving for the coefficients,  $d_1 = 2d_2 = -(e^{\pi/2} + 1)/5$ .

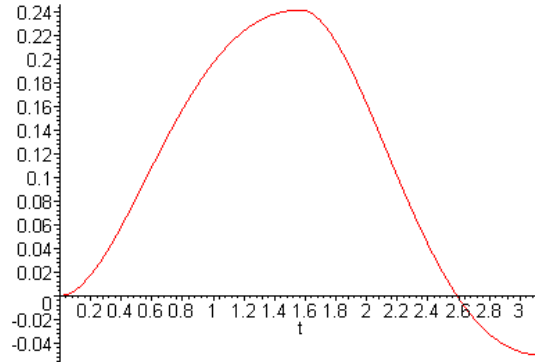

31. Since  $a, b, c > 0$ , the roots of the characteristic equation has *negative* real parts. That is,  $r = \alpha \pm \beta i$ , where  $\alpha < 0$ . Hence the homogeneous solution is

$$y_c(t) = c_1 e^{\alpha t} \cos \beta t + c_2 e^{\alpha t} \sin \beta t.$$

If  $g(t) = d$ , then the general solution is

$$y(t) = d/c + c_1 e^{\alpha t} \cos \beta t + c_2 e^{\alpha t} \sin \beta t.$$

Since  $\alpha < 0$ ,  $y(t) \rightarrow d/c$  as  $t \rightarrow \infty$ . If  $c = 0$ , then that characteristic roots are  $r = 0$  and  $r = -b/a$ . The ODE becomes  $ay'' + by' = d$ . Integrating both sides, we find that  $ay' + by = dt + c_1$ . The general solution can be expressed as

$$y(t) = dt/b + c_1 + c_2 e^{-bt/a}.$$

In this case, the solution grows without bound. If  $b = 0$ , *also*, then the differential equation

can be written as  $y'' = d/a$ , which has general solution  $y(t) = d t^2/2a + c_1 + c_2$ .

Hence the assertion is true only if the coefficients are *positive*.

32(a). Since  $D$  is a linear operator,

$$\begin{aligned} D^2 y + bDy + cy &= D^2 y - (r_1 + r_2)Dy + r_1 r_2 y \\ &= D^2 y - r_2 Dy - r_1 Dy + r_1 r_2 y \\ &= D(Dy - r_2 y) - r_1(Dy - r_2 y) \\ &= (D - r_1)(D - r_2)y. \end{aligned}$$

(b). Let  $u = (D - r_2)y$ . Then the ODE (i) can be written as  $(D - r_1)u = g(t)$ , that is,

$u' - r_1 u = g(t)$ . The latter is a linear *first order* equation in  $u$ . Its general solution is

$$u(t) = e^{r_1 t} \int_{t_0}^t e^{-r_1 \tau} g(\tau) d\tau + c_1 e^{r_1 t}.$$

From above, we have  $y' - r_2 y = u(t)$ . This equation is also a first order ODE. Hence the general solution of the original second order equation is

$$y(t) = e^{r_2 t} \int_{t_0}^t e^{-r_2 \tau} u(\tau) d\tau + c_2 e^{r_2 t}.$$

Note that the solution  $y(t)$  contains *two* arbitrary constants.

34. Note that  $(2D^2 + 3D + 1)y = (2D + 1)(D + 1)y$ . Let  $u = (D + 1)y$ , and solve the ODE  $2u' + u = t^2 + 3\sin t$ . This equation is a linear first order ODE, with solution

$$\begin{aligned} u(t) &= e^{-t/2} \int_{t_0}^t e^{\tau/2} \left[ \tau^2/2 + \frac{3}{2} \sin \tau \right] d\tau + c e^{-t/2} \\ &= t^2 - 4t + 8 - \frac{6}{5} \cos t + \frac{3}{5} \sin t + c e^{-t/2}. \end{aligned}$$

Now consider the ODE  $y' + y = u(t)$ . The general solution of this first order ODE is

$$y(t) = e^{-t} \int_{t_0}^t e^{\tau} u(\tau) d\tau + c_2 e^{-t},$$

in which  $u(t)$  is given above. Substituting for  $u(t)$  and performing the integration,

$$y(t) = t^2 - 6t + 14 - \frac{9}{10} \cos t - \frac{3}{10} \sin t + c_1 e^{-t/2} + c_2 e^{-t}.$$

35. We have  $(D^2 + 2D + 1)y = (D + 1)(D + 1)y$ . Let  $u = (D + 1)y$ , and consider the ODE  $u' + u = 2e^{-t}$ . The general solution is  $u(t) = 2te^{-t} + ce^{-t}$ . We therefore have the first order equation  $u' + u = 2te^{-t} + c_1 e^{-t}$ . The general solution of the latter differential equation is

$$\begin{aligned} y(t) &= e^{-t} \int_{t_0}^t [2\tau + c_1] d\tau + c_2 e^{-t} \\ &= e^{-t} (t^2 + c_1 t + c_2). \end{aligned}$$

36. We have  $(D^2 + 2D)y = D(D + 2)y$ . Let  $u = (D + 2)y$ , and consider the equation  $u' = 3 + 4\sin 2t$ . Direct integration results in  $u(t) = 3t - 2\cos 2t + c$ . The problem is reduced to solving the ODE  $y' + 2y = 3t - 2\cos 2t + c$ . The general solution of this first order differential equation is

$$\begin{aligned}y(t) &= e^{-2t} \int_{t_0}^t e^{2\tau} [3\tau - 2\cos 2\tau + c] d\tau + c_2 e^{-2t} \\ &= \frac{3}{2}t - \frac{1}{2}(\cos 2t + \sin 2t) + c_1 + c_2 e^{-2t}.\end{aligned}$$

## Section 3.7

1. The solution of the homogeneous equation is  $y_c(t) = c_1e^{2t} + c_2e^{3t}$ . The functions  $y_1(t) = e^{2t}$  and  $y_2(t) = e^{3t}$  form a fundamental set of solutions. The Wronskian of these functions is  $W(y_1, y_2) = e^{5t}$ . Using the method of *variation of parameters*, the particular solution is given by  $Y(t) = u_1(t)y_1(t) + u_2(t)y_2(t)$ , in which

$$\begin{aligned} u_1(t) &= - \int \frac{e^{3t}(2e^t)}{W(t)} dt \\ &= 2e^{-t} \end{aligned}$$

$$\begin{aligned} u_2(t) &= \int \frac{e^{2t}(2e^t)}{W(t)} dt \\ &= -e^{-2t} \end{aligned}$$

Hence the particular solution is  $Y(t) = 2e^t - e^t = e^t$ .

3. The solution of the homogeneous equation is  $y_c(t) = c_1e^{-t} + c_2te^{-t}$ . The functions  $y_1(t) = e^{-t}$  and  $y_2(t) = te^{-t}$  form a fundamental set of solutions. The Wronskian of these functions is  $W(y_1, y_2) = e^{-2t}$ . Using the method of *variation of parameters*, the particular solution is given by  $Y(t) = u_1(t)y_1(t) + u_2(t)y_2(t)$ , in which

$$\begin{aligned} u_1(t) &= - \int \frac{te^{-t}(3e^{-t})}{W(t)} dt \\ &= -3t^2/2 \end{aligned}$$

$$\begin{aligned} u_2(t) &= \int \frac{e^{-t}(3e^{-t})}{W(t)} dt \\ &= 3t \end{aligned}$$

Hence the particular solution is  $Y(t) = -3t^2e^{-t}/2 + 3te^{-t} = 3t^2e^{-t}/2$ .

4. The functions  $y_1(t) = e^{t/2}$  and  $y_2(t) = te^{t/2}$  form a fundamental set of solutions. The Wronskian of these functions is  $W(y_1, y_2) = e^t$ . First write the equation in standard form, so that  $g(t) = 4e^{t/2}$ . Using the method of *variation of parameters*, the particular solution is given by  $Y(t) = u_1(t)y_1(t) + u_2(t)y_2(t)$ , in which

$$\begin{aligned} u_1(t) &= - \int \frac{te^{t/2}(4e^{t/2})}{W(t)} dt \\ &= -2t^2 \end{aligned}$$

$$\begin{aligned} u_2(t) &= \int \frac{e^{t/2}(4e^{t/2})}{W(t)} dt \\ &= 4t \end{aligned}$$

Hence the particular solution is  $Y(t) = -2t^2e^{t/2} + 4t^2e^{t/2} = 2t^2e^{t/2}$ .

6. The solution of the homogeneous equation is  $y_c(t) = c_1 \cos 3t + c_2 \sin 3t$ . The two functions  $y_1(t) = \cos 3t$  and  $y_2(t) = \sin 3t$  form a fundamental set of solutions, with  $W(y_1, y_2) = 3$ . The particular solution is given by  $Y(t) = u_1(t)y_1(t) + u_2(t)y_2(t)$ , in which

$$\begin{aligned} u_1(t) &= - \int \frac{\sin 3t(9 \sec^2 3t)}{W(t)} dt \\ &= - \csc 3t \end{aligned}$$

$$\begin{aligned} u_2(t) &= \int \frac{\cos 3t(9 \sec^2 3t)}{W(t)} dt \\ &= \ln|\sec 3t + \tan 3t| \end{aligned}$$

Hence the particular solution is  $Y(t) = -1 + (\sin 3t)\ln|\sec 3t + \tan 3t|$ . The general solution is given by  $y(t) = c_1 \cos 3t + c_2 \sin 3t + (\sin 3t)\ln|\sec 3t + \tan 3t| - 1$ .

7. The functions  $y_1(t) = e^{-2t}$  and  $y_2(t) = te^{-2t}$  form a fundamental set of solutions. The Wronskian of these functions is  $W(y_1, y_2) = e^{-4t}$ . The particular solution is given by  $Y(t) = u_1(t)y_1(t) + u_2(t)y_2(t)$ , in which

$$\begin{aligned} u_1(t) &= - \int \frac{te^{-2t}(t^{-2}e^{-2t})}{W(t)} dt \\ &= - \ln t \end{aligned}$$

$$\begin{aligned} u_2(t) &= \int \frac{e^{-2t}(t^{-2}e^{-2t})}{W(t)} dt \\ &= -1/t \end{aligned}$$

Hence the particular solution is  $Y(t) = -e^{-2t} \ln t - e^{-2t}$ . Since the *second term* is a solution of the homogeneous equation, the general solution is given by  $y(t) = c_1 e^{-2t} + c_2 t e^{-2t} - e^{-2t} \ln t$ .

8. The solution of the homogeneous equation is  $y_c(t) = c_1 \cos 2t + c_2 \sin 2t$ . The two functions  $y_1(t) = \cos 2t$  and  $y_2(t) = \sin 2t$  form a fundamental set of solutions, with  $W(y_1, y_2) = 2$ . The particular solution is given by  $Y(t) = u_1(t)y_1(t) + u_2(t)y_2(t)$ , in which



$$\begin{aligned} u_1(t) &= - \int \frac{\sin 2t(3 \csc 2t)}{W(t)} dt \\ &= - 3t/2 \end{aligned}$$

$$\begin{aligned} u_2(t) &= \int \frac{\cos 2t(3 \csc 2t)}{W(t)} dt \\ &= \frac{3}{4} \ln |\sin 2t| \end{aligned}$$

Hence the particular solution is  $Y(t) = -\frac{3}{2}t \cos 2t + \frac{3}{4}(\sin 3t) \ln |\sin 2t|$ . The general solution is given by  $y(t) = c_1 \cos 2t + c_2 \sin 2t - \frac{3}{2}t \cos 2t + \frac{3}{4}(\sin 3t) \ln |\sin 2t|$ .

9. The functions  $y_1(t) = \cos(t/2)$  and  $y_2(t) = \sin(t/2)$  form a fundamental set of solutions. The Wronskian of these functions is  $W(y_1, y_2) = 1/2$ . First write the ODE in standard form, so that  $g(t) = \sec(t/2)/2$ . The particular solution is given by  $Y(t) = u_1(t)y_1(t) + u_2(t)y_2(t)$ , in which

$$\begin{aligned} u_1(t) &= - \int \frac{\cos(t/2)[\sec(t/2)]}{2W(t)} dt \\ &= 2 \ln[\cos(t/2)] \end{aligned}$$

$$\begin{aligned} u_2(t) &= \int \frac{\sin(t/2)[\sec(t/2)]}{2W(t)} dt \\ &= t \end{aligned}$$

The particular solution is  $Y(t) = 2\cos(t/2)\ln[\cos(t/2)] + t \sin(t/2)$ . The general solution is given by

$$y(t) = c_1 \cos(t/2) + c_2 \sin(t/2) + 2 \cos(t/2) \ln[\cos(t/2)] + t \sin(t/2).$$

10. The solution of the homogeneous equation is  $y_c(t) = c_1 e^t + c_2 t e^t$ . The functions  $y_1(t) = e^t$  and  $y_2(t) = t e^t$  form a fundamental set of solutions, with  $W(y_1, y_2) = e^{2t}$ . The particular solution is given by  $Y(t) = u_1(t)y_1(t) + u_2(t)y_2(t)$ , in which

$$\begin{aligned} u_1(t) &= - \int \frac{t e^t (e^t)}{W(t)(1+t^2)} dt \\ &= - \frac{1}{2} \ln(1+t^2) \end{aligned}$$

$$\begin{aligned} u_2(t) &= \int \frac{e^t (e^t)}{W(t)(1+t^2)} dt \\ &= \arctan t \end{aligned}$$

The particular solution is  $Y(t) = -\frac{1}{2}e^t \ln(1+t^2) + t e^t \arctan(t)$ . Hence the general

solution is given by  $y(t) = c_1 e^t + c_2 t e^t - \frac{1}{2} e^t \ln(1+t^2) + t e^t \arctan(t)$ .

12. The functions  $y_1(t) = \cos 2t$  and  $y_2(t) = \sin 2t$  form a fundamental set of solutions, with  $W(y_1, y_2) = 2$ . The particular solution is given by  $Y(t) = u_1(t)y_1(t) + u_2(t)y_2(t)$ , in which

$$u_1(t) = -\frac{1}{2} \int^t g(s) \sin 2s \, ds$$

$$u_2(t) = \frac{1}{2} \int^t g(s) \cos 2s \, ds$$

Hence the particular solution is

$$Y(t) = -\frac{1}{2} \cos 2t \int^t g(s) \sin 2s \, ds + \frac{1}{2} \sin 2t \int^t g(s) \cos 2s \, ds.$$

Note that  $\sin 2t \cos 2s - \cos 2t \sin 2s = \sin(2t - 2s)$ . It follows that

$$Y(t) = \frac{1}{2} \int^t g(s) \sin(2t - 2s) \, ds.$$

The general solution of the differential equation is given by

$$y(t) = c_1 \cos 2t + c_2 \sin 2t + \frac{1}{2} \int^t g(s) \sin(2t - 2s) \, ds.$$

13. Note first that  $p(t) = 0$ ,  $q(t) = -2/t^2$  and  $g(t) = (3t^2 - 1)/t^2$ . The functions  $y_1(t)$  and  $y_2(t)$  are solutions of the homogeneous equation, verified by substitution. The Wronskian of these two functions is  $W(y_1, y_2) = -3$ . Using the method of *variation of parameters*, the particular solution is  $Y(t) = u_1(t)y_1(t) + u_2(t)y_2(t)$ , in which

$$\begin{aligned} u_1(t) &= -\int \frac{t^{-1}(3t^2 - 1)}{t^2 W(t)} dt \\ &= t^{-2}/6 + \ln t \end{aligned}$$

$$\begin{aligned} u_2(t) &= \int \frac{t^2(3t^2 - 1)}{t^2 W(t)} dt \\ &= -t^3/3 + t/3 \end{aligned}$$

Therefore  $Y(t) = 1/6 + t^2 \ln t - t^2/3 + 1/3$ . Hence the general solution is

$$y(t) = c_1 t^2 + c_2 t^{-1} + t^2 \ln t + 1/2.$$

15. Observe that  $g(t) = t e^{2t}$ . The functions  $y_1(t)$  and  $y_2(t)$  are a fundamental set of solutions. The Wronskian of these two functions is  $W(y_1, y_2) = t e^t$ . Using the method of *variation of parameters*, the particular solution is  $Y(t) = u_1(t) y_1(t) + u_2(t) y_2(t)$ , in which

$$\begin{aligned} u_1(t) &= - \int \frac{e^t (t e^{2t})}{W(t)} dt \\ &= - e^{2t} / 2 \end{aligned}$$

$$\begin{aligned} u_2(t) &= \int \frac{(1+t)(t e^{2t})}{W(t)} dt \\ &= t e^t \end{aligned}$$

Therefore  $Y(t) = -(1+t)e^{2t}/2 + t e^{2t} = -e^{2t}/2 + t e^{2t}/2$ .

16. Observe that  $g(t) = 2(1-t)e^{-t}$ . Direct substitution of  $y_1(t) = e^t$  and  $y_2(t) = t$  verifies that they are solutions of the homogeneous equation. The Wronskian of the two solutions is  $W(y_1, y_2) = (1-t)e^t$ . Using the method of *variation of parameters*, the particular solution is  $Y(t) = u_1(t) y_1(t) + u_2(t) y_2(t)$ , in which

$$\begin{aligned} u_1(t) &= - \int \frac{2t(1-t)e^{-t}}{W(t)} dt \\ &= t e^{-2t} + e^{-2t} / 2 \end{aligned}$$

$$\begin{aligned} u_2(t) &= \int \frac{2(1-t)}{W(t)} dt \\ &= -2e^{-t} \end{aligned}$$

Therefore  $Y(t) = t e^{-t} + e^{-t} / 2 - 2t e^{-t} = -t e^{-t} + e^{-t} / 2$ .

17. Note that  $g(x) = \ln x$ . The functions  $y_1(x) = x^2$  and  $y_2(x) = x^2 \ln x$  are solutions of the homogeneous equation, as verified by substitution. The Wronskian of the solutions is  $W(y_1, y_2) = x^3$ . Using the method of *variation of parameters*, the particular solution is

$$Y(x) = u_1(x) y_1(x) + u_2(x) y_2(x),$$

in which

$$\begin{aligned} u_1(x) &= - \int \frac{x^2 \ln x (\ln x)}{W(x)} dx \\ &= - (\ln x)^3 / 3 \end{aligned}$$

$$\begin{aligned} u_2(x) &= \int \frac{x^2(\ln x)}{W(x)} dx \\ &= (\ln x)^2/2 \end{aligned}$$

Therefore  $Y(x) = -x^2(\ln x)^3/3 + x^2(\ln x)^3/2 = x^2(\ln x)^3/6$ .

19. First write the equation in *standard form*. Note that the forcing function becomes  $g(x)/(1-x)$ . The functions  $y_1(x) = e^x$  and  $y_2(x) = x$  are a fundamental set of solutions,

as verified by substitution. The Wronskian of the solutions is  $W(y_1, y_2) = (1-x)e^x$ .

Using the method of *variation of parameters*, the particular solution is

$$Y(x) = u_1(x) y_1(x) + u_2(x) y_2(x),$$

in which

$$u_1(x) = - \int \frac{\tau(g(\tau))}{(1-\tau)W(\tau)} d\tau$$

$$u_2(x) = \int \frac{e^\tau(g(\tau))}{(1-\tau)W(\tau)} d\tau$$

Therefore

$$\begin{aligned} Y(x) &= -e^x \int \frac{\tau(g(\tau))}{(1-\tau)W(\tau)} d\tau + x \int \frac{e^\tau(g(\tau))}{(1-\tau)W(\tau)} d\tau \\ &= \int \frac{(xe^\tau - e^x\tau)g(\tau)}{(1-\tau)^2 e^\tau} d\tau. \end{aligned}$$

20. First write the equation in *standard form*. The forcing function becomes  $g(x)/x^2$ . The functions  $y_1(x) = x^{-1/2}\sin x$  and  $y_2(x) = x^{-1/2}\cos x$  are a fundamental set of solutions. The Wronskian of the solutions is  $W(y_1, y_2) = -1/x$ . Using the method of *variation of parameters*, the particular solution is

$$Y(x) = u_1(x) y_1(x) + u_2(x) y_2(x),$$

in which

$$u_1(x) = \int \frac{\cos \tau (g(\tau))}{\tau \sqrt{\tau}} d\tau$$

$$u_2(x) = - \int \frac{\sin \tau (g(\tau))}{\tau \sqrt{\tau}} d\tau$$

Therefore

$$\begin{aligned}
 Y(x) &= \frac{\sin x}{\sqrt{x}} \int^x \frac{\cos \tau (g(\tau))}{\tau \sqrt{\tau}} d\tau - \frac{\cos x}{\sqrt{x}} \int^x \frac{\sin \tau (g(\tau))}{\tau \sqrt{\tau}} d\tau \\
 &= \frac{1}{\sqrt{x}} \int^x \frac{\sin(x - \tau) g(\tau)}{\tau \sqrt{\tau}} d\tau.
 \end{aligned}$$

21. Let  $y_1(t)$  and  $y_2(t)$  be a fundamental set of solutions, and  $W(t) = W(y_1, y_2)$  be the corresponding Wronskian. Any solution,  $u(t)$ , of the homogeneous equation is a linear combination  $u(t) = \alpha_1 y_1(t) + \alpha_2 y_2(t)$ . Invoking the initial conditions, we require that

$$\begin{aligned}
 y_0 &= \alpha_1 y_1(t_0) + \alpha_2 y_2(t_0) \\
 y'_0 &= \alpha_1 y'_1(t_0) + \alpha_2 y'_2(t_0)
 \end{aligned}$$

Note that this system of equations has a unique solution, since  $W(t_0) \neq 0$ . Now consider the *nonhomogeneous* problem,  $L[v] = g(t)$ , with *homogeneous* initial conditions. Using the method of variation of parameters, the particular solution is given by

$$Y(t) = -y_1(t) \int_{t_0}^t \frac{y_2(s) g(s)}{W(s)} ds + y_2(t) \int_{t_0}^t \frac{y_1(s) g(s)}{W(s)} ds.$$

The general solution of the IVP (iii) is

$$\begin{aligned}
 v(t) &= \beta_1 y_1(t) + \beta_2 y_2(t) + Y(t) \\
 &= \beta_1 y_1(t) + \beta_2 y_2(t) + y_1(t) u_1(t) + y_2(t) u_2(t)
 \end{aligned}$$

in which  $u_1$  and  $u_2$  are defined above. Invoking the initial conditions, we require that

$$\begin{aligned}
 0 &= \beta_1 y_1(t_0) + \beta_2 y_2(t_0) + Y(t_0) \\
 0 &= \beta_1 y'_1(t_0) + \beta_2 y'_2(t_0) + Y'(t_0)
 \end{aligned}$$

Based on the definition of  $u_1$  and  $u_2$ ,  $Y(t_0) = 0$ . Furthermore, since  $y_1 u'_1 + y_2 u'_2 = 0$ , it follows that  $Y'(t_0) = 0$ . Hence the only solution of the above system of equations is the *trivial solution*. Therefore  $v(t) = Y(t)$ . Now consider the function  $y = u + v$ . Then  $L[y] = L[u + v] = L[u] + L[v] = g(t)$ . That is,  $y(t)$  is a solution of the nonhomogeneous

problem. Further,  $y(t_0) = u(t_0) + v(t_0) = y_0$ , and similarly,  $y'(t_0) = y'_0$ . By the uniqueness theorems,  $y(t)$  is the unique solution of the initial value problem.

23. A fundamental set of solutions is  $y_1(t) = \cos t$  and  $y_2(t) = \sin t$ . The Wronskian  $W(t) = y_1 y'_2 - y'_1 y_2 = 1$ . By the result in Prob. 22,

$$\begin{aligned}
 Y(t) &= \int_{t_0}^t \frac{\cos(s) \sin(t) - \cos(t) \sin(s)}{W(s)} g(s) ds \\
 &= \int_{t_0}^t [\cos(s) \sin(t) - \cos(t) \sin(s)] g(s) ds.
 \end{aligned}$$

Finally, we have  $\cos(s) \sin(t) - \cos(t) \sin(s) = \sin(t - s)$ .

24. A fundamental set of solutions is  $y_1(t) = e^{at}$  and  $y_2(t) = e^{bt}$ . The Wronskian  $W(t) = y_1 y_2' - y_1' y_2 = (b - a) \exp[(a + b)t]$ . By the result in Prob. 22,

$$\begin{aligned} Y(t) &= \int_{t_0}^t \frac{e^{as} e^{bt} - e^{at} e^{bs}}{W(s)} g(s) ds \\ &= \frac{1}{b - a} \int_{t_0}^t \frac{e^{as} e^{bt} - e^{at} e^{bs}}{\exp[(a + b)s]} g(s) ds. \end{aligned}$$

Hence the particular solution is

$$Y(t) = \frac{1}{b - a} \int_{t_0}^t [e^{b(t-s)} - e^{a(t-s)}] g(s) ds.$$

26. A fundamental set of solutions is  $y_1(t) = e^{at}$  and  $y_2(t) = te^{at}$ . The Wronskian  $W(t) = y_1 y_2' - y_1' y_2 = e^{2at}$ . By the result in Prob. 22,

$$\begin{aligned} Y(t) &= \int_{t_0}^t \frac{e^{as} e^{bt} - e^{at} e^{bs}}{W(s)} g(s) ds \\ &= \frac{1}{b - a} \int_{t_0}^t \frac{e^{as} e^{bt} - e^{at} e^{bs}}{\exp[(a + b)s]} g(s) ds. \end{aligned}$$

Hence the particular solution is

$$Y(t) = \frac{1}{b - a} \int_{t_0}^t [e^{b(t-s)} - e^{a(t-s)}] g(s) ds.$$

26. A fundamental set of solutions is  $y_1(t) = e^{at}$  and  $y_2(t) = te^{at}$ . The Wronskian  $W(t) = y_1 y_2' - y_1' y_2 = e^{2at}$ . By the result in Prob. 22,

$$\begin{aligned} Y(t) &= \int_{t_0}^t \frac{te^{as+at} - se^{at+as}}{W(s)} g(s) ds \\ &= \int_{t_0}^t \frac{(t - s)e^{as+at}}{e^{2as}} g(s) ds. \end{aligned}$$

Hence the particular solution is

$$Y(t) = \int_{t_0}^t (t - s)e^{a(t-s)} g(s) ds.$$

27. Depending on the values of  $a$ ,  $b$  and  $c$ , the operator  $aD^2 + bD + c$  can have *three* types of fundamental solutions.

(i) The characteristic roots  $r_{1,2} = \alpha, \beta$ ;  $\alpha \neq \beta$ .  $y_1(t) = e^{\alpha t}$  and  $y_2(t) = e^{\beta t}$ .

$$K(t) = \frac{1}{\beta - \alpha} [e^{\beta t} - e^{\alpha t}].$$

(ii) The characteristic roots  $r_{1,2} = \alpha, \beta$ ;  $\alpha = \beta$ .  $y_1(t) = e^{\alpha t}$  and  $y_2(t) = te^{\alpha t}$ .

$$K(t) = te^{\alpha t}.$$

(iii) The characteristic roots  $r_{1,2} = \lambda \pm i\mu$ .  $y_1(t) = e^{\lambda t} \cos \mu t$  and  $y_2(t) = e^{\lambda t} \sin \mu t$ .

$$K(t) = \frac{1}{\mu} e^{\lambda t} \sin \mu t.$$

28. Let  $y(t) = v(t)y_1(t)$ , in which  $y_1(t)$  is a solution of the *homogeneous equation*. Substitution into the given ODE results in

$$v''y_1 + 2v'y_1' + vy_1'' + p(t)[v'y_1 + vy_1'] + q(t)vy_1 = g(t).$$

By assumption,  $y_1'' + p(t)y_1' + q(t)y_1 = 0$ , hence  $v(t)$  must be a solution of the ODE

$$v''y_1 + [2y_1' + p(t)y_1]v' = g(t).$$

Setting  $w = v'$ , we also have  $w'y_1 + [2y_1' + p(t)y_1]w = g(t)$ .

30. First write the equation as  $y'' + 7t^{-1}y + 5t^{-2}y = t^{-1}$ . As shown in Prob. 28, the function  $y(t) = t^{-1}v(t)$  is a solution of the given ODE as long as  $v$  is a solution of

$$t^{-1}v'' + [-2t^{-2} + 7t^{-2}]v' = t^{-1},$$

that is,  $v'' + 5t^{-1}v' = 1$ . This ODE is *linear and first order* in  $v'$ . The integrating factor is  $\mu = t^5$ . The solution is  $v' = t/6 + ct^{-5}$ . Direct integration now results in  $v(t) = t^2/12 + c_1t^{-4} + c_2$ . Hence  $y(t) = t/12 + c_1t^{-5} + c_2t^{-1}$ .

31. Write the equation as  $y'' - t^{-1}(1+t)y + t^{-1}y = te^{2t}$ . As shown in Prob. 28, the function  $y(t) = (1+t)v(t)$  is a solution of the given ODE as long as  $v$  is a solution of

$$(1+t)v'' + [2 - t^{-1}(1+t)^2]v' = te^{2t},$$

that is,  $v'' - \frac{1+t^2}{t(t+1)}v' = \frac{t}{t+1}e^{2t}$ . This equation is first order linear in  $v'$ , with integrating factor  $\mu = t^{-1}(1+t)^2e^{-t}$ . The solution is  $v' = (t^2e^{2t} + c_1te^t)/(1+t)^2$ . Integrating, we obtain  $v(t) = e^{2t}/2 - e^{2t}/(t+1) + c_1e^t/(t+1) + c_2$ . Hence the solution of the original ODE is  $y(t) = (t-1)e^{2t}/2 + c_1e^t + c_2(t+1)$ .

32. Write the equation as  $y'' + t(1-t)^{-1}y - (1-t)^{-1}y = 2(1-t)e^{-t}$ . The function  $y(t) = e^tv(t)$  is a solution to the given ODE as long as  $v$  is a solution of

$$e^t v'' + [2e^t + t(1-t)^{-1}e^t]v' = 2(1-t)e^{-t},$$

that is,  $v'' + [(2-t)/(1-t)]v' = 2(1-t)e^{-2t}$ . This equation is first order linear in  $v'$ , with integrating factor  $\mu = e^t/(t-1)$ . The solution is

$$v' = (t-1)(2e^{-2t} + c_1e^{-t}).$$

Integrating, we obtain  $v(t) = (1/2 - t)e^{-2t} - c_1te^{-t} + c_2$ . Hence the solution of the original ODE is  $y(t) = (1/2 - t)e^{-t} - c_1t + c_2e^t$ .

### Section 3.8

1.  $R\cos\delta = 3$  and  $R\sin\delta = 4 \Rightarrow R = \sqrt{25} = 5$  and  $\delta = \arctan(4/3)$ . Hence

$$u = 5 \cos(2t - 0.9273).$$

3.  $R\cos\delta = 4$  and  $R\sin\delta = -2 \Rightarrow R = \sqrt{20} = 2\sqrt{5}$  and  $\delta = -\arctan(1/2)$ . Hence

$$u = 2\sqrt{5} \cos(3t + 0.4636).$$

4.  $R\cos\delta = -2$  and  $R\sin\delta = -3 \Rightarrow R = \sqrt{13}$  and  $\delta = \pi + \arctan(3/2)$ . Hence

$$u = \sqrt{13} \cos(\pi t - 4.1244).$$

5. The spring constant is  $k = 2/(1/2) = 4 \text{ lb/ft}$ . Mass  $m = 2/32 = 1/16 \text{ lb-s}^2/\text{ft}$ . Since there is no damping, the equation of motion is

$$\frac{1}{16}u'' + 4u = 0,$$

that is,  $u'' + 64u = 0$ . The initial conditions are  $u(0) = 1/4 \text{ ft}$ ,  $u'(0) = 0 \text{ fps}$ . The general solution is  $u(t) = A \cos 8t + B \sin 8t$ . Invoking the initial conditions, we have  $u(t) = \frac{1}{4} \cos 8t$ .  $R = 3 \text{ inches}$ ,  $\delta = 0 \text{ rad}$ ,  $\omega_0 = 8 \text{ rad/s}$ , and  $T = \pi/4 \text{ sec}$ .

7. The spring constant is  $k = 3/(1/4) = 12 \text{ lb/ft}$ . Mass  $m = 3/32 \text{ lb-s}^2/\text{ft}$ . Since there is no damping, the equation of motion is

$$\frac{3}{32}u'' + 12u = 0,$$

that is,  $u'' + 128u = 0$ . The initial conditions are  $u(0) = -1/12 \text{ ft}$ ,  $u'(0) = 2 \text{ fps}$ . The general solution is  $u(t) = A \cos 8\sqrt{2}t + B \sin 8\sqrt{2}t$ . Invoking the initial conditions, we have



$$u(t) = -\frac{1}{12} \cos 8\sqrt{2}t + \frac{1}{4\sqrt{2}} \sin 8\sqrt{2}t.$$

$R = \sqrt{11}/12 \text{ ft}$ ,  $\delta = \pi - \text{atan}(3/\sqrt{2}) \text{ rad}$ ,  $\omega_0 = 8\sqrt{2} \text{ rad/s}$ , and  $T = \pi/(4\sqrt{2}) \text{ sec}$ .

10. The spring constant is  $k = 16/(1/4) = 64 \text{ lb/ft}$ . Mass  $m = 1/2 \text{ lb-s}^2/\text{ft}$ . The damping coefficient is  $\gamma = 2 \text{ lb-sec/ft}$ . Hence the equation of motion is

$$\frac{1}{2}u'' + 2u' + 64u = 0,$$

that is,  $u'' + 4u' + 128u = 0$ . The initial conditions are  $u(0) = 0 \text{ ft}$ ,  $u'(0) = 1/4 \text{ fps}$ . The general solution is  $u(t) = A \cos 2\sqrt{31}t + B \sin 2\sqrt{31}t$ . Invoking the initial conditions, we have

$$u(t) = \frac{1}{8\sqrt{31}} e^{-2t} \sin 2\sqrt{31}t.$$

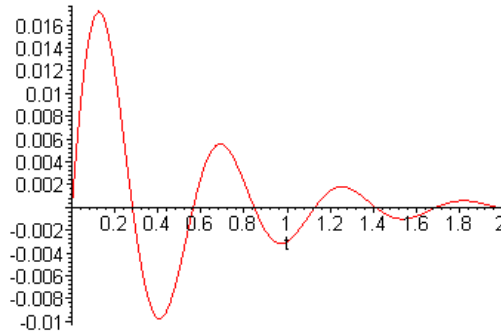

Solving  $u(t) = 0$ , on the interval  $[0.2, 0.4]$ , we obtain  $t = \pi/2\sqrt{31} = 0.2821 \text{ sec}$ . Based on the graph, and the solution of  $u(t) = 0.01$ , we have  $|u(t)| \leq 0.01$  for  $t \geq \tau = 0.2145$ .

11. The spring constant is  $k = 3/(.1) = 30 \text{ N/m}$ . The damping coefficient is given as  $\gamma = 3/5 \text{ N-sec/m}$ . Hence the equation of motion is

$$2u'' + \frac{3}{5}u' + 30u = 0,$$

that is,  $u'' + 0.3u' + 15u = 0$ . The initial conditions are  $u(0) = 0.05 \text{ m}$  and  $u'(0) = 0.01 \text{ m/s}$ . The general solution is  $u(t) = A \cos \mu t + B \sin \mu t$ , in which  $\mu = 3.87008 \text{ rad/s}$ . Invoking the initial conditions, we have

$$u(t) = e^{-0.15t}(0.05 \cos \mu t + 0.00452 \sin \mu t).$$

Also,  $\mu/\omega_0 = 3.87008/\sqrt{15} \approx 0.99925$ .

13. The frequency of the *undamped* motion is  $\omega_0 = 1$ . The quasi frequency of the damped motion is  $\mu = \frac{1}{2}\sqrt{4 - \gamma^2}$ . Setting  $\mu = \frac{2}{3}\omega_0$ , we obtain  $\gamma = \frac{2}{3}\sqrt{5}$ .

14. The spring constant is  $k = mg/L$ . The equation of motion for an undamped system is

$$mu'' + \frac{mg}{L}u = 0.$$

Hence the natural frequency of the system is  $\omega_0 = \sqrt{\frac{g}{L}}$ . The period is  $T = 2\pi/\omega_0$ .

15. The general solution of the system is  $u(t) = A \cos \gamma(t - t_0) + B \sin \gamma(t - t_0)$ . Invoking the initial conditions, we have  $u(t) = u_0 \cos \gamma(t - t_0) + (u'_0/\gamma) \sin \gamma(t - t_0)$ . Clearly, the functions  $v = u_0 \cos \gamma(t - t_0)$  and  $w = (u'_0/\gamma) \sin \gamma(t - t_0)$  satisfy the given criteria.

16. Note that  $r \sin(\omega_0 t - \theta) = r \sin \omega_0 t \cos \theta - r \cos \omega_0 t \sin \theta$ . Comparing the given expressions, we have  $A = -r \sin \theta$  and  $B = r \cos \theta$ . That is,  $r = R = \sqrt{A^2 + B^2}$ , and  $\tan \theta = -A/B = -1/\tan \delta$ . The latter relation is also  $\tan \theta + \cot \delta = 1$ .

18. The system is *critically damped*, when  $R = 2\sqrt{L/C}$ . Here  $R = 1000$  ohms.

21(a). Let  $u = Re^{-\gamma t/2m} \cos(\mu t - \delta)$ . Then attains a *maximum* when  $\mu t_k - \delta = 2k\pi$ . Hence  $T_d = t_{k+1} - t_k = 2\pi/\mu$ .

(b).  $u(t_k)/u(t_{k+1}) = \exp(-\gamma t_k/2m)/\exp(-\gamma t_{k+1}/2m) = \exp[(\gamma t_{k+1} - \gamma t_k)/2m]$ . Hence  $u(t_k)/u(t_{k+1}) = \exp[\gamma(2\pi/\mu)/2m] = \exp(\gamma T_d/2m)$ .

(c).  $\Delta = \ln[u(t_k)/u(t_{k+1})] = \gamma(2\pi/\mu)/2m = \pi\gamma/\mu m$ .

22. The spring constant is  $k = 16/(1/4) = 64$  lb/ft. Mass  $m = 1/2$  lb-s<sup>2</sup>/ft. The damping coefficient is  $\gamma = 2$  lb-sec/ft. The quasi frequency is  $\mu = 2\sqrt{31}$  rad/s. Hence  $\Delta = \frac{2\pi}{\sqrt{31}} \approx 1.1285$ .

25(a). The solution of the IVP is  $u(t) = e^{-t/8} \left( 2 \cos \frac{3}{8} \sqrt{7} t + 0.252 \sin \frac{3}{8} \sqrt{7} t \right)$ .

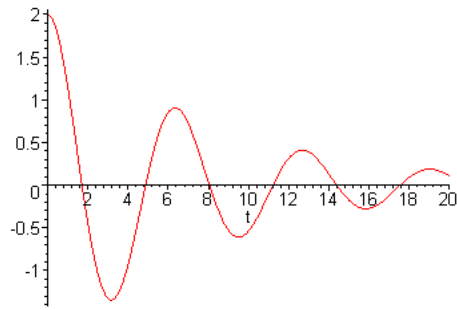

Using the plot, and numerical analysis,  $\tau \approx 41.715$ .

(b). For  $\gamma = 0.5$ ,  $\tau \approx 20.402$ ; for  $\gamma = 1.0$ ,  $\tau \approx 9.168$ ; for  $\gamma = 1.5$ ,  $\tau \approx 7.184$ .

(c).

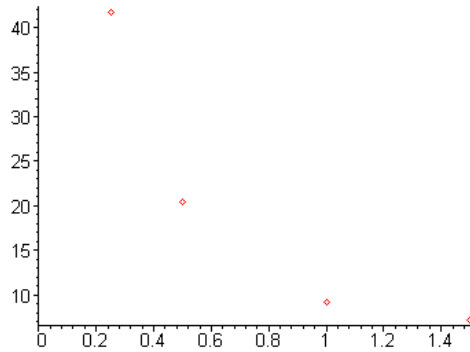

(d). For  $\gamma = 1.6$ ,  $\tau \approx 7.218$ ; for  $\gamma = 1.7$ ,  $\tau \approx 6.767$ ; for  $\gamma = 1.8$ ,  $\tau \approx 5.473$ ; for  $\gamma = 1.9$ ,  $\tau \approx 6.460$ .  $\tau$  steadily decreases to about  $\tau_{min} \approx 4.873$ , corresponding to the critical value  $\gamma_0 \approx 1.73$ .

(e). We have  $u(t) = \frac{4e^{-\gamma t/2}}{\sqrt{4-\gamma^2}} \cos(\mu t - \delta)$ , in which  $\mu = \frac{1}{2}\sqrt{4-\gamma^2}$ , and  $\delta = \tan^{-1} \frac{\gamma}{\sqrt{4-\gamma^2}}$ . Hence  $|u(t)| \leq \frac{4e^{-\gamma t/2}}{\sqrt{4-\gamma^2}}$ .

26(a). The characteristic equation is  $mr^2 + \gamma r + k = 0$ . Since  $\gamma^2 < 4km$ , the roots are  $r_{1,2} = -\frac{\gamma}{2m} \pm i \frac{\sqrt{4mk-\gamma^2}}{2m}$ . The general solution is

$$u(t) = e^{-\gamma t/2m} \left[ A \cos \frac{\sqrt{4mk-\gamma^2}}{2m} t + B \sin \frac{\sqrt{4mk-\gamma^2}}{2m} t \right].$$

Invoking the initial conditions,  $A = u_0$  and

$$B = \frac{(2mv_0 - \gamma u_0)}{\sqrt{4mk - \gamma^2}}.$$

(b). We can write  $u(t) = R e^{-\gamma t/2m} \cos(\mu t - \delta)$ , in which

$$R = \sqrt{u_0^2 + \frac{(2mv_0 - \gamma u_0)^2}{4mk - \gamma^2}},$$

and

$$\delta = \arctan \left[ \frac{(2mv_0 - \gamma u_0)}{u_0 \sqrt{4mk - \gamma^2}} \right].$$

(c).  $R = \sqrt{u_0^2 + \frac{(2mv_0 - \gamma u_0)^2}{4mk - \gamma^2}} = 2\sqrt{\frac{m(ku_0^2 + \gamma u_0 v_0 + mv_0^2)}{4mk - \gamma^2}} = \sqrt{\frac{a+b\gamma}{4mk - \gamma^2}}.$

It is evident that  $R$  increases (*monotonically*) without bound as  $\gamma \rightarrow (2\sqrt{mk})^-$ .

28(a). The general solution is  $u(t) = A \cos \sqrt{2}t + B \sin \sqrt{2}t$ . Invoking the initial conditions, we have  $u(t) = \sqrt{2} \sin \sqrt{2}t$ .

(b).

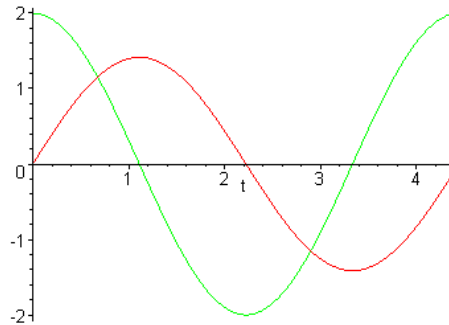

(c).

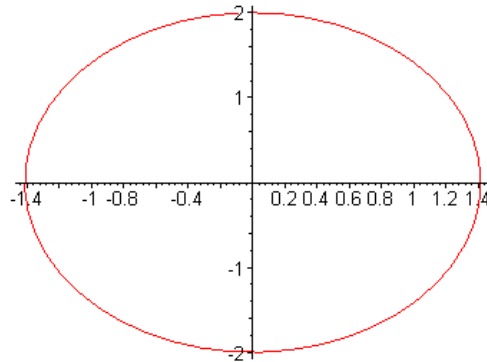

The condition  $u'(0) = 2$  implies that  $u(t)$  *initially* increases. Hence the phase point travels *clockwise*.

29.  $u(t) = \frac{16}{\sqrt{127}} e^{-t/8} \sin \frac{\sqrt{127}}{8} t.$

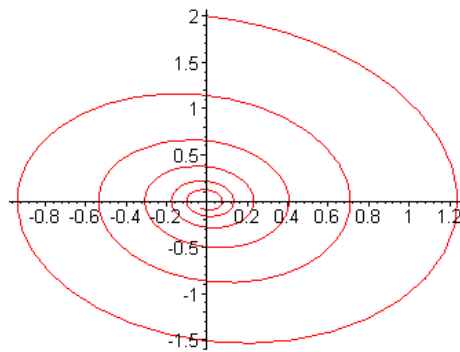

31. Based on *Newton's second law*, with the positive direction to the right,

$$\sum F = mu''$$

where

$$\sum F = -ku - \gamma u'.$$

Hence the equation of motion is  $mu'' + \gamma u' + ku = 0$ . The only difference in this problem is that the equilibrium position is located at the *unstretched* configuration of the spring.

32(a). The *restoring* force exerted by the spring is  $F_s = -(ku + \varepsilon u^3)$ . The *opposing* viscous force is  $F_d = -\gamma u'$ . Based on *Newton's second law*, with the positive direction to the right,

$$F_s + F_d = mu''.$$

Hence the equation of motion is  $mu'' + \gamma u' + ku + \varepsilon u^3 = 0$ .

(b). With the specified parameter values, the equation of motion is  $u'' + u = 0$ . The general solution of this ODE is  $u(t) = A \cos t + B \sin t$ . Invoking the initial conditions, the specific solution is  $u(t) = \sin t$ . Clearly, the amplitude is  $R = 1$ , and the period of the motion is  $T = 2\pi$ .

(c). Given  $\varepsilon = 0.1$ , the equation of motion is  $u'' + u + 0.1 u^3 = 0$ . A solution of the

IVP can be generated numerically:

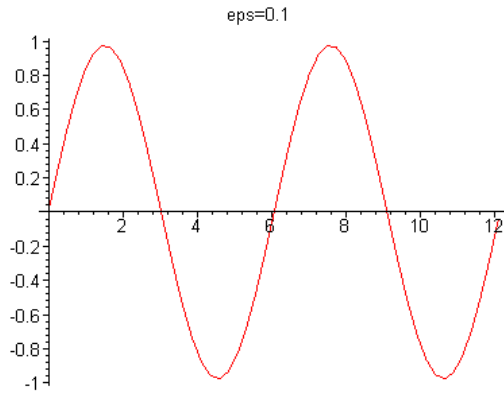

(d).

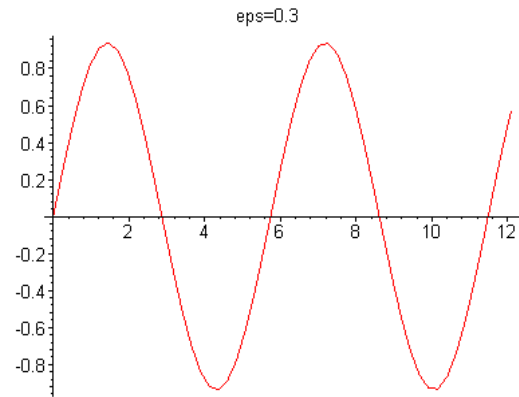
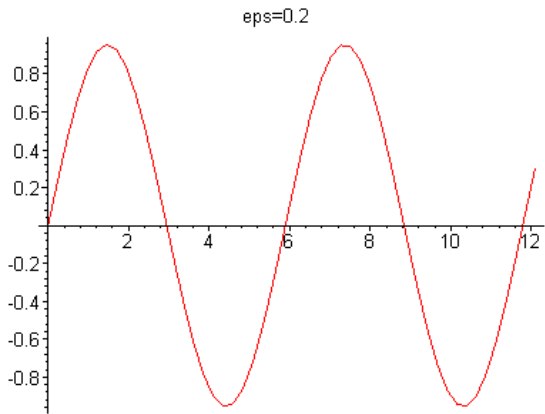

(e). The amplitude and period both seem to *decrease*.

(f).

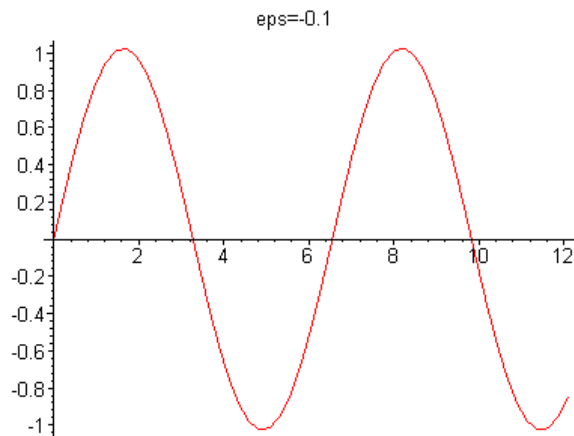

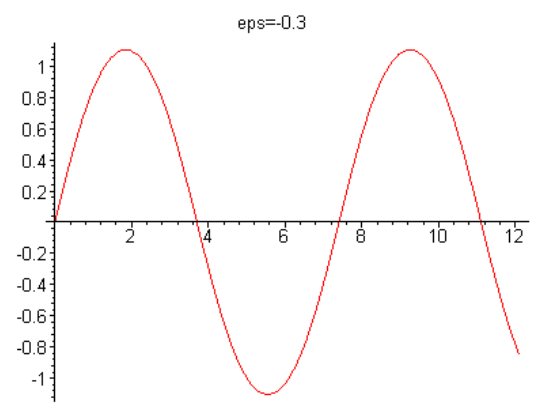
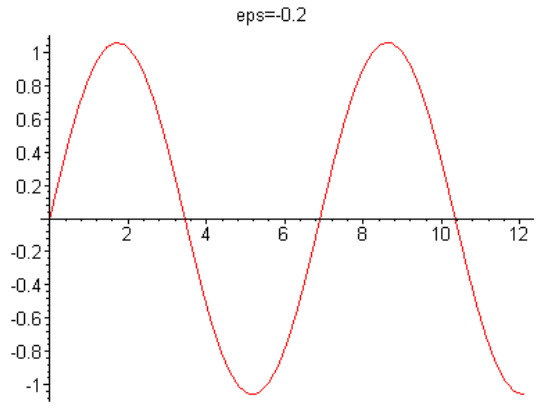

### Section 3.9

2. We have  $\sin(\alpha \pm \beta) = \sin \alpha \cos \beta \pm \cos \alpha \sin \beta$ . Subtracting the two identities, we obtain  $\sin(\alpha + \beta) - \sin(\alpha - \beta) = 2 \cos \alpha \sin \beta$ . Setting  $\alpha + \beta = 7t$  and  $\alpha - \beta = 6t$ ,  $\alpha = 6.5t$  and  $\beta = 0.5t$ . Hence  $\sin 7t - \sin 6t = 2 \sin \frac{t}{2} \cos \frac{13t}{2}$ .

3. Consider the trigonometric identity  $\cos(\alpha \pm \beta) = \cos \alpha \cos \beta \mp \sin \alpha \sin \beta$ . Adding the two identities, we obtain  $\cos(\alpha - \beta) + \cos(\alpha + \beta) = 2 \cos \alpha \cos \beta$ . Comparing the expressions, set  $\alpha + \beta = 2\pi t$  and  $\alpha - \beta = \pi t$ . Hence  $\alpha = 3\pi t/2$  and  $\beta = \pi t/2$ . Upon substitution, we have  $\cos(\pi t) + \cos(2\pi t) = 2 \cos(3\pi t/2) \cos(\pi t/2)$ .

4. Adding the two identities  $\sin(\alpha \pm \beta) = \sin \alpha \cos \beta \pm \cos \alpha \sin \beta$ , it follows that  $\sin(\alpha - \beta) + \sin(\alpha + \beta) = 2 \sin \alpha \cos \beta$ . Setting  $\alpha + \beta = 4t$  and  $\alpha - \beta = 3t$ , we have  $\alpha = 7t/2$  and  $\beta = t/2$ . Hence  $\sin 3t + \sin 4t = 2 \sin(7t/2) \cos(t/2)$ .

6. Using *mks* units, the spring constant is  $k = 5(9.8)/0.1 = 490 \text{ N/m}$ , and the damping coefficient is  $\gamma = 2/0.04 = 50 \text{ N-sec/m}$ . The equation of motion is

$$5u'' + 50u' + 490u = 10 \sin(t/2).$$

The initial conditions are  $u(0) = 0 \text{ m}$  and  $u'(0) = 0.03 \text{ m/s}$ .

8(a). The homogeneous solution is  $u_c(t) = Ae^{-5t} \cos \sqrt{73}t + Be^{-5t} \sin \sqrt{73}t$ . Based on the method of *undetermined coefficients*, the particular solution is

$$U(t) = \frac{1}{153281} [-160 \cos(t/2) + 3128 \sin(t/2)].$$

Hence the general solution of the ODE is  $u(t) = u_c(t) + U(t)$ . Invoking the initial conditions, we find that  $A = 160/153281$  and  $B = 383443\sqrt{73}/1118951300$ . Hence the response is

$$u(t) = \frac{1}{153281} \left[ 160 e^{-5t} \cos \sqrt{73}t + \frac{383443\sqrt{73}}{7300} e^{-5t} \sin \sqrt{73}t \right] + U(t).$$

(b).  $u_c(t)$  is the transient part and  $U(t)$  is the steady state part of the response.



(c).

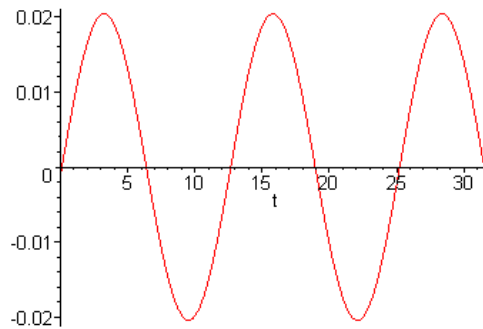

(d). Based on Eqs. (9) and (10), the amplitude of the forced response is given by  $R = 2/\Delta$ , in which

$$\Delta = \sqrt{25(98 - \omega^2)^2 + 2500\omega^2}.$$

The maximum amplitude is attained when  $\Delta$  is a *minimum*. Hence the amplitude is maximum at  $\omega = 4\sqrt{3}$  rad/s.

9. The spring constant is  $k = 12$  lb/ft and hence the equation of motion is

$$\frac{6}{32}u'' + 12u = 4 \cos 7t,$$

that is,  $u'' + 64u = \frac{64}{3} \cos 7t$ . The initial conditions are  $u(0) = 0$  ft,  $u'(0) = 0$  fps. The general solution is  $u(t) = A \cos 8t + B \sin 8t + \frac{64}{45} \cos 7t$ . Invoking the initial conditions, we have  $u(t) = -\frac{64}{45} \cos 8t + \frac{64}{45} \cos 7t = \frac{128}{45} \sin(t/2) \sin(15t/2)$ .

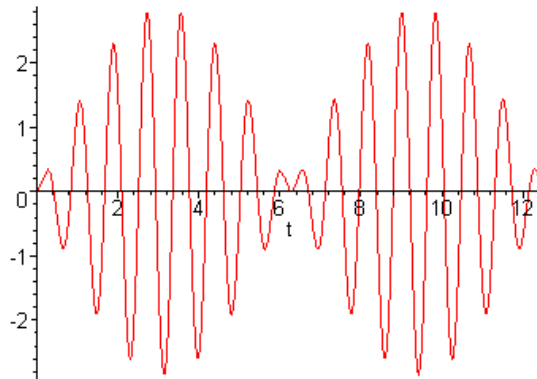

12. The equation of motion is

$$2u'' + u' + 3u = 3 \cos 3t - 2 \sin 3t.$$

Since the system is *damped*, the steady state response is equal to the particular solution. Using the method of *undetermined coefficients*, we obtain

$$u_{ss}(t) = \frac{1}{6}(\sin 3t - \cos 3t).$$

Further, we find that  $R = \sqrt{2}/6$  and  $\delta = \arctan(-1) = 3\pi/4$ . Hence we can write  $u_{ss}(t) = \frac{\sqrt{2}}{6}\cos(3t - 3\pi/4)$ .

13. The amplitude of the steady-state response is given by

$$R = \frac{F_0}{\sqrt{m^2(\omega_0^2 - \omega^2)^2 + \gamma^2 \omega^2}}.$$

Since  $F_0$  is constant, the amplitude is *maximum* when the denominator of  $R$  is *minimum*. Let  $z = \omega^2$ , and consider the function  $f(z) = m^2(\omega_0^2 - z)^2 + \gamma^2 z$ . Note that  $f(z)$  is a quadratic, with *minimum* at  $z = \omega_0^2 - \gamma^2/2m^2$ . Hence the amplitude  $R$  attains a maximum at  $\omega_{max}^2 = \omega_0^2 - \gamma^2/2m^2$ . Furthermore, since  $\omega_0^2 = k/m$ , and therefore

$$\omega_{max}^2 = \omega_0^2 \left[ 1 - \frac{\gamma^2}{2km} \right].$$

Substituting  $\omega^2 = \omega_{max}^2$  into the expression for the amplitude,

$$\begin{aligned} R &= \frac{F_0}{\sqrt{\gamma^4/4m^2 + \gamma^2(\omega_0^2 - \gamma^2/2m^2)}} \\ &= \frac{F_0}{\sqrt{\omega_0^2 \gamma^2 - \gamma^4/4m^2}} \\ &= \frac{F_0}{\gamma \omega_0 \sqrt{1 - \gamma^2/4mk}}. \end{aligned}$$

14(a). The forced response is  $u_{ss}(t) = A\cos \omega t + B\sin \omega t$ . The constants are obtain by the method of *undetermined coefficients*. That is, comparing the coefficients of  $\cos \omega t$  and  $\sin \omega t$ , we find that

$$-m\omega^2 A + \gamma\omega B + kA = F_0, \text{ and } -m\omega^2 B - \gamma\omega A + kB = 0.$$

Solving this system results in

$$A = m(\omega_0^2 - \omega^2)/\Delta \text{ and } B = \gamma\omega/\Delta,$$

in which  $\Delta = \sqrt{m^2(\omega_0^2 - \omega^2)^2 + \gamma^2 \omega^2}$ . It follows that

$$\tan \delta = B/A = \frac{\gamma\omega}{m(\omega_0^2 - \omega^2)}.$$

(b). Here  $m = 1$ ,  $\gamma = 0.125$ ,  $\omega_0 = 1$ . Hence  $\tan \delta = 0.125\omega/(1 - \omega^2)$ .

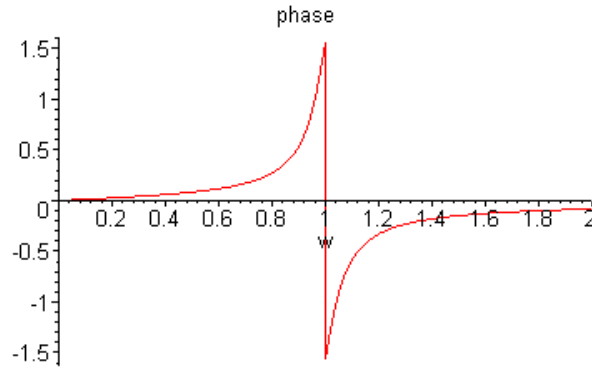

17(a). Here  $m = 1$ ,  $\gamma = 0.25$ ,  $\omega_0^2 = 2$ ,  $F_0 = 2$ . Hence  $u_{ss}(t) = \frac{2}{\Delta} \cos(\omega t - \delta)$ , where  $\Delta = \sqrt{(2 - \omega^2)^2 + \omega^2/16} = \frac{1}{4} \sqrt{64 - 63\omega^2 + 16\omega^4}$ , and  $\tan \delta = \frac{\omega}{4(2 - \omega^2)}$ .

(b). The amplitude is

$$R = \frac{8}{\sqrt{64 - 63\omega^2 + 16\omega^4}}.$$

(c).

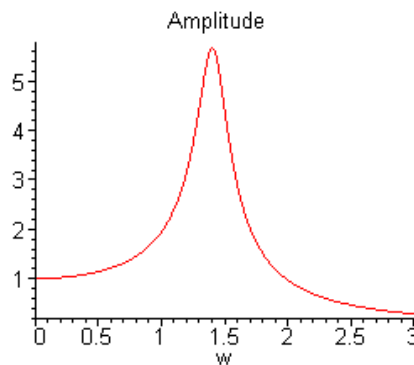

(d). See Prob. 13. The amplitude is maximum when the denominator of  $R$  is minimum. That is, when  $\omega = \omega_{max} = 3\sqrt{14}/8 \approx 1.4031$ . Hence  $R(\omega = \omega_{max}) = 64/\sqrt{127}$ .

18(a). The homogeneous solution is  $u_c(t) = A \cos t + B \sin t$ . Based on the method of *undetermined coefficients*, the particular solution is

$$U(t) = \frac{3}{1 - \omega^2} \cos \omega t.$$

Hence the general solution of the ODE is  $u(t) = u_c(t) + U(t)$ . Invoking the initial conditions, we find that  $A = 3/(\omega^2 - 1)$  and  $B = 0$ . Hence the response is

$$u(t) = \frac{3}{1 - \omega^2} [\cos \omega t - \cos t].$$

(b).

$\omega = 0.7$

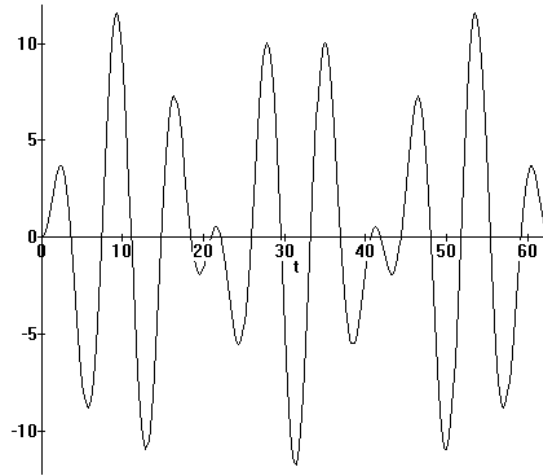

$\omega = 0.8$

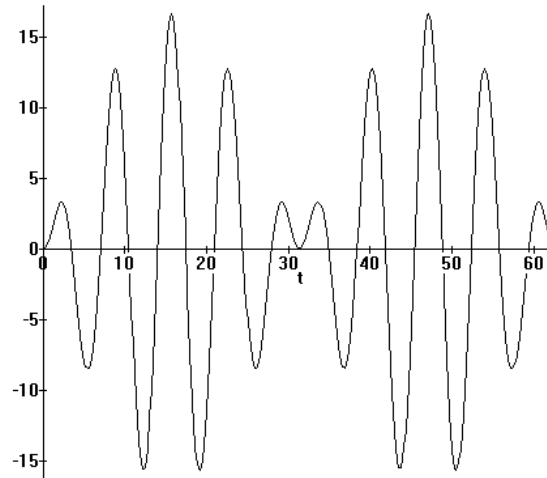

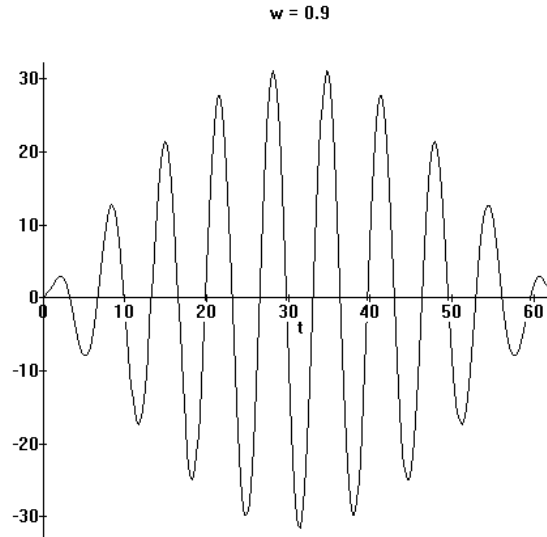

Note that

$$u(t) = \frac{6}{1 - \omega^2} \sin \left[ \frac{(1 - \omega)t}{2} \right] \sin \left[ \frac{(\omega + 1)t}{2} \right].$$

19(a). The homogeneous solution is  $u_c(t) = A \cos t + B \sin t$ . Based on the method of *undetermined coefficients*, the particular solution is

$$U(t) = \frac{3}{1 - \omega^2} \cos \omega t.$$

Hence the general solution is  $u(t) = u_c(t) + U(t)$ . Invoking the initial conditions, we find that  $A = (\omega^2 + 2)/(\omega^2 - 1)$  and  $B = 1$ . Hence the response is

$$u(t) = \frac{1}{1 - \omega^2} [3 \cos \omega t - (\omega^2 + 2) \cos t] + \sin t.$$

(b.)

$w = 0.7$

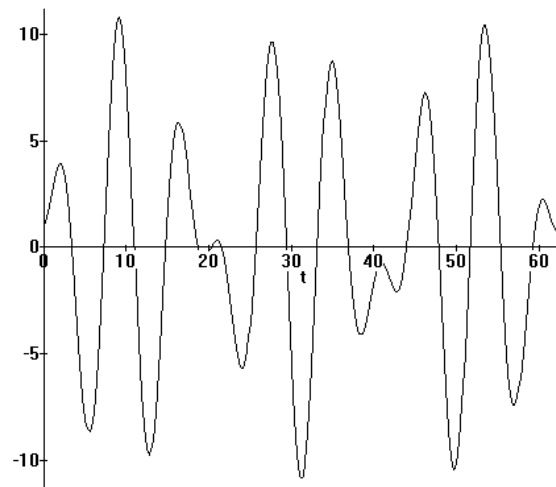

$w = 0.8$

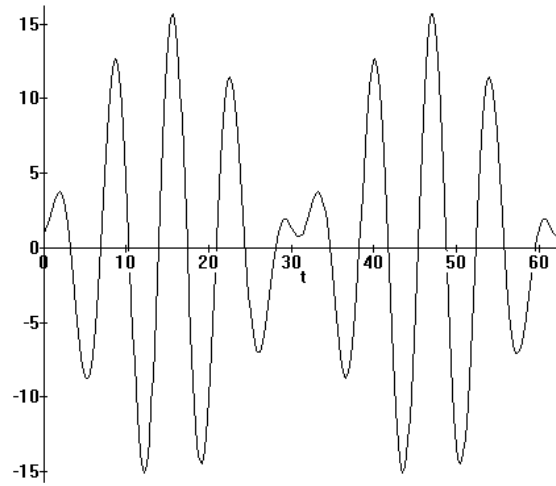

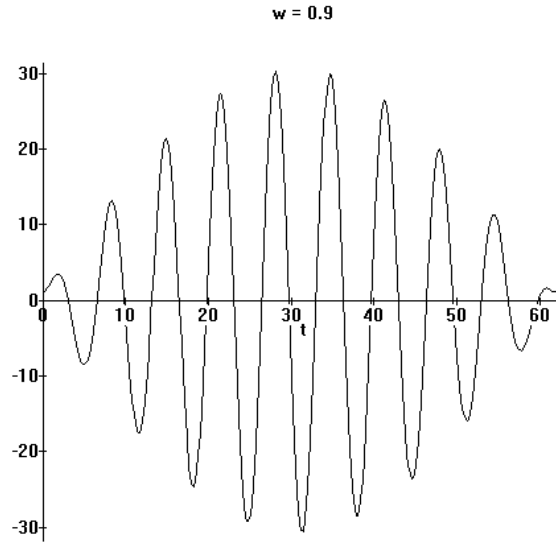

Note that

$$u(t) = \frac{6}{1 - \omega^2} \sin\left[\frac{(1 - \omega)t}{2}\right] \sin\left[\frac{(\omega + 1)t}{2}\right] + \cos t + \sin t.$$

20.

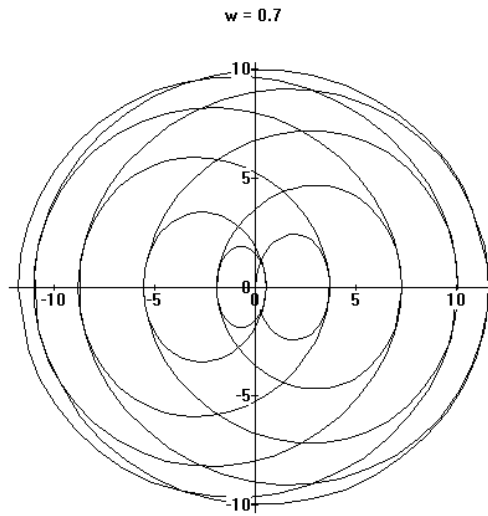

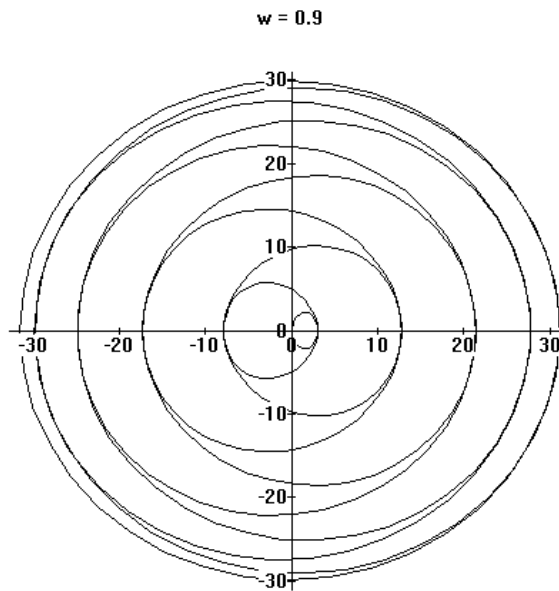
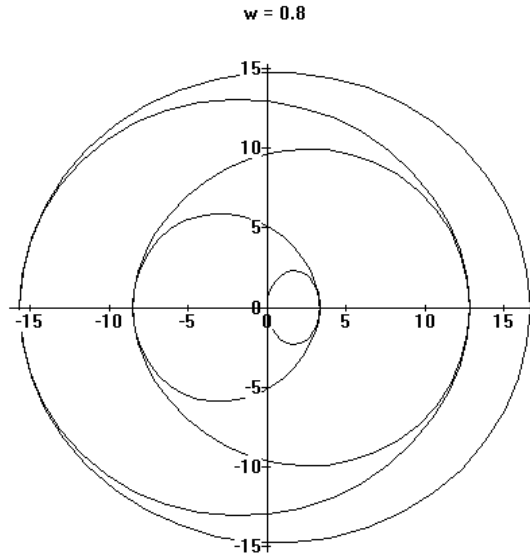

21. The general solution is  $u(t) = u_c(t) + U(t)$ , in which

$$u_c(t) = e^{-t/16} \left[ -\frac{171358}{132721} \cos \frac{\sqrt{255}}{16} t - \frac{257758}{132721\sqrt{255}} \sin \frac{\sqrt{255}}{16} t \right]$$

and

$$U(t) = \frac{1}{132721} [436800 \cos(.3t) + 18000 \sin(.3t)].$$



(a).

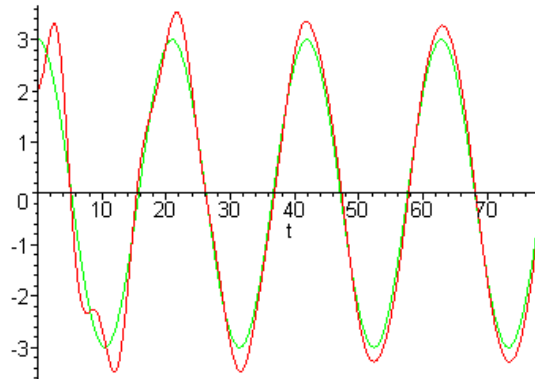

(b).

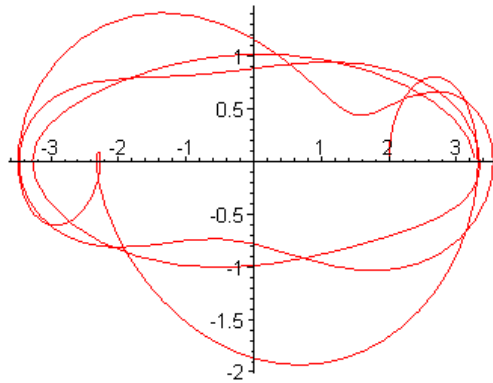

23. The general solution is  $u(t) = u_c(t) + U(t)$ , in which

$$u_c(t) = e^{-t/16} \left[ \frac{9746}{4105} \cos \frac{\sqrt{255}}{16} t + \frac{1258}{821\sqrt{255}} \sin \frac{\sqrt{255}}{16} t \right]$$

and

$$U(t) = \frac{1}{4105} [-1536 \cos(3t) + 72 \sin(3t)].$$

(a).

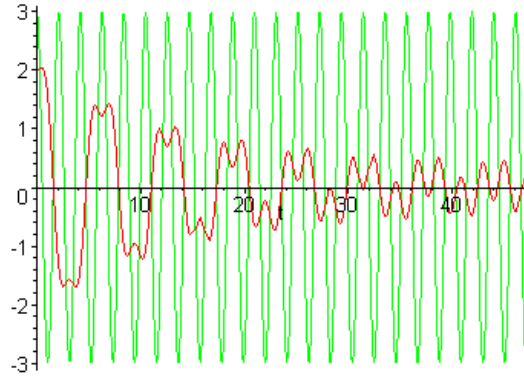

(b).

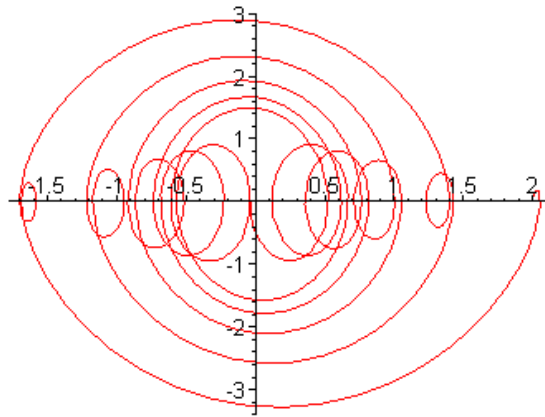

24.

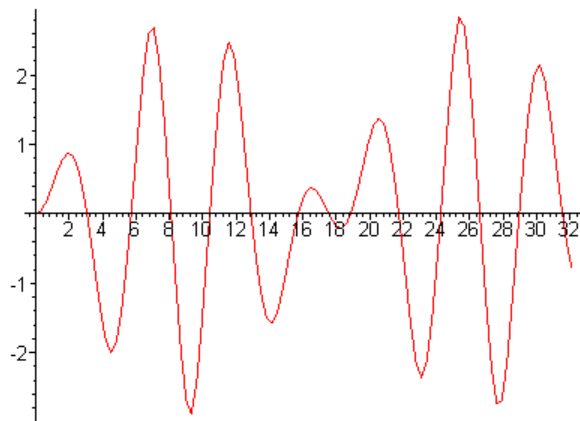

25(a).

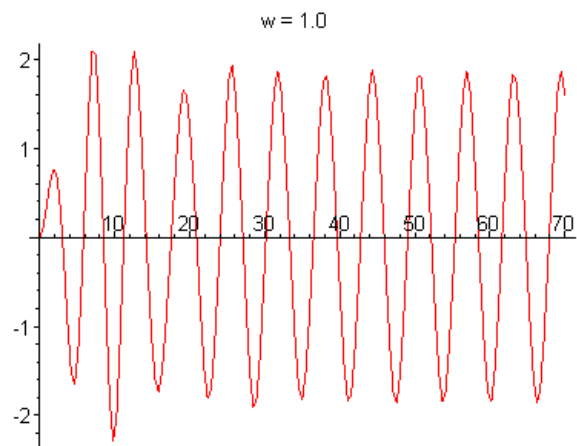
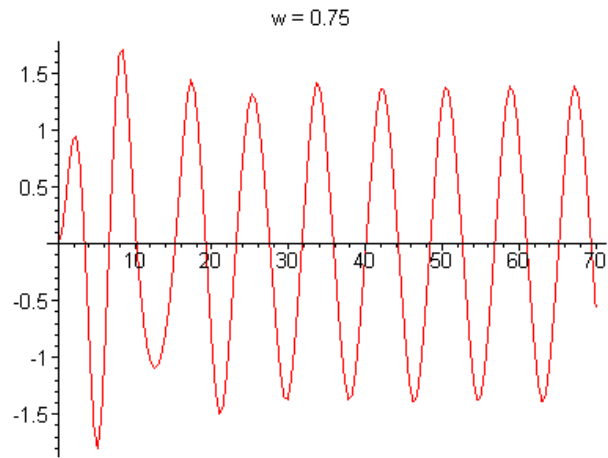
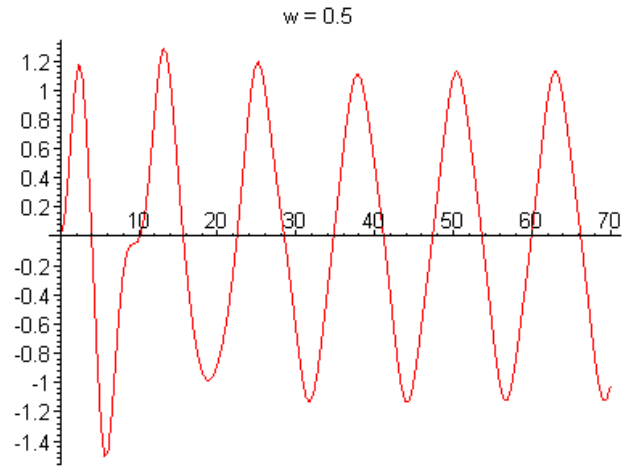

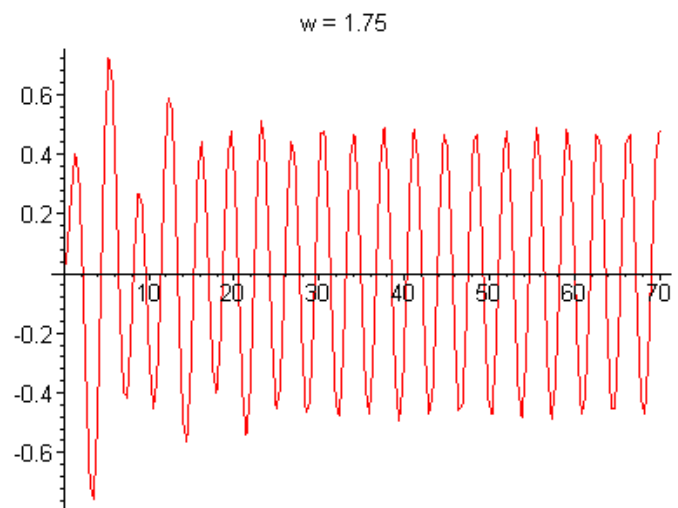
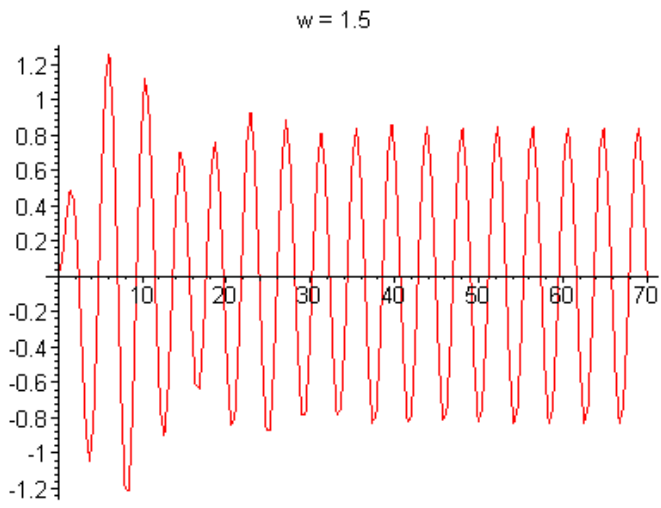
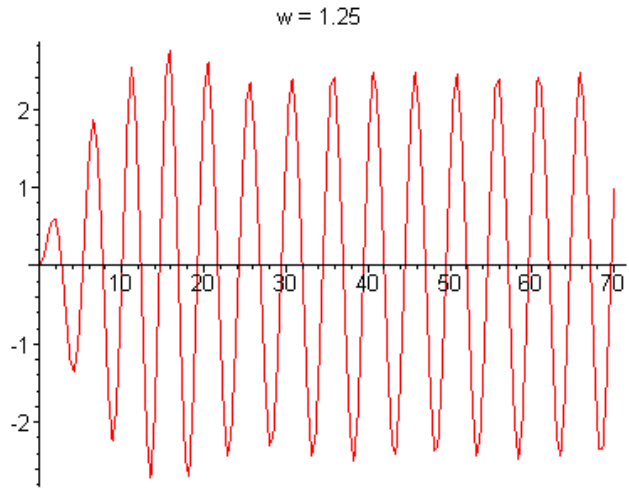

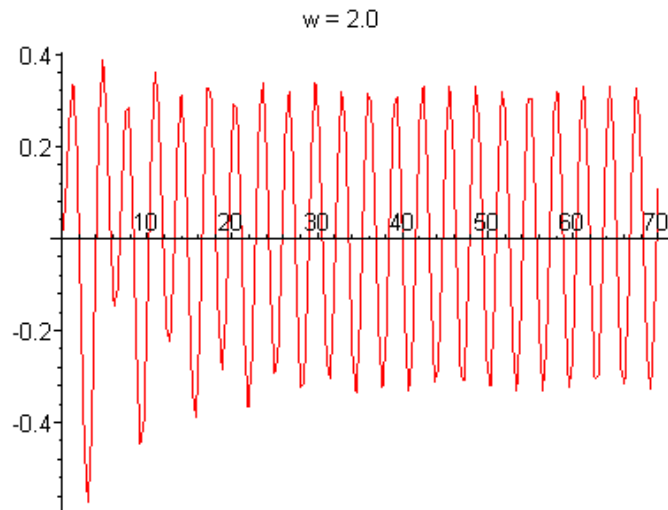

(b).

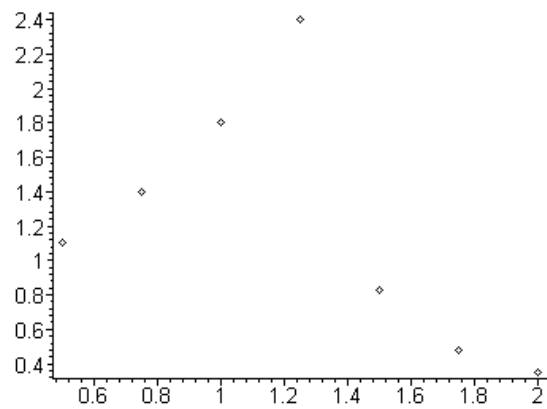

(c). The amplitude for a similar system with a *linear* spring is given by

$$R = \frac{5}{\sqrt{25 - 49\omega^2 + 25\omega^4}}.$$

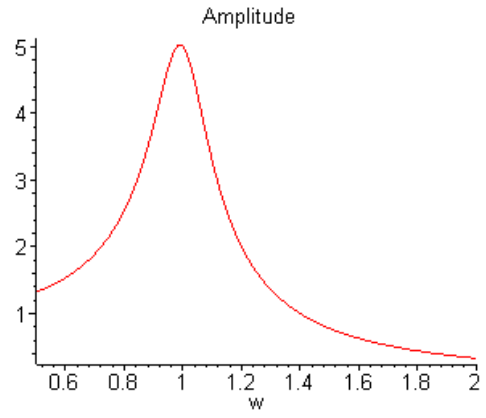

## Chapter Four

### Section 4.1

1. The differential equation is in standard form. Its coefficients, as well as the function  $g(t) = t$ , are continuous *everywhere*. Hence solutions are valid on the entire real line.
3. Writing the equation in standard form, the coefficients are *rational* functions with singularities at  $t = 0$  and  $t = 1$ . Hence the solutions are valid on the intervals  $(-\infty, 0)$ ,  $(0, 1)$ , and  $(1, \infty)$ .
4. The coefficients are continuous everywhere, but the function  $g(t) = \ln t$  is defined and continuous only on the interval  $(0, \infty)$ . Hence solutions are defined for positive reals.
5. Writing the equation in standard form, the coefficients are *rational* functions with a singularity at  $x_0 = 1$ . Furthermore,  $p_4(x) = \tan x / (x - 1)$  is *undefined*, and hence not continuous, at  $x_k = \pm(2k + 1)\pi/2$ ,  $k = 0, 1, 2, \dots$ . Hence solutions are defined on any *interval* that *does not* contain  $x_0$  or  $x_k$ .
6. Writing the equation in standard form, the coefficients are *rational* functions with singularities at  $x = \pm 2$ . Hence the solutions are valid on the intervals  $(-\infty, -2)$ ,  $(-2, 2)$ , and  $(2, \infty)$ .
7. Evaluating the Wronskian of the three functions,  $W(f_1, f_2, f_3) = -14$ . Hence the functions are linearly *independent*.
9. Evaluating the Wronskian of the four functions,  $W(f_1, f_2, f_3, f_4) = 0$ . Hence the functions are linearly *dependent*. To find a linear relation among the functions, we need to find constants  $c_1, c_2, c_3, c_4$ , not all zero, such that

$$c_1 f_1(t) + c_2 f_2(t) + c_3 f_3(t) + c_4 f_4(t) = 0.$$

Collecting the common terms, we obtain

$$(c_2 + 2c_3 + c_4)t^2 + (2c_1 - c_3 + c_4)t + (-3c_1 + c_2 + c_4) = 0,$$

which results in *three* equations in *four* unknowns. Arbitrarily setting  $c_4 = -1$ , we can solve the equations  $c_2 + 2c_3 = 1$ ,  $2c_1 - c_3 = 1$ ,  $-3c_1 + c_2 = 1$ , to find that  $c_1 = 2/7$ ,  $c_2 = 13/7$ ,  $c_3 = -3/7$ . Hence

$$2f_1(t) + 13f_2(t) - 3f_3(t) - 7f_4(t) = 0.$$

10. Evaluating the Wronskian of the three functions,  $W(f_1, f_2, f_3) = 156$ . Hence the functions are linearly *independent*.

11. Substitution verifies that the functions are solutions of the ODE. Furthermore, we have

$$W(1, \cos t, \sin t) = 1.$$

12. Substitution verifies that the functions are solutions of the ODE. Furthermore, we have  $W(1, t, \cos t, \sin t) = 1$ .

14. Substitution verifies that the functions are solutions of the ODE. Furthermore, we have  $W(1, t, e^{-t}, t e^{-t}) = e^{-2t}$ .

15. Substitution verifies that the functions are solutions of the ODE. Furthermore, we have  $W(1, x, x^3) = 6x$ .

16. Substitution verifies that the functions are solutions of the ODE. Furthermore, we have  $W(x, x^2, 1/x) = 6/x$ .

18. The operation of taking a derivative is linear, and hence

$$(c_1 y_1 + c_2 y_2)^{(k)} = c_1 y_1^{(k)} + c_2 y_2^{(k)}.$$

It follows that

$$L[c_1 y_1 + c_2 y_2] = c_1 y_1^{(n)} + c_2 y_2^{(n)} + p_1 [c_1 y_1^{(n-1)} + c_2 y_2^{(n-1)}] + \cdots + p_n [c_1 y_1 + c_2 y_2].$$

Rearranging the terms, we obtain  $L[c_1 y_1 + c_2 y_2] = c_1 L[y_1] + c_2 L[y_2]$ . Since  $y_1$  and  $y_2$  are solutions,  $L[c_1 y_1 + c_2 y_2] = 0$ . The rest follows by induction.

19(a). Note that  $d^k(t^n)/dt^k = n(n-1)\cdots(n-k+1)t^{n-k}$ , for  $k = 1, 2, \dots, n$ . Hence

$$L[t^n] = a_0 n! + a_1 [n(n-1)\cdots 2]t + \cdots a_{n-1} n t^{n-1} + a_n t^n.$$

(b). We have  $d^k(e^{rt})/dt^k = r^k e^{rt}$ , for  $k = 0, 1, 2, \dots$ . Hence

$$\begin{aligned} L[e^{rt}] &= a_0 r^n e^{rt} + a_1 r^{n-1} e^{rt} + \cdots a_{n-1} r e^{rt} + a_n e^{rt} \\ &= [a_0 r^n + a_1 r^{n-1} + \cdots a_{n-1} r + a_n] e^{rt}. \end{aligned}$$

(c). Set  $y = e^{rt}$ , and substitute into the ODE. It follows that  $r^4 - 5r^2 + 4 = 0$ , with  $r = \pm 1, \pm 2$ . Furthermore,  $W(e^t, e^{-t}, e^{2t}, e^{-2t}) = 72$ .

20(a). Let  $f(t)$  and  $g(t)$  be arbitrary functions. Then  $W(f, g) = fg' - f'g$ . Hence  $W'(f, g) = f'g' + fg'' - f''g - f'g' = fg'' - f''g$ . That is,

$$W'(f, g) = \begin{vmatrix} f & g \\ f'' & g'' \end{vmatrix}.$$

Now expand the 3-by-3 determinant as



$$W(y_1, y_2, y_3) = y_1 \begin{vmatrix} y_2' & y_3' \\ y_2'' & y_3'' \end{vmatrix} - y_2 \begin{vmatrix} y_1' & y_3' \\ y_1'' & y_3'' \end{vmatrix} + y_3 \begin{vmatrix} y_1' & y_2' \\ y_1'' & y_2'' \end{vmatrix}.$$

Differentiating, we obtain

$$W'(y_1, y_2, y_3) = y_1' \begin{vmatrix} y_2' & y_3' \\ y_2'' & y_3'' \end{vmatrix} - y_2' \begin{vmatrix} y_1' & y_3' \\ y_1'' & y_3'' \end{vmatrix} + y_3' \begin{vmatrix} y_1' & y_2' \\ y_1'' & y_2'' \end{vmatrix} + y_1 \begin{vmatrix} y_2' & y_3' \\ y_2''' & y_3''' \end{vmatrix} - y_2 \begin{vmatrix} y_1' & y_3' \\ y_1''' & y_3''' \end{vmatrix} + y_3 \begin{vmatrix} y_1' & y_2' \\ y_1''' & y_2''' \end{vmatrix}.$$

The *second* line follows from the observation above. Now we find that

$$W'(y_1, y_2, y_3) = \begin{vmatrix} y_1' & y_2' & y_3' \\ y_1' & y_2' & y_3' \\ y_1'' & y_2'' & y_3'' \end{vmatrix} + \begin{vmatrix} y_1 & y_2 & y_3 \\ y_1' & y_2' & y_3' \\ y_1''' & y_2''' & y_3''' \end{vmatrix}.$$

Hence the assertion is true, since the first determinant is equal to *zero*.

(b). Based on the properties of determinants,

$$p_2(t)p_3(t)W' = \begin{vmatrix} p_3 y_1 & p_3 y_2 & p_3 y_3 \\ p_2 y_1' & p_2 y_2' & p_2 y_3' \\ y_1''' & y_2''' & y_3''' \end{vmatrix}$$

Adding the *first two* rows to the *third* row does not change the value of the determinant. Since the functions are assumed to be solutions of the given ODE, addition of the rows results in

$$p_2(t)p_3(t)W' = \begin{vmatrix} p_3 y_1 & p_3 y_2 & p_3 y_3 \\ p_2 y_1' & p_2 y_2' & p_2 y_3' \\ -p_1 y_1'' & -p_1 y_2'' & -p_1 y_3'' \end{vmatrix}.$$

It follows that  $p_2(t)p_3(t)W' = -p_1(t)p_2(t)p_3(t)W$ . As long as the coefficients are not zero, we obtain  $W' = -p_1(t)W$ .

(c). The first order equation  $W' = -p_1(t)W$  is linear, with integrating factor  $\mu(t) = \exp(\int p_1(t)dt)$ . Hence  $W(t) = c \exp(-\int p_1(t)dt)$ . Furthermore,  $W(t)$  is *zero* only if  $c = 0$ .

(d). It can be shown, by mathematical induction, that

$$W'(y_1, y_2, \dots, y_n) = \begin{vmatrix} y_1 & y_2 & \dots & y_{n-1} & y_n \\ y_1' & y_2' & \dots & y_{n-1}' & y_n' \\ \vdots & \vdots & \ddots & \vdots & \vdots \\ y_1^{(n-2)} & y_2^{(n-2)} & \dots & y_{n-1}^{(n-2)} & y_n^{(n-2)} \\ y_1^{(n)} & y_2^{(n)} & \dots & y_{n-1}^{(n)} & y_n^{(n)} \end{vmatrix}.$$

Based on the reasoning in Part(b), it follows that

$$p_2(t)p_3(t)\cdots p_n(t)W' = -p_1(t)p_2(t)p_3(t)\cdots p_n(t)W,$$

and hence  $W' = -p_1(t)W$ .

22. Inspection of the coefficients reveals that  $p_1(t) = 0$ . Based on Prob. 20, we find that  $W' = 0$ , and hence  $W = c$ .

23. After writing the equation in standard form, observe that  $p_1(t) = 2/t$ . Based on the results in Prob. 20, we find that  $W' = (-2/t)W$ , and hence  $W = c/t^2$ .

24. Writing the equation in standard form, we find that  $p_1(t) = 1/t$ . Using *Abel's formula*, the Wronskian has the form  $W(t) = c \exp(-\int \frac{1}{t} dt) = c/t$ .

25(a). Assuming that  $c_1y_1(t) + c_2y_2(t) + \cdots + c_ny_n(t) = 0$ , then taking the first  $n - 1$  derivatives of this equation results in

$$c_1y_1^{(k)}(t) + c_2y_2^{(k)}(t) + \cdots + c_ny_n^{(k)}(t) = 0$$

for  $k = 0, 1, \dots, n - 1$ . Setting  $t = t_0$ , we obtain a system of  $n$  algebraic equations with unknowns  $c_1, c_2, \dots, c_n$ . The Wronskian,  $W(y_1, y_2, \dots, y_n)(t_0)$ , is the determinant of the coefficient matrix. Since system of equations is homogeneous,  $W(y_1, y_2, \dots, y_n)(t_0) \neq 0$  implies that the only solution is the *trivial* solution,  $c_1 = c_2 = \cdots = c_n = 0$ .

(b). Suppose that  $W(y_1, y_2, \dots, y_n)(t_0) = 0$  for some  $t_0$ . Consider the system of algebraic equations

$$c_1y_1^{(k)}(t_0) + c_2y_2^{(k)}(t_0) + \cdots + c_ny_n^{(k)}(t_0) = 0,$$

$k = 0, 1, \dots, n - 1$ , with unknowns  $c_1, c_2, \dots, c_n$ . Vanishing of the Wronskian, which is the determinant of the coefficient matrix, implies that there is a *nontrivial* solution of the system of homogeneous equations. That is, there exist constants  $c_1, c_2, \dots, c_n$ , not all zero, which satisfy the above equations. Now let

$$y(t) = c_1y_1(t) + c_2y_2(t) + \cdots + c_ny_n(t).$$

Since the ODE is linear,  $y(t)$  is also a *nonzero* solution. Based on the system of algebraic equations above,  $y(t_0) = y'(t_0) = \cdots = y^{(n-1)}(t_0) = 0$ . This contradicts the uniqueness of the *identically zero* solution.

26. Let  $y(t) = y_1(t)v(t)$ . Then  $y' = y_1'v + y_1v'$ ,  $y'' = y_1''v + 2y_1'v' + y_1v''$ , and  $y''' = y_1'''v + 3y_1''v' + 3y_1'v'' + y_1v'''$ . Substitution into the ODE results in

$$y_1'''v + 3y_1''v' + 3y_1'v'' + y_1v''' + p_1[y_1''v + 2y_1'v' + y_1v''] + p_2[y_1'v + y_1v'] + p_3y_1v = 0.$$

Since  $y_1$  is assumed to be a solution, all terms containing the factor  $v(t)$  vanish. Hence

$$y_1 v''' + [p_1 y_1 + 3y_1'] v'' + [3y_1'' + 2p_1 y_1' + p_2 y_1] v' = 0,$$

which is a *second order* ODE in the variable  $u = v'$ .

28. First write the equation in standard form:

$$y''' - 3 \frac{t+2}{t(t+3)} y'' + 6 \frac{t+1}{t^2(t+3)} y' - \frac{6}{t^2(t+3)} y = 0.$$

Let  $y(t) = t^2 v(t)$ . Substitution into the given ODE results in

$$t^2 v''' + 3 \frac{t(t+4)}{t+3} v'' = 0.$$

Set  $w = v''$ . Then  $w$  is a solution of the first order differential equation

$$w' + 3 \frac{t+4}{t(t+3)} w = 0.$$

This equation is *linear*, with integrating factor  $\mu(t) = t^4/(t+3)$ . The general solution is  $w = c(t+3)/t^4$ . Integrating twice, it follows that  $v(t) = c_1 t^{-1} + c_1 t^{-2} + c_2 t + c_3$ . Hence  $y(t) = c_1 t + c_1 + c_2 t^3 + c_3 t^2$ . Finally, since  $y_1(t) = t^2$  and  $y_2(t) = t^3$  are given solutions, the *third* independent solution is  $y_3(t) = c_1 t + c_1$ .

## Section 4.2

1. The *magnitude* of  $1 + i$  is  $R = \sqrt{2}$  and the *polar angle* is  $\pi/4$ . Hence the polar form is given by  $1 + i = \sqrt{2} e^{i\pi/4}$ .
3. The *magnitude* of  $-3$  is  $R = 3$  and the *polar angle* is  $\pi$ . Hence  $-3 = 3 e^{i\pi}$ .
4. The *magnitude* of  $-i$  is  $R = 1$  and the *polar angle* is  $3\pi/2$ . Hence  $-i = e^{3\pi i/2}$ .
5. The *magnitude* of  $\sqrt{3} - i$  is  $R = 2$  and the *polar angle* is  $-\pi/6 = 11\pi/6$ . Hence the polar form is given by  $\sqrt{3} - i = 2 e^{11\pi i/6}$ .
6. The *magnitude* of  $-1 - i$  is  $R = \sqrt{2}$  and the *polar angle* is  $5\pi/4$ . Hence the polar form is given by  $-1 - i = \sqrt{2} e^{5\pi i/4}$ .
7. Writing the complex number in polar form,  $1 = e^{2m\pi i}$ , where  $m$  may be any integer. Thus  $1^{1/3} = e^{2m\pi i/3}$ . Setting  $m = 0, 1, 2$  successively, we obtain the three roots as  $1^{1/3} = 1, 1^{1/3} = e^{2\pi i/3}, 1^{1/3} = e^{4\pi i/3}$ . Equivalently, the roots can also be written as  $1, \cos(2\pi/3) + i \sin(2\pi/3) = \frac{1}{2}(-1 + \sqrt{3}i), \cos(4\pi/3) + i \sin(4\pi/3) = \frac{1}{2}(-1 - \sqrt{3}i)$ .
9. Writing the complex number in polar form,  $1 = e^{2m\pi i/4}$ , where  $m$  may be any integer. Thus  $1^{1/4} = e^{2m\pi i/4}$ . Setting  $m = 0, 1, 2, 3$  successively, we obtain the three roots as  $1^{1/4} = 1, 1^{1/4} = e^{\pi i/2}, 1^{1/4} = e^{\pi i}, 1^{1/4} = e^{3\pi i/2}$ . Equivalently, the roots can also be written as  $1, \cos(\pi/2) + i \sin(\pi/2) = i, \cos(\pi) + i \sin(\pi) = -1, \cos(3\pi/2) + i \sin(3\pi/2) = -i$ .
10. In polar form,  $2(\cos \pi/3 + i \sin \pi/3) = 2 e^{i\pi/3 + 2m\pi i}$ , in which  $m$  is any integer. Thus  $[2(\cos \pi/3 + i \sin \pi/3)]^{1/2} = 2^{1/2} e^{i\pi/6 + m\pi i}$ . With  $m = 0$ , one square root is given by  $2^{1/2} e^{i\pi/6} = (\sqrt{3} + i)/\sqrt{2}$ . With  $m = 1$ , the other root is given by  $2^{1/2} e^{i7\pi/6} = (-\sqrt{3} - i)/\sqrt{2}$ .
11. The characteristic equation is  $r^3 - r^2 - r + 1 = 0$ . The roots are  $r = -1, 1, 1$ . One root is *repeated*, hence the general solution is  $y = c_1 e^{-t} + c_2 e^t + c_3 t e^t$ .
13. The characteristic equation is  $r^3 - 2r^2 - r + 2 = 0$ , with roots  $r = -1, 1, 2$ . The roots are real and *distinct*, hence the general solution is  $y = c_1 e^{-t} + c_2 e^t + c_3 e^{2t}$ .
14. The characteristic equation can be written as  $r^2(r^2 - 4r + 4) = 0$ . The roots are  $r = 0, 0, 2, 2$ . There are two repeated roots, and hence the general solution is given by  $y = c_1 + c_2 t + c_3 e^{2t} + c_4 t e^{2t}$ .
15. The characteristic equation is  $r^6 + 1 = 0$ . The roots are given by  $r = (-1)^{1/6}$ , that is, the six *sixth roots* of  $-1$ . They are  $e^{-\pi i/6 + m\pi i/3}, m = 0, 1, \dots, 5$ . Explicitly,

$r = (\sqrt{3} - i)/2, (\sqrt{3} + i)/2, i, -i, (-\sqrt{3} + i)/2, (-\sqrt{3} - i)/2$ . Hence the general solution is given by  $y = e^{\sqrt{3}t/2}[c_1 \cos(t/2) + c_2 \sin(t/2)] + c_3 \cos t + c_4 \sin t + e^{-\sqrt{3}t/2}[c_5 \cos(t/2) + c_6 \sin(t/2)]$ .

16. The characteristic equation can be written as  $(r^2 - 1)(r^2 - 4) = 0$ . The roots are given by  $r = \pm 1, \pm 2$ . The roots are real and *distinct*, hence the general solution is  $y = c_1 e^{-t} + c_2 e^t + c_3 e^{-2t} + c_4 e^{2t}$ .

17. The characteristic equation can be written as  $(r^2 - 1)^3 = 0$ . The roots are given by  $r = \pm 1$ , each with *multiplicity three*. Hence the general solution is

$$y = c_1 e^{-t} + c_2 t e^{-t} + c_3 t^2 e^{-t} + c_4 e^t + c_5 t e^t + c_6 t^2 e^t.$$

18. The characteristic equation can be written as  $r^2(r^4 - 1) = 0$ . The roots are given by  $r = 0, 0, \pm 1, \pm i$ . The general solution is  $y = c_1 + c_2 t + c_3 e^{-t} + c_4 e^t + c_5 \cos t + c_6 \sin t$ .

19. The characteristic equation can be written as  $r(r^4 - 3r^3 + 3r^2 - 3r + 2) = 0$ . Examining the coefficients, it follows that  $r^4 - 3r^3 + 3r^2 - 3r + 2 = (r - 1)(r - 2) \times (r^2 + 1)$ . Hence the roots are  $r = 0, 1, 2, \pm i$ . The general solution of the ODE is given by  $y = c_1 + c_2 e^t + c_3 e^{2t} + c_4 \cos t + c_5 \sin t$ .

20. The characteristic equation can be written as  $r(r^3 - 8) = 0$ , with roots  $r = 0, 2 e^{2m\pi i/3}, m = 0, 1, 2$ . That is,  $r = 0, 2, -1 \pm i\sqrt{3}$ . Hence the general solution is  $y = c_1 + c_2 e^{2t} + e^{-t} [c_3 \cos \sqrt{3}t + c_4 \sin \sqrt{3}t]$ .

21. The characteristic equation can be written as  $(r^4 + 4)^2 = 0$ . The roots of the equation  $r^4 + 4 = 0$  are  $r = 1 \pm i, -1 \pm i$ . Each of these roots has *multiplicity two*. The general solution is  $y = e^t [c_1 \cos t + c_2 \sin t] + t e^t [c_3 \cos t + c_4 \sin t] + e^{-t} [c_5 \cos t + c_6 \sin t] + t e^{-t} [c_7 \cos t + c_8 \sin t]$ .

22. The characteristic equation can be written as  $(r^2 + 1)^2 = 0$ . The roots are given by  $r = \pm i$ , each with *multiplicity two*. The general solution is  $y = c_1 \cos t + c_2 \sin t + t [c_3 \cos t + c_4 \sin t]$ .

24. The characteristic equation is  $r^3 + 5r^2 + 6r + 2 = 0$ . Examining the coefficients, we find that  $r^3 + 5r^2 + 6r + 2 = (r + 1)(r^2 + 4r + 2)$ . Hence the roots are deduced as  $r = -1, -2 \pm \sqrt{2}$ . The general solution is  $y = c_1 e^{-t} + c_2 e^{(-2+\sqrt{2})t} + c_3 e^{(-2-\sqrt{2})t}$ .

25. The characteristic equation is  $18r^3 + 21r^2 + 14r + 4 = 0$ . By examining the first and last coefficients, we find that  $18r^3 + 21r^2 + 14r + 4 = (2r + 1)(9r^2 + 6r + 4)$ .

Hence the roots are  $r = -1/2, (-1 \pm \sqrt{3})/3$ . The general solution of the ODE is given by  $y = c_1 e^{-t/2} + e^{-t/3} [c_2 \cos(t/\sqrt{3}) + c_3 \sin(t/\sqrt{3})]$ .

26. The characteristic equation is  $r^4 - 7r^3 + 6r^2 + 30r - 36 = 0$ . By examining the first and last coefficients, we find that

$$r^4 - 7r^3 + 6r^2 + 30r - 36 = (r - 3)(r + 2)(r^2 - 6r + 6).$$

The roots are  $r = -2, 3, 3 \pm \sqrt{3}$ . The general solution is

$$y = c_1 e^{-2t} + c_2 e^{3t} + c_3 e^{(3-\sqrt{3})t} + c_4 e^{(3+\sqrt{3})t}.$$

28. The characteristic equation is  $r^4 + 6r^3 + 17r^2 + 22r + 14 = 0$ . It can be shown that  $r^4 + 6r^3 + 17r^2 + 22r + 14 = (r^2 + 2r + 2)(r^2 + 4r + 7)$ . Hence the roots are  $r = -1 \pm i, -2 \pm i\sqrt{3}$ . The general solution is

$$y = e^{-t} [c_1 \cos t + c_2 \sin t] + e^{-2t} [c_3 \cos \sqrt{3}t + c_4 \sin \sqrt{3}t].$$

30.  $y(t) = \frac{1}{2} e^{-t/\sqrt{2}} \sin(t/\sqrt{2}) - \frac{1}{2} e^{t/\sqrt{2}} \sin(t/\sqrt{2})$ .

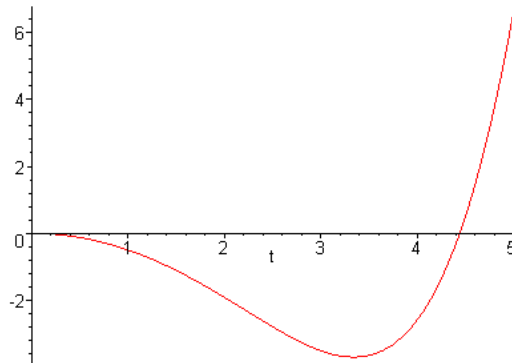

32. The characteristic equation is  $r^3 - r^2 + r - 1 = 0$ , with roots  $r = 1, \pm i$ . Hence the general solution is  $y(t) = c_1 e^t + c_2 \cos t + c_3 \sin t$ . Invoking the initial conditions, we obtain the system of equations

$$\begin{aligned} c_1 + c_2 &= 2 \\ c_1 + c_3 &= -1 \\ c_1 - c_2 &= -2 \end{aligned}$$

with solution  $c_1 = 0, c_2 = 2, c_3 = -1$ . Therefore the solution of the initial value problem is  $y(t) = 2 \cos t - \sin t$ .

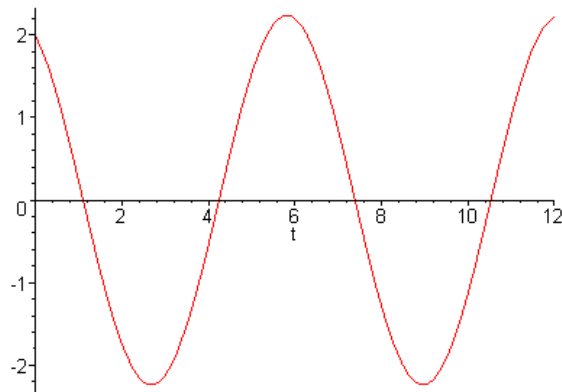

33. The characteristic equation is  $2r^4 - r^3 - 9r^2 + 4r + 4 = 0$ , with roots  $r = -1/2, 1, \pm 2$ . Hence the general solution is  $y(t) = c_1 e^{-t/2} + c_2 e^t + c_3 e^{-2t} + c_4 e^{2t}$ . Applying the initial conditions, we obtain the system of equations

$$\begin{aligned} c_1 + c_2 + c_3 + c_4 &= -2 \\ -\frac{1}{2}c_1 + c_2 - 2c_3 + 2c_4 &= 0 \\ \frac{1}{4}c_1 + c_2 + 4c_3 + 4c_4 &= -2 \\ -\frac{1}{8}c_1 + c_2 - 8c_3 + 8c_4 &= 0 \end{aligned}$$

with solution  $c_1 = -16/15, c_2 = -2/3, c_3 = -1/6, c_4 = -1/10$ . Therefore the solution of the initial value problem is  $y(t) = -\frac{16}{15}e^{-t/2} - \frac{2}{3}e^t - \frac{1}{6}e^{-2t} - \frac{1}{10}e^{2t}$ .

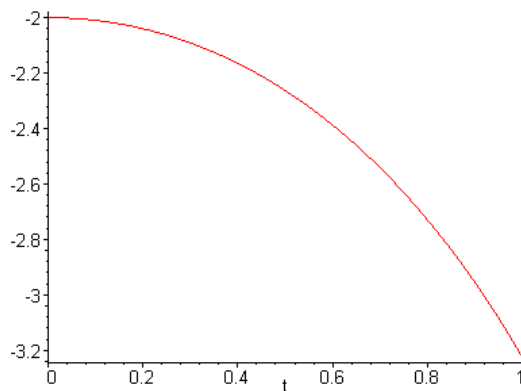

The solution decreases without bound.

34.  $y(t) = \frac{2}{13}e^{-t} + e^{t/2} \left[ \frac{24}{13} \cos t + \frac{3}{13} \sin t \right]$ .

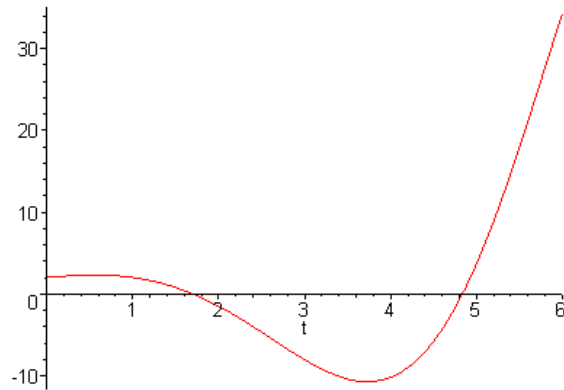

The solution is an oscillation with *increasing* amplitude.

35. The characteristic equation is  $6r^3 + 5r^2 + r = 0$ , with roots  $r = 0, -1/3, -1/2$ . The general solution is  $y(t) = c_1 + c_2e^{-t/3} + c_3e^{-t/2}$ . Invoking the initial conditions, we require that

$$\begin{aligned} c_1 + c_2 + c_3 &= -2 \\ -\frac{1}{3}c_2 - \frac{1}{2}c_3 &= 2 \\ \frac{1}{9}c_2 + \frac{1}{4}c_3 &= 0 \end{aligned}$$

with solution  $c_1 = 8, c_2 = -18, c_3 = 8$ . Therefore the solution of the initial value problem is  $y(t) = 8 - 18e^{-t/3} + 8e^{-t/2}$ .

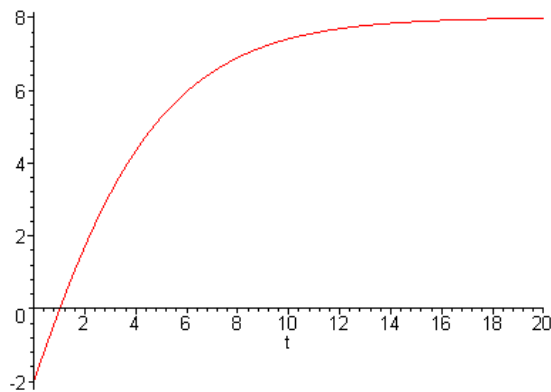

36. The general solution is derived in Prob.(28) as

$$y(t) = e^{-t}[c_1 \cos t + c_2 \sin t] + e^{-2t}[c_3 \cos \sqrt{3}t + c_4 \sin \sqrt{3}t].$$

Invoking the initial conditions, we obtain the system of equations



$$\begin{aligned}
 c_1 + c_3 &= 1 \\
 -c_1 + c_2 - 2c_3 + \sqrt{3}c_4 &= -2 \\
 -2c_2 + c_3 - 4\sqrt{3}c_4 &= 0 \\
 2c_1 + 2c_2 + 10c_3 + 9\sqrt{3}c_4 &= 3
 \end{aligned}$$

with solution  $c_1 = 21/13$ ,  $c_2 = -38/13$ ,  $c_3 = -8/13$ ,  $c_4 = 17\sqrt{3}/39$ .

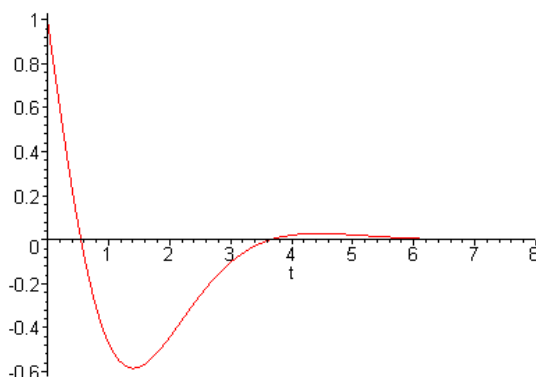

The solution is a rapidly-decaying oscillation.

38.

$$\begin{aligned}
 W(e^t, e^{-t}, \cos t, \sin t) &= -8 \\
 W(\cosh t, \sinh t, \cos t, \sin t) &= 4
 \end{aligned}$$

40. Suppose that  $c_1e^{r_1t} + c_2e^{r_2t} + \dots + c_n e^{r_nt} = 0$ , and each of the  $r_k$  are real and different. Multiplying this equation by  $e^{-r_1t}$ ,  $c_1 + c_2e^{(r_2-r_1)t} + \dots + c_n e^{(r_n-r_1)t} = 0$ . Differentiation results in

$$c_2(r_2 - r_1)e^{(r_2-r_1)t} + \dots + c_n(r_n - r_1)e^{(r_n-r_1)t} = 0.$$

Now multiplying the latter equation by  $e^{-(r_2-r_1)t}$ , and differentiating, we obtain

$$c_3(r_3 - r_2)(r_3 - r_1)e^{(r_3-r_2)t} + \dots + c_n(r_n - r_2)(r_n - r_1)e^{(r_n-r_2)t} = 0.$$

Following the above steps in a similar manner, it follows that

$$c_n(r_n - r_{n-1}) \dots (r_n - r_1)e^{(r_n-r_{n-1})t} = 0.$$

Since these equations hold for all  $t$ , and all the  $r_k$  are different, we have  $c_n = 0$ . Hence

$$c_1e^{r_1t} + c_2e^{r_2t} + \dots + c_{n-1}e^{r_{n-1}t} = 0, \quad -\infty < t < \infty.$$

The same procedure can now be repeated, successively, to show that

$$c_1 = c_2 = \dots = c_n = 0.$$

## Section 4.3

2. The general solution of the homogeneous equation is  $y_c = c_1 e^t + c_2 e^{-t} + c_3 \cos t + c_4 \sin t$ . Let  $g_1(t) = 3t$  and  $g_2(t) = \cos t$ . By inspection, we find that  $Y_1(t) = -3t$ . Since  $g_2(t)$  is a solution of the homogeneous equation, set  $Y_2(t) = t(A \cos t + B \sin t)$ . Substitution into the given ODE and comparing the coefficients of similar term results in  $A = 0$  and  $B = -1/4$ . Hence the general solution of the nonhomogeneous problem is

$$y(t) = y_c(t) - 3t - \frac{t}{4} \sin t.$$

3. The characteristic equation corresponding to the homogeneous problem can be written as  $(r+1)(r^2+1) = 0$ . The solution of the homogeneous equation is  $y_c = c_1 e^{-t} + c_2 \cos t + c_3 \sin t$ . Let  $g_1(t) = e^{-t}$  and  $g_2(t) = 4t$ . Since  $g_1(t)$  is a solution of the homogeneous equation, set  $Y_1(t) = A t e^{-t}$ . Substitution into the ODE results in  $A = 1/2$ . Now let  $Y_2(t) = B t + C$ . We find that  $B = -C = 4$ . Hence the general solution of the nonhomogeneous problem is  $y(t) = y_c(t) + t e^{-t}/2 + 4(t-1)$ .

4. The characteristic equation corresponding to the homogeneous problem can be written as  $r(r+1)(r-1) = 0$ . The solution of the homogeneous equation is  $y_c = c_1 + c_2 e^t + c_3 e^{-t}$ . Since  $g(t) = 2 \sin t$  is not a solution of the homogeneous problem, we can set  $Y(t) = A \cos t + B \sin t$ . Substitution into the ODE results in  $A = 1$  and  $B = 0$ .

Thus

the general solution is  $y(t) = c_1 + c_2 e^t + c_3 e^{-t} + \cos t$ .

6. The characteristic equation corresponding to the homogeneous problem can be written as  $(r^2+1)^2 = 0$ . It follows that  $y_c = c_1 \cos t + c_2 \sin t + t(c_3 \cos t + c_4 \sin t)$ . Since  $g(t)$  is not a solution of the homogeneous problem, set  $Y(t) = A + B \cos 2t + C \sin 2t$ . Substitution into the ODE results in  $A = 3$ ,  $B = 1/9$ ,  $C = 0$ . Thus the general solution is  $y(t) = y_c(t) + 3 + \frac{1}{9} \cos 2t$ .

7. The characteristic equation corresponding to the homogeneous problem can be written as  $r^3(r^3+1) = 0$ . Thus the homogeneous solution is

$$y_c = c_1 + c_2 t + c_3 t^2 + c_4 e^{-t} + e^{t/2} \left[ c_5 \cos(\sqrt{3} t/2) + c_6 \sin(\sqrt{3} t/2) \right].$$

Note the  $g(t) = t$  is a solution of the homogeneous problem. Consider a particular solution

of the form  $Y(t) = t^3(A t + B)$ . Substitution into the ODE results in  $A = 1/24$  and  $B = 0$ . Thus the general solution is  $y(t) = y_c(t) + t^4/24$ .

8. The characteristic equation corresponding to the homogeneous problem can be written as  $r^3(r+1) = 0$ . Hence the homogeneous solution is  $y_c = c_1 + c_2 t + c_3 t^2 + c_4 e^{-t}$ . Since  $g(t)$  is not a solution of the homogeneous problem, set  $Y(t) = A \cos 2t + B \sin 2t$ . Substitution into the ODE results in  $A = 1/40$  and  $B = 1/20$ . Thus the general solution

is  $y(t) = y_c(t) + (\cos 2t + 2\sin 2t)/40$ .

10. From Prob. 22 in Section 4.2, the homogeneous solution is

$$y_c = c_1 \cos t + c_2 \sin t + t[c_3 \cos t + c_4 \sin t].$$

Since  $g(t)$  is *not* a solution of the homogeneous problem, substitute  $Y(t) = At + B$  into the ODE to obtain  $A = 3$  and  $B = 4$ . Thus the general solution is  $y(t) = y_c(t) + 3t + 4$ . Invoking the initial conditions, we find that  $c_1 = -4$ ,  $c_2 = -4$ ,  $c_3 = 1$ ,  $c_4 = -3/2$ . Therefore the solution of the initial value problem is

$$y(t) = (t - 4)\cos t - (3t/2 + 4)\sin t + 3t + 4.$$

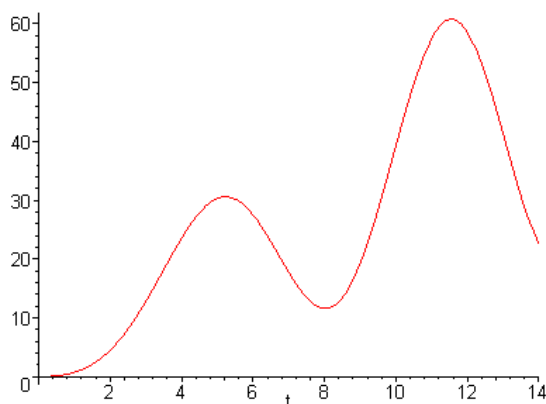

11. The characteristic equation can be written as  $r(r^2 - 3r + 2) = 0$ . Hence the homogeneous solution is  $y_c = c_1 + c_2 e^t + c_3 e^{2t}$ . Let  $g_1(t) = e^t$  and  $g_2(t) = t$ . Note that  $g_1$  is a solution of the homogeneous problem. Set  $Y_1(t) = Ate^t$ . Substitution into the ODE results in  $A = -1$ . Now let  $Y_2(t) = Bt^2 + Ct$ . Substitution into the ODE results in  $B = 1/4$  and  $C = 3/4$ . Therefore the general solution is

$$y(t) = c_1 + c_2 e^t + c_3 e^{2t} - te^t + (t^2 + 3t)/4.$$

Invoking the initial conditions, we find that  $c_1 = 1$ ,  $c_2 = c_3 = 0$ . The solution of the initial value problem is  $y(t) = 1 - te^t + (t^2 + 3t)/4$ .

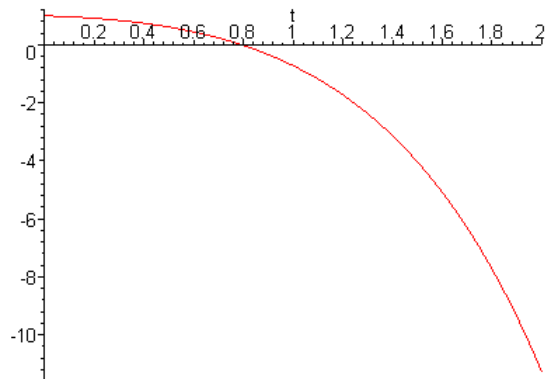

12. The characteristic equation can be written as  $(r - 1)(r + 3)(r^2 + 4) = 0$ . Hence the homogeneous solution is  $y_c = c_1 e^t + c_2 e^{-3t} + c_3 \cos 2t + c_4 \sin 2t$ . None of the terms in  $g(t)$  is a solution of the homogeneous problem. Therefore we can assume a form  $Y(t) = Ae^{-t} + B \cos t + C \sin t$ . Substitution into the ODE results in  $A = 1/20$ ,  $B = -2/5$ ,  $C = -4/5$ . Hence the general solution is

$$y(t) = c_1 e^t + c_2 e^{-3t} + c_3 \cos 2t + c_4 \sin 2t + e^{-t}/20 - (2 \cos t + 4 \sin t)/5.$$

Invoking the initial conditions, we find that  $c_1 = 81/40$ ,  $c_2 = 73/520$ ,  $c_3 = 77/65$ ,  $c_4 = -49/130$ .

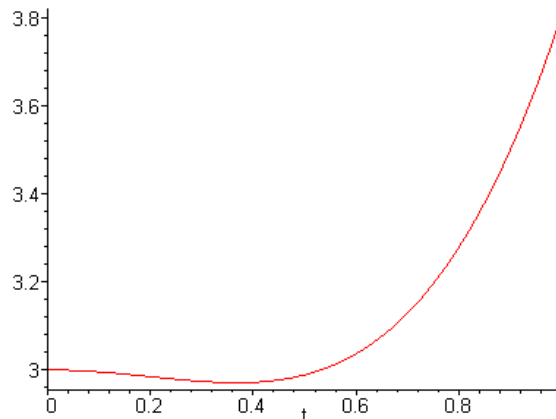

14. From Prob. 4, the homogeneous solution is  $y_c = c_1 + c_2 e^t + c_3 e^{-t}$ . Consider the terms  $g_1(t) = t e^{-t}$  and  $g_2(t) = 2 \cos t$ . Note that since  $r = -1$  is a *simple* root of the characteristic equation, Table 4.3.1 suggests that we set  $Y_1(t) = t(At + B)e^{-t}$ . The function  $2 \cos t$  is *not* a solution of the homogeneous equation. We can simply choose  $Y_2(t) = C \cos t + D \sin t$ . Hence the particular solution has the form

$$Y(t) = t(At + B)e^{-t} + C \cos t + D \sin t.$$

15. The characteristic equation can be written as  $(r^2 - 1)^2 = 0$ . The roots are given

as  $r = \pm 1$ , each with *multiplicity two*. Hence the solution of the homogeneous problem is  $y_c = c_1 e^t + c_2 t e^t + c_3 e^{-t} + c_4 t e^{-t}$ . Let  $g_1(t) = e^t$  and  $g_2(t) = \sin t$ . The function  $e^t$  is a solution of the homogeneous problem. Since  $r = 1$  has *multiplicity two*, we set  $Y_1(t) = At^2 e^t$ . The function  $\sin t$  is *not* a solution of the homogeneous equation. We can set  $Y_2(t) = B \cos t + C \sin t$ . Hence the particular solution has the form

$$Y(t) = At^2 e^t + B \cos t + C \sin t.$$

16. The characteristic equation can be written as  $r^2(r^2 + 4) = 0$ , with roots  $r = 0, \pm 2i$ . The root  $r = 0$  has *multiplicity two*, hence the homogeneous solution is  $y_c = c_1 + c_2 t + c_3 \cos 2t + c_4 \sin 2t$ . The functions  $g_1(t) = \sin 2t$  and  $g_2(t) = 4$  are solutions of the homogeneous equation. The complex roots have *multiplicity one*, therefore we need to set  $Y_1(t) = At \cos 2t + Bt \sin 2t$ . Now  $g_2(t) = 4$  is associated with the *double* root  $r = 0$ . Based on Table 4.3.1, set  $Y_2(t) = Ct^2$ . Finally,  $g_3(t) = te^t$  (and its derivatives) is independent of the homogeneous solution. Therefore set  $Y_3(t) = (Dt + E)e^t$ . Conclude that the particular solution has the form

$$Y(t) = At \cos 2t + Bt \sin 2t + Ct^2 + (Dt + E)e^t.$$

18. The characteristic equation can be written as  $r^2(r^2 + 2r + 2) = 0$ , with roots  $r = 0$ , with *multiplicity two*, and  $r = -1 \pm i$ . The homogeneous solution is  $y_c = c_1 + c_2 t + c_3 e^{-t} \cos t + c_4 e^{-t} \sin t$ . The function  $g_1(t) = 3e^t + 2te^{-t}$ , and all of its derivatives, is independent of the homogeneous solution. Therefore set  $Y_1(t) = Ae^t + (Bt + C)e^{-t}$ . Now  $g_2(t) = e^{-t} \sin t$  is a solution of the homogeneous equation, associated with the complex roots. We need to set  $Y_2(t) = t(D e^{-t} \cos t + E e^{-t} \sin t)$ . It follows that the particular solution has the form

$$Y(t) = Ae^t + (Bt + C)e^{-t} + t(D e^{-t} \cos t + E e^{-t} \sin t).$$

19. Differentiating  $y = u(t)v(t)$ , successively, we have

$$\begin{aligned} y' &= u'v + uv' \\ y'' &= u''v + 2u'v' + uv'' \\ &\vdots \\ y^{(n)} &= \sum_{j=0}^n \binom{n}{j} u^{(n-j)} v^{(j)} \end{aligned}$$

Setting  $v(t) = e^{\alpha t}$ ,  $v^{(j)} = \alpha^j e^{\alpha t}$ . So for any  $p = 1, 2, \dots, n$ ,

$$y^{(p)} = e^{\alpha t} \sum_{j=0}^p \binom{p}{j} \alpha^j u^{(p-j)}.$$

It follows that

$$L[e^{\alpha t}u] = e^{\alpha t} \sum_{p=0}^n \left[ a_{n-p} \sum_{j=0}^p \binom{p}{j} \alpha^j u^{(p-j)} \right] \quad (*).$$

It is evident that the right hand side of Eq. (\*) is of the form

$$e^{\alpha t} [k_0 u^{(n)} + k_1 u^{(n-1)} + \cdots + k_{n-1} u' + k_n u].$$

Hence operator equation  $L[e^{\alpha t}u] = e^{\alpha t}(b_0 t^m + b_1 t^{m-1} + \cdots + b_{m-1}t + b_m)$  can be written as

$$\begin{aligned} k_0 u^{(n)} + k_1 u^{(n-1)} + \cdots + k_{n-1} u' + k_n u &= \\ &= b_0 t^m + b_1 t^{m-1} + \cdots + b_{m-1}t + b_m. \end{aligned}$$

The coefficients  $k_i, i = 0, 1, \dots, n$  can be determined by collecting the like terms in the double summation in Eq. (\*). For example,  $k_0$  is the coefficient of  $u^{(n)}$ . The *only* term that contains  $u^{(n)}$  is when  $p = n$  and  $j = 0$ . Hence  $k_0 = a_0$ . On the other hand,  $k_n$  is the coefficient of  $u(t)$ . The inner summation in (\*) contains terms with  $u$ , given by  $\alpha^p u$  (when  $j = p$ ), for each  $p = 0, 1, \dots, n$ . Hence

$$k_n = \sum_{p=0}^n a_{n-p} \alpha^p.$$

21(a). Clearly,  $e^{2t}$  is a solution of  $y' - 2y = 0$ , and  $te^{-t}$  is a solution of the differential equation  $y'' + 2y' + y = 0$ . The latter ODE has characteristic equation  $(r + 1)^2 = 0$ . Hence  $(D - 2)[3e^{2t}] = 3(D - 2)[e^{2t}] = 0$  and  $(D + 1)^2[te^{-t}] = 0$ . Furthermore, we have  $(D - 2)(D + 1)^2[te^{-t}] = (D - 2)[0] = 0$ , and  $(D - 2)(D + 1)^2[3e^{2t}] = (D + 1)^2(D - 2)[3e^{2t}] = (D + 1)^2[0] = 0$ .

(b). Based on Part (a),

$$\begin{aligned} (D - 2)(D + 1)^2[(D - 2)^3(D + 1)Y] &= (D - 2)(D + 1)^2[3e^{2t} - te^{-t}] \\ &= 0, \end{aligned}$$

since the operators are linear. The implied operations are associative and commutative. Hence

$$(D - 2)^4(D + 1)^3Y = 0.$$

The operator equation corresponds to the solution of a linear homogeneous ODE with characteristic equation  $(r - 2)^4(r + 1)^3 = 0$ . The roots are  $r = 2$ , with multiplicity 4 and  $r = -1$ , with multiplicity 3. It follows that the given homogeneous solution is

$$Y(t) = c_1 e^{2t} + c_2 t e^{2t} + c_3 t^2 e^{2t} + c_4 t^3 e^{2t} + c_5 e^{-t} + c_6 t e^{-t} + c_7 t^2 e^{-t},$$

which is a linear combination of seven independent solutions.

22(15). Observe that  $(D - 1)[e^t] = 0$  and  $(D^2 + 1)[\sin t] = 0$ . Hence the operator  $H(D) = (D - 1)(D^2 + 1)$  is an annihilator of  $e^t + \sin t$ . The operator corresponding to the left hand side of the given ODE is  $(D^2 - 1)^2$ . It follows that

$$(D + 1)^2(D - 1)^3(D^2 + 1)Y = 0.$$

The resulting ODE is homogeneous, with solution

$$Y(t) = c_1e^{-t} + c_2te^{-t} + c_3e^t + c_4te^t + c_5t^3e^t + c_6\cos t + c_7\sin t.$$

After examining the homogeneous solution of Prob. 15, and eliminating duplicate terms, we have

$$Y(t) = c_5t^3e^t + c_6\cos t + c_7\sin t.$$

22(16). We find that  $D[4] = 0$ ,  $(D - 1)^2[te^t] = 0$ , and  $(D^2 + 4)[\sin 2t] = 0$ . The operator  $H(D) = D(D - 1)^2(D^2 + 4)$  is an annihilator of  $t^2 + te^t + \sin 2t$ . The operator corresponding to the left hand side of the ODE is  $D^2(D^2 + 4)$ . It follows that

$$D^3(D - 1)^2(D^2 + 4)^2Y = 0.$$

The resulting ODE is homogeneous, with solution

$$Y(t) = c_1 + c_2t + c_3t^2 + c_4e^t + c_5te^t + c_6\cos 2t + c_7\sin 2t + c_8t\cos 2t + c_9t\sin 2t.$$

After examining the homogeneous solution of Prob. 16, and eliminating duplicate terms, we have

$$Y(t) = c_3t^2 + c_4e^t + c_5te^t + c_8t\cos 2t + c_9t\sin 2t.$$

22(18). Observe that  $(D - 1)[e^t] = 0$ ,  $(D + 1)^2[te^{-t}] = 0$ . The function  $e^{-t}\sin t$  is a solution of a second order ODE with characteristic roots  $r = -1 \pm i$ . It follows that  $(D^2 + 2D + 2)[e^{-t}\sin t] = 0$ . Therefore the operator

$$H(D) = (D - 1)(D + 1)^2(D^2 + 2D + 2)$$

is an annihilator of  $3e^t + 2te^{-t} + e^{-t}\sin t$ . The operator corresponding to the left hand side of the given ODE is  $D^2(D^2 + 2D + 2)$ . It follows that

$$D^2(D - 1)(D + 1)^2(D^2 + 2D + 2)^2Y = 0.$$

The resulting ODE is homogeneous, with solution

$$Y(t) = c_1 + c_2t + c_3e^t + c_4e^{-t} + c_5te^{-t} + e^{-t}(c_6\cos t + c_7\sin t) + te^{-t}(c_8\cos t + c_9\sin t).$$

After examining the homogeneous solution of Prob. 18, and eliminating duplicate terms,

we have

$$Y(t) = c_3 e^t + c_4 e^{-t} + c_5 t e^{-t} + t e^{-t} (c_8 \cos t + c_9 \sin t).$$



## Section 4.4

2. The characteristic equation is  $r(r^2 - 1) = 0$ . Hence the homogeneous solution is  $y_c(t) = c_1 + c_2e^t + c_3e^{-t}$ . The Wronskian is evaluated as  $W(1, e^t, e^{-t}) = 2$ . Now compute the three determinants

$$W_1(t) = \begin{vmatrix} 0 & e^t & e^{-t} \\ 0 & e^t & -e^{-t} \\ 1 & e^t & e^{-t} \end{vmatrix} = -2$$

$$W_2(t) = \begin{vmatrix} 1 & 0 & e^{-t} \\ 0 & 0 & -e^{-t} \\ 0 & 1 & e^{-t} \end{vmatrix} = e^{-t}$$

$$W_3(t) = \begin{vmatrix} 1 & e^t & 0 \\ 0 & e^t & 0 \\ 0 & e^t & 1 \end{vmatrix} = e^t$$

The solution of the system of equations (10) is

$$u_1'(t) = \frac{t W_1(t)}{W(t)} = -t$$

$$u_2'(t) = \frac{t W_2(t)}{W(t)} = te^{-t}/2$$

$$u_3'(t) = \frac{t W_3(t)}{W(t)} = te^t/2$$

Hence  $u_1(t) = -t^2/2$ ,  $u_2(t) = -e^{-t}(t+1)/2$ ,  $u_3(t) = e^t(t-1)/2$ . The particular solution becomes  $Y(t) = -t^2/2 - (t+1)/2 + (t-1)/2 = -t^2/2 - 1$ . The constant is a solution of the homogeneous equation, therefore the general solution is

$$y(t) = c_1 + c_2e^t + c_3e^{-t} - t^2/2.$$

3. From Prob. 13 in Section 4.2,  $y_c(t) = c_1e^{-t} + c_2e^t + c_3e^{2t}$ . The Wronskian is evaluated as  $W(e^{-t}, e^t, e^{2t}) = 6e^{2t}$ . Now compute the three determinants

$$W_1(t) = \begin{vmatrix} 0 & e^t & e^{2t} \\ 0 & e^t & 2e^{2t} \\ 1 & e^t & 4e^{2t} \end{vmatrix} = e^{3t}$$

$$W_2(t) = \begin{vmatrix} e^{-t} & 0 & e^{2t} \\ -e^{-t} & 0 & 2e^{2t} \\ e^{-t} & 1 & 4e^{2t} \end{vmatrix} = -3e^t$$

$$W_3(t) = \begin{vmatrix} e^{-t} & e^t & 0 \\ -e^{-t} & e^t & 0 \\ e^{-t} & e^t & 1 \end{vmatrix} = 2$$

Hence  $u_1'(t) = e^{5t}/6$ ,  $u_2'(t) = -e^{3t}/2$ ,  $u_3'(t) = e^{2t}/3$ . Therefore the particular solution can be expressed as

$$\begin{aligned} Y(t) &= e^{-t}[e^{5t}/30] - e^t[e^{3t}/6] + e^{2t}[e^{2t}/6] \\ &= e^{4t}/30. \end{aligned}$$

6. From Prob. 22 in Section 4.2,  $y_c(t) = c_1 \cos t + c_2 \sin t + t[c_3 \cos t + c_4 \sin t]$ . The Wronskian is evaluated as  $W(\cos t, \sin t, t \cos t, t \sin t) = 4$ . Now compute the four auxiliary determinants

$$W_1(t) = \begin{vmatrix} 0 & \sin t & t \cos t & t \sin t \\ 0 & \cos t & \cos t - t \sin t & \sin t + t \cos t \\ 0 & -\sin t & -2\sin t - t \cos t & 2\cos t - t \sin t \\ 1 & -\cos t & -3\cos t + t \sin t & -3\sin t - t \cos t \end{vmatrix} = -2\sin t + 2t \cos t$$

$$W_2(t) = \begin{vmatrix} \cos t & 0 & t \cos t & t \sin t \\ -\sin t & 0 & \cos t - t \sin t & \sin t + t \cos t \\ -\cos t & 0 & -2\sin t - t \cos t & 2\cos t - t \sin t \\ \sin t & 1 & -3\cos t + t \sin t & -3\sin t - t \cos t \end{vmatrix} = 2t \sin t + 2\cos t$$

$$W_3(t) = \begin{vmatrix} \cos t & \sin t & 0 & t \sin t \\ -\sin t & \cos t & 0 & \sin t + t \cos t \\ -\cos t & -\sin t & 0 & 2\cos t - t \sin t \\ \sin t & -\cos t & 1 & -3\sin t - t \cos t \end{vmatrix} = -2\cos t$$

$$W_4(t) = \begin{vmatrix} \cos t & \sin t & t \cos t & 0 \\ -\sin t & \cos t & \cos t - t \sin t & 0 \\ -\cos t & -\sin t & -2\sin t - t \cos t & 0 \\ \sin t & -\cos t & -3\cos t + t \sin t & 1 \end{vmatrix} = -2\sin t$$

It follows that  $u_1'(t) = [-\sin^2 t + t \sin t \cos t]/2$ ,  $u_2'(t) = [t \sin^2 t + \sin t \cos t]/2$ ,  $u_3'(t) = -\sin t \cos t/2$ ,  $u_4'(t) = -\sin^2 t/2$ . Hence

$$u_1(t) = [3\sin t \cos t - 2t \cos^2 t - t]/8$$

$$u_2(t) = [\sin^2 t - 2\cos^2 t - 2t \sin t \cos t + t^2]/8$$

$$u_3(t) = -\sin^2 t/4$$

$$u_4(t) = [\cos t \sin t - t]/4$$

Therefore the particular solution can be expressed as

$$\begin{aligned} Y(t) &= \cos t [u_1(t)] + \sin t [u_2(t)] + t \cos t [u_3(t)] + t \sin t [u_4(t)] \\ &= [\sin t - 3t \cos t - t^2 \sin t]/8. \end{aligned}$$

Note that only the *last term* is not a solution of the homogeneous equation. Hence the general solution is

$$y(t) = c_1 \cos t + c_2 \sin t + t[c_3 \cos t + c_4 \sin t] - t^2 \sin t / 8.$$

8. Based on the results in Prob. 2,  $y_c(t) = c_1 + c_2 e^t + c_3 e^{-t}$ . It was also shown that  $W(1, e^t, e^{-t}) = 2$ , with  $W_1(t) = -2$ ,  $W_2(t) = e^{-t}$ ,  $W_3(t) = e^t$ . Therefore we have  $u_1'(t) = -\csc t$ ,  $u_2'(t) = e^{-t} \csc t / 2$ ,  $u_3'(t) = e^t \csc t / 2$ . The particular solution can be expressed as  $Y(t) = [u_1(t)] + e^{-t}[u_2(t)] + e^t [u_3(t)]$ . More specifically,

$$\begin{aligned} Y(t) &= \ln|\csc(t) + \cot(t)| + \frac{e^t}{2} \int_{t_0}^t e^{-s} \csc(s) ds + \frac{e^{-t}}{2} \int_{t_0}^t e^s \csc(s) ds \\ &= \ln|\csc(t) + \cot(t)| + \int_{t_0}^t \cosh(t-s) \csc(s) ds. \end{aligned}$$

9. Based on Prob. 4,  $u_1'(t) = \sec t$ ,  $u_2'(t) = -1$ ,  $u_3'(t) = -\tan t$ . The particular solution can be expressed as  $Y(t) = [u_1(t)] + \cos t [u_2(t)] + \sin t [u_3(t)]$ . That is,

$$Y(t) = \ln|\sec(t) + \tan(t)| - t \cos t + \sin t \ln|\cos(t)|.$$

Hence the general solution of the initial value problem is

$$y(t) = c_1 + c_2 \cos t + c_3 \sin t + \ln|\sec(t) + \tan(t)| - t \cos t + \sin t \ln|\cos(t)|.$$

Invoking the initial conditions, we require that  $c_1 + c_2 = 2$ ,  $c_3 = 1$ ,  $-c_2 = -2$ . Therefore

$$y(t) = 2 \cos t + \sin t + \ln|\sec(t) + \tan(t)| - t \cos t + \sin t \ln|\cos(t)|$$

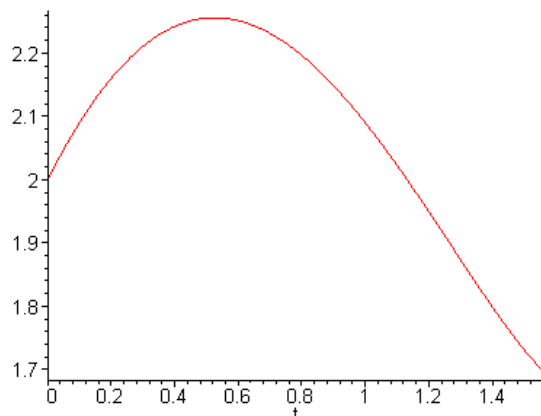

10. From Prob. 6,  $y(t) = c_1 \cos t + c_2 \sin t + c_3 t \cos t + c_4 t \sin t - t^2 \sin t / 8$ . In order to satisfy the initial conditions, we require that  $c_1 = 2$ ,  $c_2 + c_3 = 0$ ,  $-c_1 + 2c_4 = -1$ ,  $-3/4 - c_2 - 3c_3 = 1$ . Therefore

$$y(t) = 2 \cos t + [7 \sin t - 7t \cos t + 4t \sin t - t^2 \sin t] / 8.$$

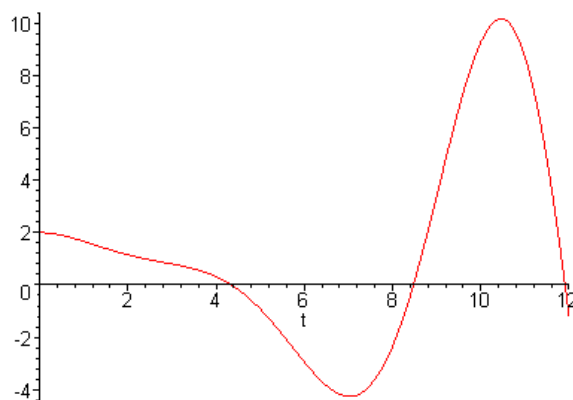

12. From Prob. 8, the general solution of the initial value problem is

$$y(t) = c_1 + c_2 e^t + c_3 e^{-t} + \ln|\csc(t) + \cot(t)| + \frac{e^t}{2} \int_{t_0}^t e^{-s} \csc(s) ds + \frac{e^{-t}}{2} \int_{t_0}^t e^s \csc(s) ds.$$

In this case,  $t_0 = \pi/2$ . Observe that  $y(\pi/2) = y_c(\pi/2)$ ,  $y'(\pi/2) = y'_c(\pi/2)$ , and  $y''(\pi/2) = y''_c(\pi/2)$ . Therefore we obtain the system of equations

$$\begin{aligned} c_1 + c_2 e^{\pi/2} + c_3 e^{-\pi/2} &= 2 \\ c_2 e^{\pi/2} - c_3 e^{-\pi/2} &= 1 \\ c_2 e^{\pi/2} + c_3 e^{-\pi/2} &= -1 \end{aligned}$$

Hence the solution of the initial value problem is

$$y(t) = 3 - e^{-t+\pi/2} + \ln|\csc(t) + \cot(t)| + \int_{t_0}^t \cosh(t-s)\csc(s)ds.$$

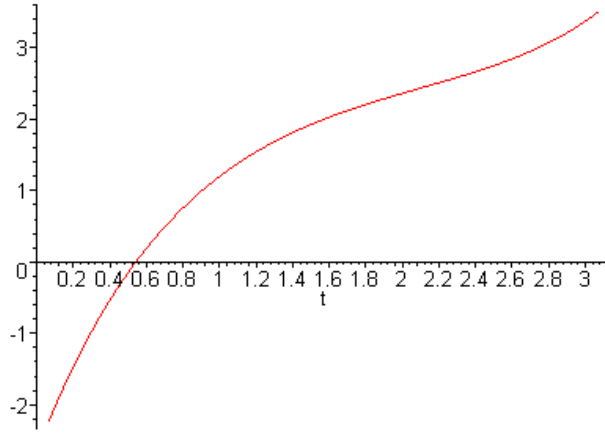

13. First write the equation as  $y''' + x^{-1}y'' - 2x^{-2}y' + 2x^{-3}y = 2x$ . The Wronskian is evaluated as  $W(x, x^2, 1/x) = 6/x$ . Now compute the three determinants

$$W_1(x) = \begin{vmatrix} 0 & x^2 & 1/x \\ 0 & 2x & -1/x^2 \\ 1 & 2 & 2/x^3 \end{vmatrix} = -3$$

$$W_2(x) = \begin{vmatrix} x & 0 & 1/x \\ 1 & 0 & -1/x^2 \\ 0 & 1 & 2/x^3 \end{vmatrix} = 2/x$$

$$W_3(x) = \begin{vmatrix} x & x^2 & 0 \\ 1 & 2x & 0 \\ 0 & 2 & 1 \end{vmatrix} = x^2$$

Hence  $u_1'(x) = -x^2$ ,  $u_2'(x) = 2x/3$ ,  $u_3'(x) = x^4/3$ . Therefore the particular solution can be expressed as

$$\begin{aligned} Y(x) &= x[-x^3/3] + x^2[x^2/3] + \frac{1}{x}[x^5/15] \\ &= x^4/15. \end{aligned}$$

15. The homogeneous solution is  $y_c(t) = c_1 \cos t + c_2 \sin t + c_3 \cosh t + c_4 \sinh t$ . The Wronskian is evaluated as  $W(\cos t, \sin t, \cosh t, \sinh t) = 4$ . Now the four additional determinants are given by  $W_1(t) = 2 \sin t$ ,  $W_2(t) = -2 \cos t$ ,  $W_3(t) = -2 \sinh t$ ,  $W_4(t) = 2 \cosh t$ . It follows that  $u_1'(t) = g(t) \sin(t)/2$ ,  $u_2'(t) = -g(t) \cos(t)/2$ ,  $u_3'(t) = -g(t) \sinh(t)/2$ ,  $u_4'(t) = g(t) \cosh(t)/2$ . Therefore the particular solution

can be expressed as

$$Y(t) = \frac{\cos(t)}{2} \int_{t_0}^t g(s) \sin(s) ds - \frac{\sin(t)}{2} \int_{t_0}^t g(s) \cos(s) ds - \\ - \frac{\cosh(t)}{2} \int_{t_0}^t g(s) \sinh(s) ds + \frac{\sinh(t)}{2} \int_{t_0}^t g(s) \cosh(s) ds.$$

Using the appropriate identities, the integrals can be combined to obtain

$$Y(t) = \frac{1}{2} \int_{t_0}^t g(s) \sinh(t-s) ds - \frac{1}{2} \int_{t_0}^t g(s) \sin(t-s) ds.$$

17. First write the equation as  $y''' - 3x^{-1}y'' + 6x^{-2}y' - 6x^{-3}y = g(x)/x^3$ . It can be shown that  $y_c(x) = c_1x + c_2x^2 + c_3x^3$  is a solution of the homogeneous equation. The Wronskian of this fundamental set of solutions is  $W(x, x^2, x^3) = 2x^3$ . The three additional determinants are given by  $W_1(x) = x^4$ ,  $W_2(x) = -2x^3$ ,  $W_3(x) = x^2$ . Hence  $u_1'(x) = g(x)/2x^2$ ,  $u_2'(x) = -g(x)/x^3$ ,  $u_3'(x) = g(x)/2x^4$ . Therefore the particular solution can be expressed as

$$Y(x) = x \int_{x_0}^x \frac{g(t)}{2t^2} dt - x^2 \int_{x_0}^x \frac{g(t)}{t^3} dt + x^3 \int_{x_0}^x \frac{g(t)}{2t^4} dt \\ = \frac{1}{2} \int_{x_0}^x \left[ \frac{x}{t^2} - \frac{2x^2}{t^3} + \frac{x^3}{t^4} \right] g(t) dt.$$

## Chapter Five

### Section 5.1

1. Apply the ratio test :

$$\lim_{n \rightarrow \infty} \frac{|(x-3)^{n+1}|}{|(x-3)^n|} = \lim_{n \rightarrow \infty} |x-3| = |x-3|.$$

Hence the series converges absolutely for  $|x-3| < 1$ . The radius of convergence is  $\rho = 1$ . The series diverges for  $x = 2$  and  $x = 4$ , since the  $n$ -th term does not approach zero.

3. Applying the ratio test,

$$\lim_{n \rightarrow \infty} \frac{|n! x^{2n+2}|}{|(n+1)! x^{2n}|} = \lim_{n \rightarrow \infty} \frac{x^2}{n+1} = 0.$$

The series converges absolutely for *all* values of  $x$ . Thus the radius of convergence is  $\rho = \infty$ .

4. Apply the ratio test :

$$\lim_{n \rightarrow \infty} \frac{|2^{n+1} x^{n+1}|}{|2^n x^n|} = \lim_{n \rightarrow \infty} 2|x| = 2|x|.$$

Hence the series converges absolutely for  $2|x|$ , or  $|x| < 1/2$ . The radius of convergence is  $\rho = 1/2$ . The series diverges for  $x = \pm 1/2$ , since the  $n$ -th term does not approach zero.

6. Applying the ratio test,

$$\lim_{n \rightarrow \infty} \frac{|n(x-x_0)^{n+1}|}{|(n+1)(x-x_0)^n|} = \lim_{n \rightarrow \infty} \frac{n}{n+1} |(x-x_0)| = |(x-x_0)|.$$

Hence the series converges absolutely for  $|(x-x_0)| < 1$ . The radius of convergence is  $\rho = 1$ . At  $x = x_0 + 1$ , we obtain the *harmonic series*, which is *divergent*. At the other endpoint,  $x = x_0 - 1$ , we obtain

$$\sum_{n=1}^{\infty} \frac{(-1)^n}{n},$$

which is *conditionally* convergent.

7. Apply the ratio test :

$$\lim_{n \rightarrow \infty} \frac{|3^n(n+1)^2(x+2)^{n+1}|}{|3^{n+1}n^2(x+2)^n|} = \lim_{n \rightarrow \infty} \frac{(n+1)^2}{3n^2}|(x+2)| = \frac{1}{3}|(x+2)|.$$

Hence the series converges absolutely for  $\frac{1}{3}|x+2| < 1$ , or  $|x+2| < 3$ . The radius of convergence is  $\rho = 3$ . At  $x = -5$  and  $x = +1$ , the series diverges, since the  $n$ -th term does not approach zero.

8. Applying the ratio test,

$$\lim_{n \rightarrow \infty} \frac{|n^n(n+1)!x^{n+1}|}{|(n+1)^{n+1}n!x^n|} = \lim_{n \rightarrow \infty} \frac{n^n}{(n+1)^n}|x| = \frac{1}{e}|x|,$$

since

$$\lim_{n \rightarrow \infty} \frac{n^n}{(n+1)^n} = \lim_{n \rightarrow \infty} \left(1 + \frac{1}{n}\right)^{-n} = e^{-1}.$$

Hence the series converges absolutely for  $|x| < e$ . The radius of convergence is  $\rho = e$ . At  $x = \pm e$ , the series *diverges*, since the  $n$ -th term does not approach zero. This follows from the fact that

$$\lim_{n \rightarrow \infty} \frac{n!e^n}{n^n\sqrt{2\pi n}} = 1.$$

10. We have  $f(x) = e^x$ , with  $f^{(n)}(x) = e^x$ , for  $n = 1, 2, \dots$ . Therefore  $f^{(n)}(0) = 1$ . Hence the Taylor expansion about  $x_0 = 0$  is

$$e^x = \sum_{n=0}^{\infty} \frac{x^n}{n!}.$$

Applying the ratio test,

$$\lim_{n \rightarrow \infty} \frac{|n!x^{n+1}|}{|(n+1)!x^n|} = \lim_{n \rightarrow \infty} \frac{1}{n+1}|x| = 0.$$

The radius of convergence is  $\rho = \infty$ .

11. We have  $f(x) = x$ , with  $f'(x) = 1$  and  $f^{(n)}(x) = 0$ , for  $n = 2, \dots$ . Clearly,  $f(1) = 1$  and  $f'(1) = 1$ , with all other derivatives equal to *zero*. Hence the Taylor expansion about  $x_0 = 1$  is

$$x = 1 + (x - 1).$$

Since the series has only a finite number of terms, the converges absolutely for all  $x$ .

14. We have  $f(x) = 1/(1+x)$ ,  $f'(x) = -1/(1+x)^2$ ,  $f''(x) = 2/(1+x)^3, \dots$  with  $f^{(n)}(x) = (-1)^n n!/(1+x)^{n+1}$ , for  $n \geq 1$ . It follows that  $f^{(n)}(0) = (-1)^n n!$



for  $n \geq 0$ . Hence the Taylor expansion about  $x_0 = 0$  is

$$\frac{1}{1+x} = \sum_{n=0}^{\infty} (-1)^n x^n.$$

Applying the ratio test,

$$\lim_{n \rightarrow \infty} \frac{|x^{n+1}|}{|x^n|} = \lim_{n \rightarrow \infty} |x| = |x|.$$

The series converges absolutely for  $|x| < 1$ , but diverges at  $x = \pm 1$ .

15. We have  $f(x) = 1/(1-x)$ ,  $f'(x) = 1/(1-x)^2$ ,  $f''(x) = 2/(1-x)^3$ ,  $\dots$  with  $f^{(n)}(x) = n!/(1-x)^{n+1}$ , for  $n \geq 1$ . It follows that  $f^{(n)}(0) = n!$ , for  $n \geq 0$ . Hence the Taylor expansion about  $x_0 = 0$  is

$$\frac{1}{1-x} = \sum_{n=0}^{\infty} x^n.$$

Applying the ratio test,

$$\lim_{n \rightarrow \infty} \frac{|x^{n+1}|}{|x^n|} = \lim_{n \rightarrow \infty} |x| = |x|.$$

The series converges absolutely for  $|x| < 1$ , but diverges at  $x = \pm 1$ .

16. We have  $f(x) = 1/(1-x)$ ,  $f'(x) = 1/(1-x)^2$ ,  $f''(x) = 2/(1-x)^3$ ,  $\dots$  with  $f^{(n)}(x) = n!/(1-x)^{n+1}$ , for  $n \geq 1$ . It follows that  $f^{(n)}(2) = (-1)^{n+1}n!$  for  $n \geq 0$ . Hence the Taylor expansion about  $x_0 = 2$  is

$$\frac{1}{1-x} = - \sum_{n=0}^{\infty} (-1)^n (x-2)^n.$$

Applying the ratio test,

$$\lim_{n \rightarrow \infty} \frac{|(x-2)^{n+1}|}{|(x-2)^n|} = \lim_{n \rightarrow \infty} |x-2| = |x-2|.$$

The series converges absolutely for  $|x-2| < 1$ , but diverges at  $x = 1$  and  $x = 3$ .

17. Applying the ratio test,

$$\lim_{n \rightarrow \infty} \frac{|(n+1)x^{n+1}|}{|n x^n|} = \lim_{n \rightarrow \infty} \frac{n+1}{n} |x| = |x|.$$

The series converges absolutely for  $|x| < 1$ . Term-by-term differentiation results in

$$y' = \sum_{n=1}^{\infty} n^2 x^{n-1} = 1 + 4x + 9x^2 + 16x^3 + \dots$$

$$y'' = \sum_{n=2}^{\infty} n^2(n-1)x^{n-2} = 4 + 18x + 48x^2 + 100x^3 + \dots$$

Shifting the indices, we can also write

$$y' = \sum_{n=0}^{\infty} (n+1)^2 x^n \quad \text{and} \quad y'' = \sum_{n=0}^{\infty} (n+2)^2(n+1)x^n.$$

20. Shifting the index in the *second* series, that is, setting  $n = k + 1$ ,

$$\sum_{k=0}^{\infty} a_k x^{k+1} = \sum_{n=1}^{\infty} a_{n-1} x^n.$$

Hence

$$\begin{aligned} \sum_{k=0}^{\infty} a_{k+1} x^k + \sum_{k=0}^{\infty} a_k x^{k+1} &= \sum_{k=0}^{\infty} a_{k+1} x^k + \sum_{k=1}^{\infty} a_{k-1} x^k \\ &= a_1 + \sum_{k=1}^{\infty} (a_{k+1} + a_{k-1}) x^{k+1}. \end{aligned}$$

21. Shifting the index by 2, that is, setting  $m = n - 2$ ,

$$\begin{aligned} \sum_{n=2}^{\infty} n(n-1)a_n x^{n-2} &= \sum_{m=0}^{\infty} (m+2)(m+1)a_{m+2} x^m \\ &= \sum_{n=0}^{\infty} (n+2)(n+1)a_{n+2} x^n. \end{aligned}$$

22. Shift the index *down* by 2, that is, set  $m = n + 2$ . It follows that

$$\begin{aligned} \sum_{n=0}^{\infty} a_n x^{n+2} &= \sum_{m=2}^{\infty} a_{m-2} x^m \\ &= \sum_{n=2}^{\infty} a_{n-2} x^n. \end{aligned}$$

24. Clearly,

$$(1 - x^2) \sum_{n=2}^{\infty} n(n-1)a_n x^{n-2} = \sum_{n=2}^{\infty} n(n-1)a_n x^{n-2} - \sum_{n=2}^{\infty} n(n-1)a_n x^n.$$

Shifting the index in the *first* series, that is, setting  $k = n - 2$ ,

$$\begin{aligned} \sum_{n=2}^{\infty} n(n-1)a_n x^{n-2} &= \sum_{k=0}^{\infty} (k+2)(k+1)a_{k+2} x^k \\ &= \sum_{n=0}^{\infty} (n+2)(n+1)a_{n+2} x^n. \end{aligned}$$

Hence

$$(1 - x^2) \sum_{n=2}^{\infty} n(n-1)a_n x^{n-2} = \sum_{n=0}^{\infty} (n+2)(n+1)a_{n+2} x^n - \sum_{n=2}^{\infty} n(n-1)a_n x^n.$$

Note that when  $n = 0$  and  $n = 1$ , the coefficients in the *second* series are *zero*. So that

$$(1 - x^2) \sum_{n=2}^{\infty} n(n-1)a_n x^{n-2} = \sum_{n=0}^{\infty} [(n+2)(n+1)a_{n+2} - n(n-1)a_n] x^n.$$

26. Clearly,

$$\sum_{n=1}^{\infty} n a_n x^{n-1} + x \sum_{n=0}^{\infty} a_n x^n = \sum_{n=1}^{\infty} n a_n x^{n-1} + \sum_{n=0}^{\infty} a_n x^{n+1}.$$

Shifting the index in the *first* series, that is, setting  $k = n - 1$ ,

$$\sum_{n=1}^{\infty} n a_n x^{n-1} = \sum_{k=0}^{\infty} (k+1) a_{k+1} x^k.$$

Shifting the index in the *second* series, that is, setting  $k = n + 1$ ,

$$\sum_{n=0}^{\infty} a_n x^{n+1} = \sum_{k=1}^{\infty} a_{k-1} x^k.$$

Combining the series, and starting the summation at  $n = 1$ ,

$$\sum_{n=1}^{\infty} n a_n x^{n-1} + x \sum_{n=0}^{\infty} a_n x^n = a_1 + \sum_{n=1}^{\infty} [(n+1)a_{n+1} + a_{n-1}] x^n.$$

27. We note that

$$x \sum_{n=2}^{\infty} n(n-1)a_n x^{n-2} + \sum_{n=0}^{\infty} a_n x^n = \sum_{n=2}^{\infty} n(n-1)a_n x^{n-1} + \sum_{n=0}^{\infty} a_n x^n.$$

Shifting the index in the *first* series, that is, setting  $k = n - 1$ ,

$$\begin{aligned} \sum_{n=2}^{\infty} n(n-1)a_n x^{n-1} &= \sum_{k=1}^{\infty} k(k+1)a_{k+1}x^k \\ &= \sum_{k=0}^{\infty} k(k+1)a_{k+1}x^k, \end{aligned}$$

since the coefficient of the term associated with  $k = 0$  is *zero*. Combining the series,

$$x \sum_{n=2}^{\infty} n(n-1)a_n x^{n-2} + \sum_{n=0}^{\infty} a_n x^n = \sum_{n=0}^{\infty} [n(n+1)a_{n+1} + a_n]x^n.$$

## Section 5.2

1. Let  $y = a_0 + a_1x + a_2x^2 + \cdots + a_nx^n + \cdots$ . Then

$$y'' = \sum_{n=2}^{\infty} n(n-1)a_nx^{n-2} = \sum_{n=0}^{\infty} (n+2)(n+1)a_{n+2}x^n.$$

Substitution into the ODE results in

$$\sum_{n=0}^{\infty} (n+2)(n+1)a_{n+2}x^n - \sum_{n=0}^{\infty} a_nx^n = 0$$

or

$$\sum_{n=0}^{\infty} [(n+2)(n+1)a_{n+2} - a_n]x^n = 0.$$

Equating all the coefficients to zero,

$$(n+2)(n+1)a_{n+2} - a_n = 0, \quad n = 0, 1, 2, \dots$$

We obtain the recurrence relation

$$a_{n+2} = \frac{a_n}{(n+1)(n+2)}, \quad n = 0, 1, 2, \dots$$

The subscripts differ by two, so for  $k = 1, 2, \dots$

$$a_{2k} = \frac{a_{2k-2}}{(2k-1)2k} = \frac{a_{2k-4}}{(2k-3)(2k-2)(2k-1)2k} = \cdots = \frac{a_0}{(2k)!}$$

and

$$a_{2k+1} = \frac{a_{2k-1}}{2k(2k+1)} = \frac{a_{2k-3}}{(2k-2)(2k-1)2k(2k+1)} = \cdots = \frac{a_1}{(2k+1)!}.$$

Hence

$$y = a_0 \sum_{k=0}^{\infty} \frac{x^{2k}}{(2k)!} + a_1 \sum_{k=0}^{\infty} \frac{x^{2k+1}}{(2k+1)!}.$$

The linearly independent solutions are

$$y_1 = a_0 \left( 1 + \frac{x^2}{2!} + \frac{x^4}{4!} + \frac{x^6}{6!} + \cdots \right) = a_0 \cosh x$$

$$y_2 = a_1 \left( x + \frac{x^3}{3!} + \frac{x^5}{5!} + \frac{x^7}{7!} + \cdots \right) = a_1 \sinh x.$$

4. Let  $y = a_0 + a_1x + a_2x^2 + \cdots + a_nx^n + \cdots$ . Then

$$y'' = \sum_{n=2}^{\infty} n(n-1)a_nx^{n-2} = \sum_{n=0}^{\infty} (n+2)(n+1)a_{n+2}x^n.$$

Substitution into the ODE results in

$$\sum_{n=0}^{\infty} (n+2)(n+1)a_{n+2}x^n + k^2x^2 \sum_{n=0}^{\infty} a_nx^n = 0.$$

Rewriting the *second* summation,

$$\sum_{n=0}^{\infty} (n+2)(n+1)a_{n+2}x^n + \sum_{n=2}^{\infty} k^2a_{n-2}x^n = 0,$$

that is,

$$2a_2 + 3 \cdot 2a_3x + \sum_{n=2}^{\infty} [(n+2)(n+1)a_{n+2} + k^2a_{n-2}]x^n = 0.$$

Setting the coefficients equal to *zero*, we have  $a_2 = 0$ ,  $a_3 = 0$ , and

$$(n+2)(n+1)a_{n+2} + k^2a_{n-2} = 0, \quad \text{for } n = 2, 3, 4, \dots$$

The recurrence relation can be written as

$$a_{n+2} = -\frac{k^2a_{n-2}}{(n+2)(n+1)}, \quad n = 2, 3, 4, \dots$$

The indices differ by *four*, so  $a_4, a_8, a_{12}, \dots$  are defined by

$$a_4 = -\frac{k^2a_0}{4 \cdot 3}, \quad a_8 = -\frac{k^2a_4}{8 \cdot 7}, \quad a_{12} = -\frac{k^2a_8}{12 \cdot 11}, \dots$$

Similarly,  $a_5, a_9, a_{13}, \dots$  are defined by

$$a_5 = -\frac{k^2a_1}{5 \cdot 4}, \quad a_9 = -\frac{k^2a_5}{9 \cdot 8}, \quad a_{13} = -\frac{k^2a_9}{13 \cdot 12}, \dots$$

The remaining coefficients are *zero*. Therefore the general solution is

$$y = a_0 \left[ 1 - \frac{k^2}{4 \cdot 3}x^4 + \frac{k^4}{8 \cdot 7 \cdot 4 \cdot 3}x^8 - \frac{k^6}{12 \cdot 11 \cdot 8 \cdot 7 \cdot 4 \cdot 3}x^{12} + \cdots \right] + a_1 \left[ x - \frac{k^2}{5 \cdot 4}x^5 + \frac{k^4}{9 \cdot 8 \cdot 5 \cdot 4}x^9 - \frac{k^6}{13 \cdot 12 \cdot 9 \cdot 8 \cdot 4 \cdot 4}x^{13} + \cdots \right].$$

Note that for the *even* coefficients,

$$a_{4m} = -\frac{k^2 a_{4m-4}}{(4m-1)4m}, \quad m = 1, 2, 3, \dots$$

and for the *odd* coefficients,

$$a_{4m+1} = -\frac{k^2 a_{4m-3}}{4m(4m+1)}, \quad m = 1, 2, 3, \dots$$

Hence the linearly independent solutions are

$$y_1(x) = 1 + \sum_{m=0}^{\infty} \frac{(-1)^{m+1} (k^2 x^4)^{m+1}}{3 \cdot 4 \cdot 7 \cdot 8 \cdots (4m+3)(4m+4)}$$

$$y_2(x) = x \left[ 1 + \sum_{m=0}^{\infty} \frac{(-1)^{m+1} (k^2 x^4)^{m+1}}{4 \cdot 5 \cdot 8 \cdot 9 \cdots (4m+4)(4m+5)} \right].$$

6. Let  $y = a_0 + a_1x + a_2x^2 + \cdots + a_nx^n + \cdots$ . Then

$$y' = \sum_{n=1}^{\infty} n a_n x^{n-1} = \sum_{n=0}^{\infty} (n+1) a_{n+1} x^n$$

and

$$y'' = \sum_{n=2}^{\infty} n(n-1) a_n x^{n-2} = \sum_{n=0}^{\infty} (n+2)(n+1) a_{n+2} x^n.$$

Substitution into the ODE results in

$$(2+x^2) \sum_{n=0}^{\infty} (n+2)(n+1) a_{n+2} x^n - x \sum_{n=0}^{\infty} (n+1) a_{n+1} x^n + 4 \sum_{n=0}^{\infty} a_n x^n = 0.$$

Before proceeding, write

$$x^2 \sum_{n=0}^{\infty} (n+2)(n+1) a_{n+2} x^n = \sum_{n=2}^{\infty} n(n-1) a_n x^n$$

and

$$x \sum_{n=0}^{\infty} (n+1) a_{n+1} x^n = \sum_{n=1}^{\infty} n a_n x^n.$$

It follows that

$$4a_0 + 4a_2 + (3a_1 + 12a_3)x + \sum_{n=2}^{\infty} [2(n+2)(n+1)a_{n+2} + n(n-1)a_n - n a_n + 4a_n] x^n = 0.$$

Equating the coefficients to *zero*, we find that  $a_2 = -a_0$ ,  $a_3 = -a_1/4$ , and

$$a_{n+2} = -\frac{n^2 - 2n + 4}{2(n+2)(n+1)} a_n, \quad n = 0, 1, 2, \dots.$$

The indices differ by *two*, so for  $k = 0, 1, 2, \dots$

$$a_{2k+2} = -\frac{(2k)^2 - 4k + 4}{2(2k+2)(2k+1)} a_{2k}$$

and

$$a_{2k+3} = -\frac{(2k+1)^2 - 4k + 2}{2(2k+3)(2k+2)} a_{2k+1}.$$

Hence the linearly independent solutions are

$$y_1(x) = 1 - x^2 + \frac{x^4}{6} - \frac{x^6}{30} + \dots$$

$$y_2(x) = x - \frac{x^3}{4} + \frac{7x^5}{160} - \frac{19x^7}{1920} + \dots.$$

7. Let  $y = a_0 + a_1x + a_2x^2 + \dots + a_nx^n + \dots$ . Then

$$y' = \sum_{n=1}^{\infty} n a_n x^{n-1} = \sum_{n=0}^{\infty} (n+1) a_{n+1} x^n$$

and

$$y'' = \sum_{n=2}^{\infty} n(n-1) a_n x^{n-2} = \sum_{n=0}^{\infty} (n+2)(n+1) a_{n+2} x^n.$$

Substitution into the ODE results in

$$\sum_{n=0}^{\infty} (n+2)(n+1) a_{n+2} x^n + x \sum_{n=0}^{\infty} (n+1) a_{n+1} x^n + 2 \sum_{n=0}^{\infty} a_n x^n = 0.$$

First write

$$x \sum_{n=0}^{\infty} (n+1) a_{n+1} x^n = \sum_{n=1}^{\infty} n a_n x^n.$$

We then obtain

$$2a_2 + 2a_0 + \sum_{n=1}^{\infty} [(n+2)(n+1) a_{n+2} + n a_n + 2a_n] x^n = 0.$$



It follows that  $a_2 = -a_0$  and  $a_{n+2} = -a_n/(n+1)$ ,  $n = 0, 1, 2, \dots$ . Note that the indices differ by *two*, so for  $k = 1, 2, \dots$

$$a_{2k} = -\frac{a_{2k-2}}{2k-1} = \frac{a_{2k-4}}{(2k-3)(2k-1)} = \dots = \frac{(-1)^k a_0}{1 \cdot 3 \cdot 5 \cdots (2k-1)}$$

and

$$a_{2k+1} = -\frac{a_{2k-1}}{2k} = \frac{a_{2k-3}}{(2k-2)2k} = \dots = \frac{(-1)^k a_1}{2 \cdot 4 \cdot 6 \cdots (2k)}.$$

Hence the linearly independent solutions are

$$y_1(x) = 1 - \frac{x^2}{1} + \frac{x^4}{1 \cdot 3} - \frac{x^6}{1 \cdot 3 \cdot 5} + \dots = 1 + \sum_{n=1}^{\infty} \frac{(-1)^n x^{2n}}{1 \cdot 3 \cdot 5 \cdots (2n-1)}$$

$$y_2(x) = x - \frac{x^3}{2} + \frac{x^5}{2 \cdot 4} - \frac{x^7}{2 \cdot 4 \cdot 6} + \dots = x + \sum_{n=1}^{\infty} \frac{(-1)^n x^{2n+1}}{2 \cdot 4 \cdot 6 \cdots (2n)}.$$

9. Let  $y = a_0 + a_1x + a_2x^2 + \dots + a_nx^n + \dots$ . Then

$$y' = \sum_{n=1}^{\infty} n a_n x^{n-1} = \sum_{n=0}^{\infty} (n+1) a_{n+1} x^n$$

and

$$y'' = \sum_{n=2}^{\infty} n(n-1) a_n x^{n-2} = \sum_{n=0}^{\infty} (n+2)(n+1) a_{n+2} x^n.$$

Substitution into the ODE results in

$$(1+x^2) \sum_{n=0}^{\infty} (n+2)(n+1) a_{n+2} x^n - 4x \sum_{n=0}^{\infty} (n+1) a_{n+1} x^n + 6 \sum_{n=0}^{\infty} a_n x^n = 0.$$

Before proceeding, write

$$x^2 \sum_{n=0}^{\infty} (n+2)(n+1) a_{n+2} x^n = \sum_{n=2}^{\infty} n(n-1) a_n x^n$$

and

$$x \sum_{n=0}^{\infty} (n+1) a_{n+1} x^n = \sum_{n=1}^{\infty} n a_n x^n.$$

It follows that

$$6a_0 + 2a_2 + (2a_1 + 6a_3)x + \sum_{n=2}^{\infty} [(n+2)(n+1)a_{n+2} + n(n-1)a_n - 4na_n + 6a_n]x^n = 0.$$

Setting the coefficients equal to *zero*, we obtain  $a_2 = -3a_0$ ,  $a_3 = -a_1/3$ , and

$$a_{n+2} = -\frac{(n-2)(n-3)}{(n+1)(n+2)} a_n, \quad n = 0, 1, 2, \dots$$

Observe that for  $n = 2$  and  $n = 3$ , we obtain  $a_4 = a_5 = 0$ . Since the indices differ by *two*, we also have  $a_n = 0$  for  $n \geq 4$ . Therefore the general solution is a polynomial

$$y = a_0 + a_1x - 3a_0x^2 - a_1x^3/3.$$

Hence the linearly independent solutions are

$$y_1(x) = 1 - 3x^2 \quad \text{and} \quad y_2(x) = x - x^3/3.$$

10. Let  $y = a_0 + a_1x + a_2x^2 + \dots + a_nx^n + \dots$ . Then

$$y'' = \sum_{n=2}^{\infty} n(n-1)a_nx^{n-2} = \sum_{n=0}^{\infty} (n+2)(n+1)a_{n+2}x^n.$$

Substitution into the ODE results in

$$(4 - x^2) \sum_{n=0}^{\infty} (n+2)(n+1)a_{n+2}x^n + 2 \sum_{n=0}^{\infty} a_nx^n = 0.$$

First write

$$x^2 \sum_{n=0}^{\infty} (n+2)(n+1)a_{n+2}x^n = \sum_{n=2}^{\infty} n(n-1)a_nx^n.$$

It follows that

$$2a_0 + 8a_2 + (2a_1 + 24a_3)x + \sum_{n=2}^{\infty} [4(n+2)(n+1)a_{n+2} - n(n-1)a_n + 2a_n]x^n = 0.$$

We obtain  $a_2 = -a_0/4$ ,  $a_3 = -a_1/12$  and

$$4(n+2)a_{n+2} = (n-2)a_n, \quad n = 0, 1, 2, \dots$$

Note that for  $n = 2$ ,  $a_4 = 0$ . Since the indices differ by *two*, we also have  $a_{2k} = 0$  for  $k = 2, 3, \dots$ . On the other hand, for  $k = 1, 2, \dots$ ,

$$a_{2k+1} = \frac{(2k-3)a_{2k-1}}{4(2k+1)} = \frac{(2k-5)(2k-3)a_{2k-3}}{4^2(2k-1)(2k+1)} = \dots = \frac{-a_1}{4^k(2k-1)(2k+1)}.$$

Therefore the general solution is

$$y = a_0 + a_1x - a_0 \frac{x^2}{4} - a_1 \sum_{n=1}^{\infty} \frac{x^{2n+1}}{4^n(2n-1)(2n+1)}.$$

Hence the linearly independent solutions are  $y_1(x) = 1 - x^2/4$  and

$$y_2(x) = x - \frac{x^3}{12} - \frac{x^5}{240} - \frac{x^7}{2240} - \cdots = x - \sum_{n=1}^{\infty} \frac{x^{2n+1}}{4^n(2n-1)(2n+1)}.$$

11. Let  $y = a_0 + a_1x + a_2x^2 + \cdots + a_nx^n + \cdots$ . Then

$$y' = \sum_{n=1}^{\infty} na_nx^{n-1} = \sum_{n=0}^{\infty} (n+1)a_{n+1}x^n$$

and

$$y'' = \sum_{n=2}^{\infty} n(n-1)a_nx^{n-2} = \sum_{n=0}^{\infty} (n+2)(n+1)a_{n+2}x^n.$$

Substitution into the ODE results in

$$(3-x^2) \sum_{n=0}^{\infty} (n+2)(n+1)a_{n+2}x^n - 3x \sum_{n=0}^{\infty} (n+1)a_{n+1}x^n - \sum_{n=0}^{\infty} a_nx^n = 0.$$

Before proceeding, write

$$x^2 \sum_{n=0}^{\infty} (n+2)(n+1)a_{n+2}x^n = \sum_{n=2}^{\infty} n(n-1)a_nx^n$$

and

$$x \sum_{n=0}^{\infty} (n+1)a_{n+1}x^n = \sum_{n=1}^{\infty} na_nx^n.$$

It follows that

$$6a_2 - a_0 + (-4a_1 + 18a_3)x + \sum_{n=2}^{\infty} [3(n+2)(n+1)a_{n+2} - n(n-1)a_n - 3na_n - a_n]x^n = 0.$$

We obtain  $a_2 = a_0/6$ ,  $2a_3 = a_1/9$ , and

$$3(n+2)a_{n+2} = (n+1)a_n, \quad n = 0, 1, 2, \dots$$

The indices differ by *two*, so for  $k = 1, 2, \dots$

$$a_{2k} = \frac{(2k-1)a_{2k-2}}{3(2k)} = \frac{(2k-3)(2k-1)a_{2k-4}}{3^2(2k-2)(2k)} = \cdots = \frac{3 \cdot 5 \cdots (2k-1) a_0}{3^k \cdot 2 \cdot 4 \cdots (2k)}$$

and

$$a_{2k+1} = \frac{(2k)a_{2k-1}}{3(2k+1)} = \frac{(2k-2)(2k)a_{2k-3}}{3^2(2k-1)(2k+1)} = \cdots = \frac{2 \cdot 4 \cdot 6 \cdots (2k) a_1}{3^k \cdot 3 \cdot 5 \cdots (2k+1)}.$$

Hence the linearly independent solutions are

$$y_1(x) = 1 + \frac{x^2}{6} + \frac{x^4}{24} + \frac{5x^6}{432} + \cdots = 1 + \sum_{n=1}^{\infty} \frac{3 \cdot 5 \cdots (2n-1) x^{2n}}{3^n \cdot 2 \cdot 4 \cdots (2n)}$$

$$y_2(x) = x + \frac{2x^3}{9} + \frac{8x^5}{135} + \frac{16x^7}{945} + \cdots = x + \sum_{n=1}^{\infty} \frac{2 \cdot 4 \cdot 6 \cdots (2n) x^{2n+1}}{3^n \cdot 3 \cdot 5 \cdots (2n+1)}.$$

12. Let  $y = a_0 + a_1x + a_2x^2 + \cdots + a_nx^n + \cdots$ . Then

$$y' = \sum_{n=1}^{\infty} n a_n x^{n-1} = \sum_{n=0}^{\infty} (n+1) a_{n+1} x^n$$

and

$$y'' = \sum_{n=2}^{\infty} n(n-1) a_n x^{n-2} = \sum_{n=0}^{\infty} (n+2)(n+1) a_{n+2} x^n.$$

Substitution into the ODE results in

$$(1-x) \sum_{n=0}^{\infty} (n+2)(n+1) a_{n+2} x^n + x \sum_{n=0}^{\infty} (n+1) a_{n+1} x^n - \sum_{n=0}^{\infty} a_n x^n = 0.$$

Before proceeding, write

$$x \sum_{n=0}^{\infty} (n+2)(n+1) a_{n+2} x^n = \sum_{n=1}^{\infty} (n+1)n a_{n+1} x^n$$

and

$$x \sum_{n=0}^{\infty} (n+1) a_{n+1} x^n = \sum_{n=1}^{\infty} n a_n x^n.$$

It follows that

$$2a_2 - a_0 + \sum_{n=1}^{\infty} [(n+2)(n+1)a_{n+2} - (n+1)n a_{n+1} + n a_n - a_n] x^n = 0.$$

We obtain  $a_2 = a_0/2$  and

$$(n+2)(n+1)a_{n+2} - (n+1)n a_{n+1} + (n-1)a_n = 0$$

for  $n = 0, 1, 2, \dots$ . Writing out the individual equations,

$$\begin{aligned}
3 \cdot 2 a_3 - 2 \cdot 1 a_2 &= 0 \\
4 \cdot 3 a_4 - 3 \cdot 2 a_3 + a_2 &= 0 \\
5 \cdot 4 a_5 - 4 \cdot 3 a_4 + 2 a_3 &= 0 \\
6 \cdot 5 a_6 - 5 \cdot 4 a_5 + 3 a_4 &= 0 \\
&\vdots
\end{aligned}$$

The coefficients can be calculated successively as  $a_3 = a_0/(2 \cdot 3)$ ,  $a_4 = a_3/2 - a_2/12 = a_0/24$ ,  $a_5 = 3a_4/5 - a_3/10 = a_0/120$ ,  $\dots$ . We can now see that for  $n \geq 2$ ,  $a_n$  is proportional to  $a_0$ . In fact, for  $n \geq 2$ ,  $a_n = a_0/(n!)$ . Therefore the general solution is

$$y = a_0 + a_1 x + \frac{a_0 x^2}{2!} + \frac{a_0 x^3}{3!} + \frac{a_0 x^4}{4!} + \dots$$

Hence the linearly independent solutions are  $y_2(x) = x$  and

$$y_1(x) = 1 + \sum_{n=2}^{\infty} \frac{x^n}{n!}.$$

13. Let  $y = a_0 + a_1 x + a_2 x^2 + \dots + a_n x^n + \dots$ . Then

$$y' = \sum_{n=1}^{\infty} n a_n x^{n-1} = \sum_{n=0}^{\infty} (n+1) a_{n+1} x^n$$

and

$$y'' = \sum_{n=2}^{\infty} n(n-1) a_n x^{n-2} = \sum_{n=0}^{\infty} (n+2)(n+1) a_{n+2} x^n.$$

Substitution into the ODE results in

$$2 \sum_{n=0}^{\infty} (n+2)(n+1) a_{n+2} x^n + x \sum_{n=0}^{\infty} (n+1) a_{n+1} x^n + 3 \sum_{n=0}^{\infty} a_n x^n = 0.$$

First write

$$x \sum_{n=0}^{\infty} (n+1) a_{n+1} x^n = \sum_{n=1}^{\infty} n a_n x^n.$$

We then obtain

$$4a_2 + 3a_0 + \sum_{n=1}^{\infty} [2(n+2)(n+1)a_{n+2} + n a_n + 3a_n] x^n = 0.$$

It follows that  $a_2 = -3a_0/4$  and

$$2(n+2)(n+1)a_{n+2} + (n+3)a_n = 0$$

for  $n = 0, 1, 2, \dots$ . The indices differ by *two*, so for  $k = 1, 2, \dots$

$$\begin{aligned} a_{2k} &= -\frac{(2k+1)a_{2k-2}}{2(2k-1)(2k)} = \frac{(2k-1)(2k+1)a_{2k-4}}{2^2(2k-3)(2k-2)(2k-1)(2k)} = \dots \\ &= \frac{(-1)^k 3 \cdot 5 \cdots (2k+1)}{2^k (2k)!} a_0. \end{aligned}$$

and

$$\begin{aligned} a_{2k+1} &= -\frac{(2k+2)a_{2k-1}}{2(2k)(2k+1)} = \frac{(2k)(2k+2)a_{2k-3}}{2^2(2k-2)(2k-1)(2k)(2k+1)} = \dots \\ &= \frac{(-1)^k 4 \cdot 6 \cdots (2k)(2k+2)}{2^k (2k+1)!} a_1. \end{aligned}$$

Hence the linearly independent solutions are

$$y_1(x) = 1 - \frac{3}{4}x^2 + \frac{5}{32}x^4 - \frac{7}{384}x^6 + \dots = \sum_{n=0}^{\infty} \frac{(-1)^n 3 \cdot 5 \cdots (2n+1)}{2^n (2n)!} x^{2n}$$

$$y_2(x) = x - \frac{1}{3}x^3 + \frac{1}{20}x^5 - \frac{1}{210}x^7 + \dots = x + \sum_{n=1}^{\infty} \frac{(-1)^n 4 \cdot 6 \cdots (2n+2)}{2^n (2n+1)!} x^{2n+1}.$$

15(a). From Prob. 2, we have

$$y_1(x) = \sum_{n=0}^{\infty} \frac{x^{2n}}{2^n n!} \quad \text{and} \quad y_2(x) = \sum_{n=0}^{\infty} \frac{2^n n! x^{2n+1}}{(2n+1)!}.$$

Since  $a_0 = y(0)$  and  $a_1 = y'(0)$ , we have  $y(x) = 2y_1(x) + y_2(x)$ . That is,

$$y(x) = 2 + x + x^2 + \frac{1}{3}x^3 + \frac{1}{4}x^4 + \frac{1}{15}x^5 + \frac{1}{24}x^6 + \dots$$

The *four-* and *five-*term polynomial approximations are

$$\begin{aligned} p_4 &= 2 + x + x^2 + x^3/3 \\ p_5 &= 2 + x + x^2 + x^3/3 + x^4/4. \end{aligned}$$

(b).

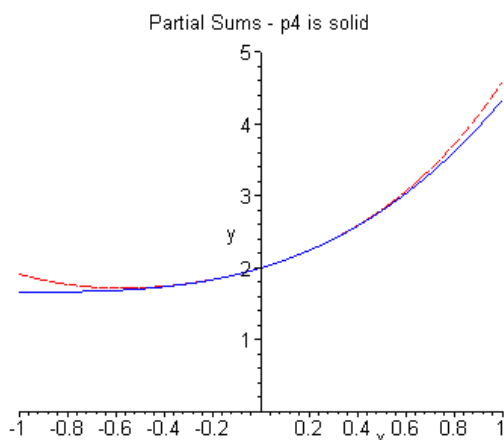

(c). The *four-term* approximation  $p_4$  appears to be reasonably accurate (within 10%) on the interval  $|x| < 0.7$ .

17(a). From Prob. 7, the linearly independent solutions are

$$y_1(x) = 1 + \sum_{n=1}^{\infty} \frac{(-1)^n x^{2n}}{1 \cdot 3 \cdot 5 \cdots (2n-1)}$$

$$y_2(x) = x + \sum_{n=1}^{\infty} \frac{(-1)^n x^{2n+1}}{2 \cdot 4 \cdot 6 \cdots (2n)}.$$

Since  $a_0 = y(0)$  and  $a_1 = y'(0)$ , we have  $y(x) = 4y_1(x) - y_2(x)$ . That is,

$$y(x) = 4 - x - 4x^2 + \frac{1}{2}x^3 + \frac{4}{3}x^4 - \frac{1}{8}x^5 - \frac{4}{15}x^6 + \cdots.$$

The *four-* and *five-term* polynomial approximations are

$$p_4 = 4 - x - 4x^2 + \frac{1}{2}x^3$$

$$p_5 = 4 - x - 4x^2 + \frac{1}{2}x^3 + \frac{4}{3}x^4.$$

(b).

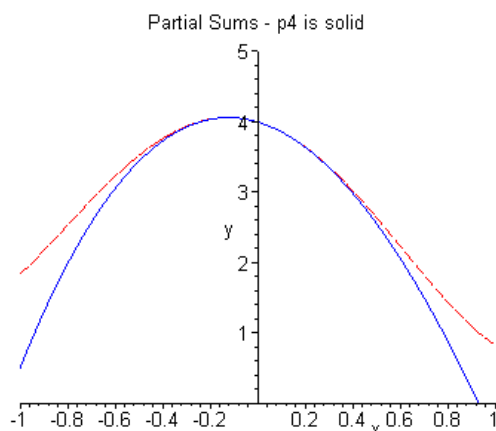

(c). The *four-term* approximation  $p_4$  appears to be reasonably accurate (within 10%) on the interval  $|x| < 0.5$ .

18(a). From Prob. 12, we have

$$y_1(x) = 1 + \sum_{n=2}^{\infty} \frac{x^n}{n!} \quad \text{and} \quad y_2(x) = x.$$

Since  $a_0 = y(0)$  and  $a_1 = y'(0)$ , we have  $y(x) = -3y_1(x) + 2y_2(x)$ . That is,

$$y(x) = -3 + 2x - \frac{3}{2}x^2 - \frac{1}{2}x^3 - \frac{1}{8}x^4 - \frac{1}{40}x^5 - \frac{1}{240}x^6 + \dots$$

The *four-* and *five-term* polynomial approximations are

$$p_4 = -3 + 2x - \frac{3}{2}x^2 - \frac{1}{2}x^3$$

$$p_5 = -3 + 2x - \frac{3}{2}x^2 - \frac{1}{2}x^3 - \frac{1}{8}x^4.$$



(b).

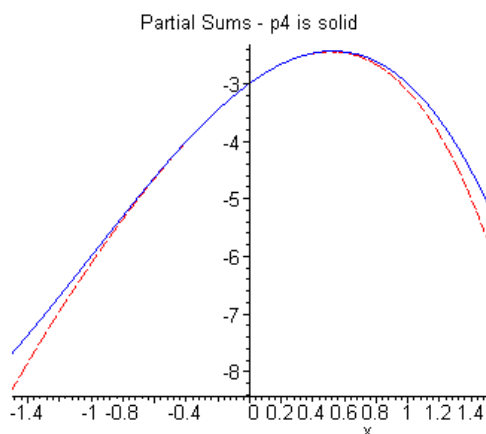

(c). The *four-term* approximation  $p_4$  appears to be reasonably accurate (within 10%) on the interval  $|x| < 0.9$ .

20. Two linearly independent solutions of *Airy's equation* (about  $x_0 = 0$ ) are

$$y_1(x) = 1 + \sum_{n=1}^{\infty} \frac{x^{3n}}{2 \cdot 3 \cdots (3n-1)(3n)}$$

$$y_2(x) = x + \sum_{n=1}^{\infty} \frac{x^{3n+1}}{3 \cdot 4 \cdots (3n)(3n+1)}.$$

Applying the *ratio test* to the terms of  $y_1(x)$ ,

$$\lim_{n \rightarrow \infty} \frac{|2 \cdot 3 \cdots (3n-1)(3n) x^{3n+3}|}{|2 \cdot 3 \cdots (3n+2)(3n+3) x^{3n}|} = \lim_{n \rightarrow \infty} \frac{1}{(3n+1)(3n+2)(3n+3)} |x|^3 = 0.$$

Similarly, applying the *ratio test* to the terms of  $y_2(x)$ ,

$$\lim_{n \rightarrow \infty} \frac{|3 \cdot 4 \cdots (3n)(3n+1) x^{3n+4}|}{|3 \cdot 4 \cdots (3n+3)(3n+4) x^{3n+1}|} = \lim_{n \rightarrow \infty} \frac{1}{(3n+2)(3n+3)(3n+4)} |x|^3 = 0.$$

Hence both series converge *absolutely* for all  $x$ .

21. Let  $y = a_0 + a_1x + a_2x^2 + \cdots + a_nx^n + \cdots$ . Then

$$y' = \sum_{n=1}^{\infty} na_nx^{n-1} = \sum_{n=0}^{\infty} (n+1)a_{n+1}x^n$$

and

$$y'' = \sum_{n=2}^{\infty} n(n-1)a_n x^{n-2} = \sum_{n=0}^{\infty} (n+2)(n+1)a_{n+2} x^n.$$

Substitution into the ODE results in

$$\sum_{n=0}^{\infty} (n+2)(n+1)a_{n+2} x^n - 2x \sum_{n=0}^{\infty} (n+1)a_{n+1} x^n + \lambda \sum_{n=0}^{\infty} a_n x^n = 0.$$

First write

$$x \sum_{n=0}^{\infty} (n+1)a_{n+1} x^n = \sum_{n=1}^{\infty} n a_n x^n.$$

We then obtain

$$2a_2 + \lambda a_0 + \sum_{n=1}^{\infty} [(n+2)(n+1)a_{n+2} - 2n a_n + \lambda a_n] x^n = 0.$$

Setting the coefficients equal to *zero*, it follows that

$$a_{n+2} = \frac{(2n - \lambda)}{(n+1)(n+2)} a_n$$

for  $n = 0, 1, 2, \dots$ . Note that the indices differ by *two*, so for  $k = 1, 2, \dots$

$$\begin{aligned} a_{2k} &= \frac{(4k-4-\lambda)a_{2k-2}}{(2k-1)2k} = \frac{(4k-8-\lambda)(4k-4-\lambda)a_{2k-4}}{(2k-3)(2k-2)(2k-1)2k} = \dots \\ &= (-1)^k \frac{\lambda \cdots (\lambda-4k+8)(\lambda-4k+4)}{(2k)!} a_0. \end{aligned}$$

and

$$\begin{aligned} a_{2k+1} &= \frac{(4k-2-\lambda)a_{2k-1}}{2k(2k+1)} = \frac{(4k-6-\lambda)(4k-2-\lambda)a_{2k-3}}{(2k-2)(2k-1)2k(2k+1)} = \dots \\ &= (-1)^k \frac{(\lambda-2) \cdots (\lambda-4k+6)(\lambda-4k+2)}{(2k+1)!} a_1. \end{aligned}$$

Hence the linearly independent solutions of the *Hermite equation* (about  $x_0 = 0$ ) are

$$\begin{aligned} y_1(x) &= 1 - \frac{\lambda}{2!}x^2 + \frac{\lambda(\lambda-4)}{4!}x^4 - \frac{\lambda(\lambda-4)(\lambda-8)}{6!}x^6 + \dots \\ y_2(x) &= x - \frac{\lambda-2}{3!}x^3 + \frac{(\lambda-2)(\lambda-6)}{5!}x^5 - \frac{(\lambda-2)(\lambda-6)(\lambda-10)}{7!}x^7 + \dots \end{aligned}$$

(b). Based on the recurrence relation

$$a_{n+2} = \frac{(2n - \lambda)}{(n + 1)(n + 2)} a_n,$$

the series solution will *terminate* as long as  $\lambda$  is a *nonnegative* even integer. If  $\lambda = 2m$ , then *one or the other* of the solutions in Part (b) will contain at most  $m/2 + 1$  terms. In particular, we obtain the polynomial solutions corresponding to  $\lambda = 0, 2, 4, 6, 8, 10$  :

$\lambda = 0$	$y_1(x) = 1$
$\lambda = 2$	$y_2(x) = x$
$\lambda = 4$	$y_1(x) = 1 - 2x^2$
$\lambda = 6$	$y_2(x) = x - 2x^3/3$
$\lambda = 8$	$y_1(x) = 1 - 4x^2 + 4x^4/3$
$\lambda = 10$	$y_2(x) = x - 4x^3/3 + 4x^5/15$

(c). Observe that if  $\lambda = 2n$ , and  $a_0 = a_1 = 1$ , then

$$a_{2k} = (-1)^k \frac{2n \cdots (2n - 4k + 8)(2n - 4k + 4)}{(2k)!}$$

and

$$a_{2k+1} = (-1)^k \frac{(2n - 2) \cdots (2n - 4k + 6)(2n - 4k + 2)}{(2k + 1)!}.$$

for  $k = 1, 2, \dots, [n/2]$ . It follows that the *coefficient* of  $x^n$ , in  $y_1$  and  $y_2$ , is

$$a_n = \begin{cases} (-1)^k \frac{4^k k!}{(2k)!} & \text{for } n = 2k \\ (-1)^k \frac{4^k k!}{(2k+1)!} & \text{for } n = 2k + 1 \end{cases}$$

Then by definition,

$$H_n(x) = \begin{cases} (-1)^k 2^n \frac{(2k)!}{4^k k!} y_1(x) = (-1)^k \frac{(2k)!}{k!} y_1(x) & \text{for } n = 2k \\ (-1)^k 2^n \frac{(2k+1)!}{4^k k!} y_2(x) = (-1)^k \frac{2(2k+1)!}{k!} y_2(x) & \text{for } n = 2k + 1 \end{cases}$$

Therefore the first six *Hermite polynomials* are

$$\begin{aligned} H_0(x) &= 1 \\ H_1(x) &= 2x \\ H_2(x) &= 4x^2 - 2 \\ H_3(x) &= 8x^3 - 12x \\ H_4(x) &= 16x^4 - 48x^2 + 12 \\ H_5(x) &= 32x^5 - 160x^3 + 120x \end{aligned}$$

23. The series solution is given by

$$y(x) = 1 + \frac{1}{2}x^2 + \frac{1}{2^2 2!}x^4 + \frac{1}{2^3 3!}x^6 + \frac{1}{2^4 4!}x^8 + \dots$$

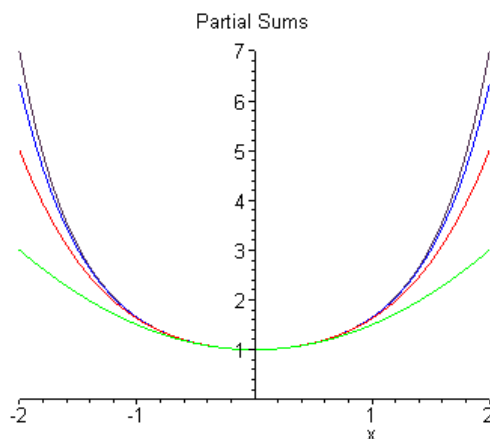

24. The series solution is given by

$$y(x) = 1 - x^2 + \frac{x^4}{6} - \frac{x^6}{30} + \frac{x^8}{120} + \dots$$

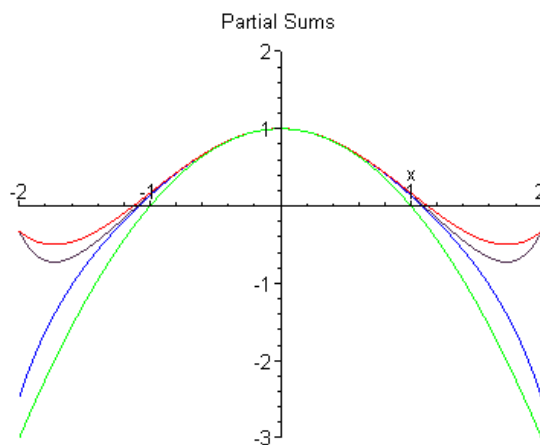

25. The series solution is given by

$$y(x) = x - \frac{x^3}{2} + \frac{x^5}{2 \cdot 4} - \frac{x^7}{2 \cdot 4 \cdot 6} + \frac{x^9}{2 \cdot 4 \cdot 6 \cdot 8} - \dots$$

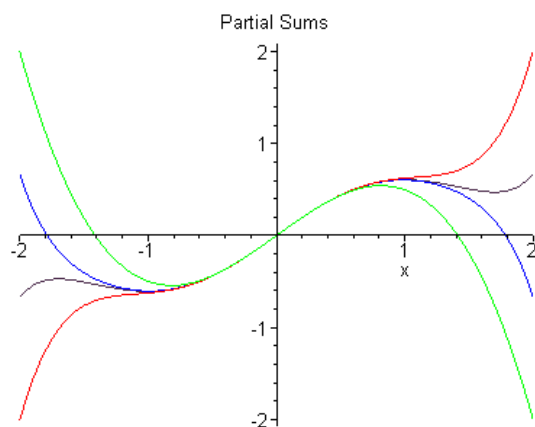

26. The series solution is given by

$$y(x) = x - \frac{x^3}{12} - \frac{x^5}{240} - \frac{x^7}{2240} - \frac{x^9}{16128} - \dots$$

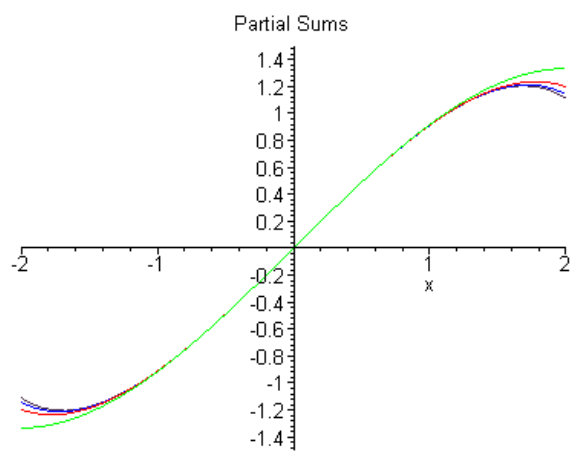

27. The series solution is given by

$$y(x) = 1 - \frac{x^4}{12} + \frac{x^8}{672} - \frac{x^{12}}{88704} + \dots$$

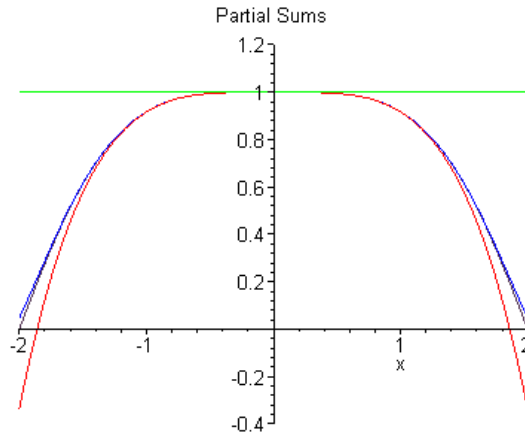

28. Let  $y = a_0 + a_1x + a_2x^2 + \dots + a_nx^n + \dots$ . Then

$$y' = \sum_{n=1}^{\infty} na_nx^{n-1} = \sum_{n=0}^{\infty} (n+1)a_{n+1}x^n$$

and

$$y'' = \sum_{n=2}^{\infty} n(n-1)a_nx^{n-2} = \sum_{n=0}^{\infty} (n+2)(n+1)a_{n+2}x^n.$$

Substitution into the ODE results in

$$(1-x) \sum_{n=0}^{\infty} (n+2)(n+1)a_{n+2}x^n + x \sum_{n=0}^{\infty} (n+1)a_{n+1}x^n - 2 \sum_{n=0}^{\infty} a_nx^n = 0.$$

After appropriately shifting the indices, it follows that

$$2a_2 - 2a_0 + \sum_{n=1}^{\infty} [(n+2)(n+1)a_{n+2} - (n+1)na_{n+1} + na_n - 2a_n]x^n = 0.$$

We find that  $a_2 = a_0$  and

$$(n+2)(n+1)a_{n+2} - (n+1)na_{n+1} + (n-2)a_n = 0$$

for  $n = 1, 2, \dots$ . Writing out the individual equations,

$$\begin{aligned} 3 \cdot 2 a_3 - 2 \cdot 1 a_2 - a_1 &= 0 \\ 4 \cdot 3 a_4 - 3 \cdot 2 a_3 &= 0 \\ 5 \cdot 4 a_5 - 4 \cdot 3 a_4 + a_3 &= 0 \\ 6 \cdot 5 a_6 - 5 \cdot 4 a_5 + 2 a_4 &= 0 \\ &\vdots \end{aligned}$$

Since  $a_0 = 0$  and  $a_1 = 1$ , the remaining coefficients satisfy the equations

$$\begin{aligned}
 3 \cdot 2 a_3 - 1 &= 0 \\
 4 \cdot 3 a_4 - 3 \cdot 2 a_3 &= 0 \\
 5 \cdot 4 a_5 - 4 \cdot 3 a_4 + a_3 &= 0 \\
 6 \cdot 5 a_6 - 5 \cdot 4 a_5 + 2 a_4 &= 0 \\
 &\vdots
 \end{aligned}$$

That is,  $a_3 = 1/6$ ,  $a_4 = 1/12$ ,  $a_5 = 1/24$ ,  $a_6 = 1/45$ ,  $\dots$ . Hence the series solution of the initial value problem is

$$y(x) = x + \frac{1}{6}x^3 + \frac{1}{12}x^4 + \frac{1}{24}x^5 + \frac{1}{45}x^6 + \frac{13}{1008}x^7 + \dots$$

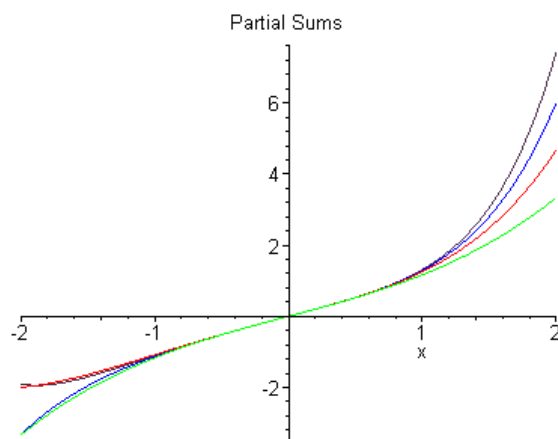

## Section 5.3

2. Let  $y = \phi(x)$  be a solution of the initial value problem. First note that

$$y'' = -(\sin x)y' - (\cos x)y.$$

Differentiating twice,

$$\begin{aligned} y''' &= -(\sin x)y'' - 2(\cos x)y' + (\sin x)y \\ y^{iv} &= -(\sin x)y''' - 3(\cos x)y'' + 3(\sin x)y' + (\cos x)y. \end{aligned}$$

Given that  $\phi(0) = 0$  and  $\phi'(0) = 1$ , the *first* equation gives  $\phi''(0) = 0$  and the last two equations give  $\phi'''(0) = -2$  and  $\phi^{iv}(0) = 0$ .

3. Let  $y = \phi(x)$  be a solution of the initial value problem. First write

$$y'' = -\frac{1+x}{x^2}y' - \frac{3\ln x}{x^2}y.$$

Differentiating twice,

$$y''' = \frac{-1}{x^3}[(x+x^2)y'' + (3x\ln x - x - 2)y' + (3 - 6\ln x)y].$$

$$\begin{aligned} y^{iv} &= \frac{-1}{x^4}[(x^2+x^3)y''' + (3x^2\ln x - 2x^2 - 4x)y'' + \\ &\quad + (6 + 8x - 12x\ln x)y' + (18\ln x - 15)y]. \end{aligned}$$

Given that  $\phi(1) = 2$  and  $\phi'(1) = 0$ , the *first* equation gives  $\phi''(1) = 0$  and the last two equations give  $\phi'''(1) = -6$  and  $\phi^{iv}(1) = 42$ .

4. Let  $y = \phi(x)$  be a solution of the initial value problem. First note that

$$y'' = -x^2y' - (\sin x)y.$$

Differentiating twice,

$$\begin{aligned} y''' &= -x^2y'' - (2x + \sin x)y' - (\cos x)y \\ y^{iv} &= -x^2y''' - (4x + \sin x)y'' - (2 + 2\cos x)y' + (\sin x)y. \end{aligned}$$

Given that  $\phi(0) = a_0$  and  $\phi'(0) = a_1$ , the *first* equation gives  $\phi''(0) = 0$  and the last two equations give  $\phi'''(0) = -a_0$  and  $\phi^{iv}(0) = -4a_1$ .

5. Clearly,  $p(x) = 4$  and  $q(x) = 6x$  are analytic for all  $x$ . Hence the series solutions converge *everywhere*.

7. The zeroes of  $P(x) = 1 + x^3$  are the *three* cube roots of  $-1$ . They all lie on the unit circle in the complex plane. So for  $x_0 = 0$ ,  $\rho_{min} = 1$ . For  $x_0 = 2$ , the *nearest*



root is  $e^{i\pi/3} = (1 + i\sqrt{3})/2$ , hence  $\rho_{min} = \sqrt{3}$ .

8. The only root of  $P(x) = x$  is *zero*. Hence  $\rho_{min} = 1$ .

9(b).  $p(x) = -x$  and  $q(x) = -1$  are analytic for all  $x$ .

(c).  $p(x) = -x$  and  $q(x) = -1$  are analytic for all  $x$ .

(d).  $p(x) = 0$  and  $q(x) = kx^2$  are analytic for all  $x$ .

(e). The only root of  $P(x) = 1 - x$  is 1. Hence  $\rho_{min} = 1$ .

(g).  $p(x) = x$  and  $q(x) = 2$  are analytic for all  $x$ .

(i). The zeroes of  $P(x) = 1 + x^2$  are  $\pm i$ . Hence  $\rho_{min} = 1$ .

(j). The zeroes of  $P(x) = 4 - x^2$  are  $\pm 2$ . Hence  $\rho_{min} = 2$ .

(k). The zeroes of  $P(x) = 3 - x^2$  are  $\pm\sqrt{3}$ . Hence  $\rho_{min} = \sqrt{3}$ .

(l). The only root of  $P(x) = 1 - x$  is 1. Hence  $\rho_{min} = 1$ .

(m).  $p(x) = x/2$  and  $q(x) = 3/2$  are analytic for all  $x$ .

(n).  $p(x) = (1 + x)/2$  and  $q(x) = 3/2$  are analytic for all  $x$ .

12. The Taylor series expansion of  $e^x$ , about  $x_0 = 0$ , is

$$e^x = \sum_{n=0}^{\infty} \frac{x^n}{n!}.$$

Let  $y = a_0 + a_1x + a_2x^2 + \cdots + a_nx^n + \cdots$ . Substituting into the ODE,

$$\left[ \sum_{n=0}^{\infty} \frac{x^n}{n!} \right] \left[ \sum_{n=0}^{\infty} (n+2)(n+1)a_{n+2}x^n \right] + x \sum_{n=0}^{\infty} a_nx^n = 0.$$

First note that

$$x \sum_{n=0}^{\infty} a_nx^n = \sum_{n=1}^{\infty} a_{n-1}x^n = a_0x + a_1x^2 + a_2x^3 + \cdots + a_{n-1}x^n + \cdots.$$

The coefficient of  $x^n$  in the *product* of the two series is

$$c_n = 2a_2 \frac{1}{n!} + 6a_3 \frac{1}{(n-1)!} + 12a_4 \frac{1}{(n-2)!} + \cdots + (n+1)a_{n+1} + (n+2)(n+1)a_{n+2}.$$

Expanding the individual series, it follows that

$$2a_2 + (2a_2 + 6a_3)x + (a_2 + 6a_3 + 12a_4)x^2 + (a_2 + 6a_3 + 12a_4 + 20a_5)x^3 + \cdots + a_0x + a_1x^2 + a_2x^3 + \cdots = 0.$$

Setting the coefficients equal to *zero*, we obtain the system  $2a_2 = 0$ ,  $2a_2 + 6a_3 + a_0 = 0$ ,  $a_2 + 6a_3 + 12a_4 + a_1 = 0$ ,  $a_2 + 6a_3 + 12a_4 + 20a_5 + a_2 = 0$ ,  $\cdots$ . Hence the general solution is

$$y(x) = a_0 + a_1x - a_0\frac{x^3}{6} + (a_0 - a_1)\frac{x^4}{12} + (2a_1 - a_0)\frac{x^5}{40} + \left(\frac{4}{3}a_0 - 2a_1\right)\frac{x^6}{120} + \dots$$

We find that two linearly independent solutions are

$$y_1(x) = 1 - \frac{x^3}{6} + \frac{x^4}{12} - \frac{x^5}{40} + \dots$$

$$y_2(x) = x - \frac{x^4}{12} + \frac{x^5}{20} - \frac{x^6}{60} + \dots$$

Since  $p(x) = 0$  and  $q(x) = xe^{-x}$  converge everywhere,  $\rho = \infty$ .

13. The Taylor series expansion of  $\cos x$ , about  $x_0 = 0$ , is

$$\cos x = \sum_{n=0}^{\infty} \frac{(-1)^n x^{2n}}{(2n)!}.$$

Let  $y = a_0 + a_1x + a_2x^2 + \dots + a_nx^n + \dots$ . Substituting into the ODE,

$$\left[ \sum_{n=0}^{\infty} \frac{(-1)^n x^{2n}}{(2n)!} \right] \left[ \sum_{n=0}^{\infty} (n+2)(n+1)a_{n+2}x^n \right] + \sum_{n=1}^{\infty} na_nx^n - 2 \sum_{n=0}^{\infty} a_nx^n = 0.$$

The coefficient of  $x^n$  in the *product* of the two series is

$$c_n = 2a_2b_n + 6a_3b_{n-1} + 12a_4b_{n-2} + \dots + (n+1)na_{n+1}b_1 + (n+2)(n+1)a_{n+2}b_0,$$

in which  $\cos x = b_0 + b_1x + b_2x^2 + \dots + b_nx^n + \dots$ . It follows that

$$2a_2 - 2a_0 + \sum_{n=1}^{\infty} c_nx^n + \sum_{n=1}^{\infty} (n-2)a_nx^n = 0.$$

Expanding the product of the series, it follows that

$$2a_2 - 2a_0 + 6a_3x + (-a_2 + 12a_4)x^2 + (-3a_3 + 20a_5)x^3 + \dots - a_1x + a_3x^3 + 2a_4x^4 + \dots = 0.$$

Setting the coefficients equal to *zero*,  $a_2 - a_0 = 0$ ,  $6a_3 - a_1 = 0$ ,  $-a_2 + 12a_4 = 0$ ,  $-3a_3 + 20a_5 + a_3 = 0$ ,  $\dots$ . Hence the general solution is

$$y(x) = a_0 + a_1x + a_0x^2 + a_1\frac{x^3}{6} + a_0\frac{x^4}{12} + a_1\frac{x^5}{60} + a_0\frac{x^6}{120} + a_1\frac{x^7}{560} + \dots$$

We find that two linearly independent solutions are

$$y_1(x) = 1 + x^2 + \frac{x^4}{12} + \frac{x^6}{120} + \dots$$

$$y_2(x) = x + \frac{x^3}{6} + \frac{x^5}{60} + \frac{x^7}{560} + \dots$$

The *nearest* zero of  $P(x) = \cos x$  is at  $x = \pm\pi/2$ . Hence  $\rho_{min} = \pi/2$ .

14. The Taylor series expansion of  $\ln(1+x)$ , about  $x_0 = 0$ , is

$$\ln(1+x) = \sum_{n=1}^{\infty} \frac{(-1)^{n+1} x^n}{n}.$$

Let  $y = a_0 + a_1x + a_2x^2 + \dots + a_nx^n + \dots$ . Substituting into the ODE,

$$\begin{aligned} & \left[ \sum_{n=0}^{\infty} \frac{(-1)^n x^n}{n!} \right] \sum_{n=0}^{\infty} (n+2)(n+1)a_{n+2}x^n + \\ & + \left[ \sum_{n=1}^{\infty} \frac{(-1)^{n+1} x^n}{n} \right] \sum_{n=0}^{\infty} (n+1)a_{n+1}x^n - x \sum_{n=0}^{\infty} a_nx^n = 0. \end{aligned}$$

The *first* product is the series

$$2a_2 + (-2a_2 + 6a_3)x + (a_2 - 6a_3 + 12a_4)x^2 + (-a_2 + 6a_3 - 12a_4 + 20a_5)x^3 + \dots.$$

The *second* product is the series

$$a_1x + (2a_2 - a_1/2)x^2 + (3a_3 - a_2 + a_1/3)x^3 + (4a_4 - 3a_3/2 + 2a_2/3 - a_1/4)x^3 + \dots.$$

Combining the series and equating the coefficients to *zero*, we obtain

$$\begin{aligned} 2a_2 &= 0 \\ -2a_2 + 6a_3 + a_1 - a_0 &= 0 \\ 12a_4 - 6a_3 + 3a_2 - 3a_1/2 &= 0 \\ 20a_5 - 12a_4 + 9a_3 - 3a_2 + a_1/3 &= 0 \\ &\vdots \end{aligned}$$

Hence the general solution is

$$y(x) = a_0 + a_1x + (a_0 - a_1)\frac{x^3}{6} + (2a_0 + a_1)\frac{x^4}{24} + a_1\frac{7x^5}{120} + \left(\frac{5}{3}a_1 - a_0\right)\frac{x^6}{120} + \dots.$$

We find that two linearly independent solutions are

$$y_1(x) = 1 + \frac{x^3}{6} + \frac{x^4}{12} - \frac{x^6}{120} + \dots$$

$$y_2(x) = x - \frac{x^3}{6} + \frac{x^4}{24} + \frac{7x^5}{120} + \dots$$

The coefficient  $p(x) = e^x \ln(1+x)$  is analytic at  $x_0 = 0$ , but its power series has a radius of convergence  $\rho = 1$ .

15. If  $y_1 = x$  and  $y_2 = x^2$  are solutions, then substituting  $y_2$  into the ODE results in

$$2P(x) + 2xQ(x) + x^2R(x) = 0.$$

Setting  $x = 0$ , we find that  $P(0) = 0$ . Similarly, substituting  $y_1$  into the ODE results in  $Q(0) = 0$ . Therefore  $P(x)/Q(x)$  and  $R(x)/P(x)$  may not be analytic. If they were, Theorem 3.2.1 would guarantee that  $y_1$  and  $y_2$  were the *only* two solutions. But note that an *arbitrary* value of  $y(0)$  cannot be a linear combination of  $y_1(0)$  and  $y_2(0)$ . Hence  $x_0 = 0$  must be a singular point.

16. Let  $y = a_0 + a_1x + a_2x^2 + \cdots + a_nx^n + \cdots$ . Substituting into the ODE,

$$\sum_{n=0}^{\infty} (n+1)a_{n+1}x^n - \sum_{n=0}^{\infty} a_nx^n = 0.$$

That is,

$$\sum_{n=0}^{\infty} [(n+1)a_{n+1} - a_n]x^n = 0.$$

Setting the coefficients equal to *zero*, we obtain

$$a_{n+1} = \frac{a_n}{n+1}$$

for  $n = 0, 1, 2, \dots$ . It is easy to see that  $a_n = a_0/(n!)$ . Therefore the general solution is

$$\begin{aligned} y(x) &= a_0 \left[ 1 + x + \frac{x^2}{2!} + \frac{x^3}{3!} + \cdots \right] \\ &= a_0 e^x. \end{aligned}$$

The coefficient  $a_0 = y(0)$ , which can be arbitrary.

17. Let  $y = a_0 + a_1x + a_2x^2 + \cdots + a_nx^n + \cdots$ . Substituting into the ODE,

$$\sum_{n=0}^{\infty} (n+1)a_{n+1}x^n - x \sum_{n=0}^{\infty} a_nx^n = 0.$$

That is,

$$\sum_{n=0}^{\infty} (n+1)a_{n+1}x^n - \sum_{n=1}^{\infty} a_{n-1}x^n = 0.$$

Combining the series, we have

$$a_1 + \sum_{n=1}^{\infty} [(n+1)a_{n+1} - a_{n-1}] x^n = 0.$$

Setting the coefficient equal to zero,  $a_1 = 0$  and  $a_{n+1} = a_{n-1}/(n+1)$  for  $n = 1, 2, \dots$ . Note that the indices differ by two, so for  $k = 1, 2, \dots$

$$a_{2k} = \frac{a_{2k-2}}{(2k)} = \frac{a_{2k-4}}{(2k-2)(2k)} = \dots = \frac{a_0}{2 \cdot 4 \dots (2k)}$$

and

$$a_{2k+1} = 0.$$

Hence the general solution is

$$\begin{aligned} y(x) &= a_0 \left[ 1 + \frac{x^2}{2} + \frac{x^4}{2^2 2!} + \frac{x^6}{2^3 3!} + \dots + \frac{x^{2n}}{2^n n!} + \dots \right] \\ &= a_0 \exp(x^2/2). \end{aligned}$$

The coefficient  $a_0 = y(0)$ , which can be arbitrary.

19. Let  $y = a_0 + a_1x + a_2x^2 + \dots + a_nx^n + \dots$ . Substituting into the ODE,

$$(1-x) \sum_{n=0}^{\infty} (n+1)a_{n+1} x^n - \sum_{n=0}^{\infty} a_n x^n = 0.$$

That is,

$$\sum_{n=0}^{\infty} (n+1)a_{n+1} x^n - \sum_{n=1}^{\infty} n a_n x^n - \sum_{n=0}^{\infty} a_n x^n = 0.$$

Combining the series, we have

$$a_1 - a_0 + \sum_{n=1}^{\infty} [(n+1)a_{n+1} - n a_n - a_n] x^n = 0.$$

Setting the coefficients equal to zero,  $a_1 = a_0$  and  $a_{n+1} = a_n$  for  $n = 0, 1, 2, \dots$ . Hence the general solution is

$$\begin{aligned} y(x) &= a_0 [1 + x + x^2 + x^3 + \dots + x^n + \dots] \\ &= a_0 \frac{1}{1-x}. \end{aligned}$$

The coefficient  $a_0 = y(0)$ , which can be arbitrary.

21. Let  $y = a_0 + a_1x + a_2x^2 + \dots + a_nx^n + \dots$ . Substituting into the ODE,

$$\sum_{n=0}^{\infty} (n+1)a_{n+1}x^n + x \sum_{n=0}^{\infty} a_n x^n = 1 + x.$$

That is,

$$\sum_{n=0}^{\infty} (n+1)a_{n+1}x^n + \sum_{n=1}^{\infty} a_{n-1}x^n = 1 + x.$$

Combining the series, and the nonhomogeneous terms, we have

$$(a_1 - 1) + (2a_2 + a_0 - 1)x + \sum_{n=2}^{\infty} [(n+1)a_{n+1} + a_{n-1}]x^n = 0.$$

Setting the coefficients equal to *zero*, we obtain  $a_1 = 1$ ,  $2a_2 + a_0 - 1 = 0$ , and

$$a_n = -\frac{a_{n-2}}{n}, \quad n = 3, 4, \dots$$

The indices differ by *two*, so for  $k = 2, 3, \dots$

$$a_{2k} = -\frac{a_{2k-2}}{(2k)} = \frac{a_{2k-4}}{(2k-2)(2k)} = \dots = \frac{(-1)^{k-1}a_2}{4 \cdot 6 \cdot \dots \cdot (2k)} = \frac{(-1)^k(a_0 - 1)}{2 \cdot 4 \cdot 6 \cdot \dots \cdot (2k)},$$

and for  $k = 1, 2, \dots$

$$a_{2k+1} = -\frac{a_{2k-1}}{(2k+1)} = \frac{a_{2k-3}}{(2k-1)(2k+1)} = \dots = \frac{(-1)^k}{3 \cdot 5 \cdot \dots \cdot (2k+1)}.$$

Hence the general solution is

$$y(x) = a_0 + x + \frac{1-a_0}{2}x^2 - \frac{x^3}{3} + a_0 \frac{x^4}{2^2 2!} + \frac{x^5}{3 \cdot 5} - a_0 \frac{x^6}{2^3 3!} - \dots$$

Collecting the terms containing  $a_0$ ,

$$y(x) = a_0 \left[ 1 - \frac{x^2}{2} + \frac{x^4}{2^2 2!} - \frac{x^6}{2^3 3!} + \dots \right] + \left[ x + \frac{x^2}{2} - \frac{x^3}{3} - \frac{x^4}{2^2 2!} + \frac{x^5}{3 \cdot 5} + \frac{x^6}{2^3 3!} - \frac{x^7}{3 \cdot 5 \cdot 7} + \dots \right].$$

Upon inspection, we find that

$$y(x) = a_0 \exp(-x^2/2) + \left[ x + \frac{x^2}{2} - \frac{x^3}{3} - \frac{x^4}{2^2 2!} + \frac{x^5}{3 \cdot 5} + \frac{x^6}{2^3 3!} - \frac{x^7}{3 \cdot 5 \cdot 7} + \dots \right].$$

Note that the given ODE is *first order linear*, with integrating factor  $\mu(t) = e^{x^2/2}$ . The general solution is given by

$$y(x) = e^{-x^2/2} \int_0^x e^{u^2/2} du + (y(0) - 1)e^{-x^2/2} + 1.$$

23. If  $\alpha = 0$ , then  $y_1(x) = 1$ . If  $\alpha = 2n$ , then  $a_{2m} = 0$  for  $m \geq n + 1$ . As a result,

$$y_1(x) = 1 + \sum_{m=1}^n (-1)^m \frac{2^m n(n-1)\cdots(n-m+1)(2n+1)(2n+3)\cdots(2n+2m-1)}{(2m)!} x^{2m}.$$

$\alpha = 0$	1
$\alpha = 2$	$1 - 3x^2$
$\alpha = 4$	$1 - 10x^2 + \frac{35}{3}x^4$

If  $\alpha = 2n + 1$ , then  $a_{2m+1} = 0$  for  $m \geq n + 1$ . As a result,

$$y_2(x) = x + \sum_{m=1}^n (-1)^m \frac{2^m n(n-1)\cdots(n-m+1)(2n+3)(2n+5)\cdots(2n+2m+1)}{(2m+1)!} x^{2m+1}.$$

$\alpha = 1$	$x$
$\alpha = 3$	$x - \frac{5}{3}x^3$
$\alpha = 5$	$x - \frac{14}{3}x^3 + \frac{21}{5}x^5$

24(a). Based on Prob. 23,

$\alpha = 0$	1	$y_1(1) = 1$
$\alpha = 2$	$1 - 3x^2$	$y_1(1) = -2$
$\alpha = 4$	$1 - 10x^2 + \frac{35}{3}x^4$	$y_1(1) = \frac{8}{3}$

Normalizing the polynomials, we obtain

$$P_0(x) = 1$$

$$P_2(x) = -\frac{1}{2} + \frac{3}{2}x^2$$

$$P_4(x) = \frac{3}{8} - \frac{15}{4}x^2 + \frac{35}{8}x^4$$

$\alpha = 1$	$x$	$y_2(1) = 1$
$\alpha = 3$	$x - \frac{5}{3}x^3$	$y_2(1) = -\frac{2}{3}$
$\alpha = 5$	$x - \frac{14}{3}x^3 + \frac{21}{5}x^5$	$y_2(1) = \frac{8}{15}$

Similarly,

$$P_1(x) = x$$

$$P_3(x) = -\frac{3}{2}x + \frac{5}{2}x^3$$

$$P_5(x) = \frac{15}{8}x - \frac{35}{4}x^3 + \frac{63}{8}x^5$$

(b).

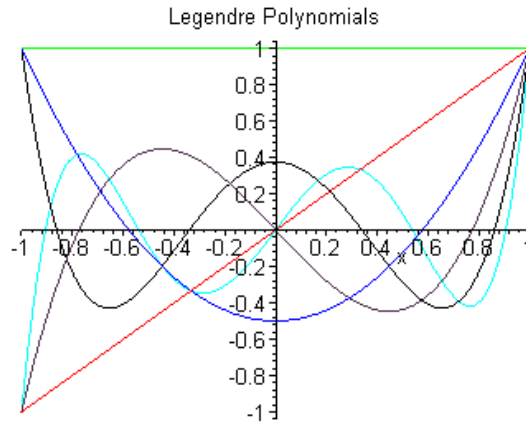

(c).  $P_0(x)$  has no roots.  $P_1(x)$  has one root at  $x = 0$ . The zeros of  $P_2(x)$  are at  $x = \pm 1/\sqrt{3}$ . The zeros of  $P_3(x)$  are  $x = 0, \pm\sqrt{3/5}$ . The roots of  $P_4(x)$  are given by  $x^2 = (15 + 2\sqrt{30})/35, (15 - 2\sqrt{30})/35$ . The roots of  $P_5(x)$  are given by  $x = 0$  and  $x^2 = (35 + 2\sqrt{70})/63, (35 - 2\sqrt{70})/63$ .

25. Observe that

$$\begin{aligned} P_n(-1) &= \frac{(-1)^n}{2^n} \sum_{k=0}^{\lfloor n/2 \rfloor} \frac{(-1)^k (2n-2k)!}{k!(n-k)!(n-2k)!} \\ &= (-1)^n P_n(1). \end{aligned}$$

But  $P_n(1) = 1$  for all nonnegative integers  $n$ .

27. We have

$$(x^2 - 1)^n = \sum_{k=0}^n \frac{(-1)^{n-k} n!}{k!(n-k)!} x^{2k},$$

which is a polynomial of degree  $2n$ . Differentiating  $n$  times,

$$\frac{d^n}{dx^n} (x^2 - 1)^n = \sum_{k=\mu}^n \frac{(-1)^{n-k} n!}{k!(n-k)!} (2k)(2k-1)\cdots(2k-n+1)x^{2k-n},$$

in which the lower index is  $\mu = \lfloor n/2 \rfloor + 1$ . Note that if  $n = 2m + 1$ , then  $\mu = m + 1$ .



Now shift the index, by setting

$$k = n - j.$$

Hence

$$\begin{aligned} \frac{d^n}{dx^n} (x^2 - 1)^n &= \sum_{j=0}^{\lfloor n/2 \rfloor} \frac{(-1)^j n!}{(n-j)! j!} (2n-2j)(2n-2j-1) \cdots (n-2j+1) x^{n-2j} \\ &= n! \sum_{j=0}^{\lfloor n/2 \rfloor} \frac{(-1)^j (2n-2j)!}{(n-j)! j! (n-2j)!} x^{n-2j}. \end{aligned}$$

Based on Prob. 25,

$$\frac{d^n}{dx^n} (x^2 - 1)^n = n! 2^n P_n(x).$$

29. Since the  $n + 1$  polynomials  $P_0, P_1, \dots, P_n$  are *linearly independent*, and the *degree* of  $P_k$  is  $k$ , any polynomial,  $f$ , of degree  $n$  can be expressed as a linear combination

$$f(x) = \sum_{k=0}^n a_k P_k(x).$$

Multiplying both sides by  $P_m$  and integrating,

$$\int_{-1}^1 f(x) P_m(x) dx = \sum_{k=0}^n a_k \int_{-1}^1 P_k(x) P_m(x) dx.$$

Based on Prob. 28,

$$\int_{-1}^1 P_k(x) P_m(x) dx = \frac{2}{2m+1} \delta_{km}.$$

Hence

$$\int_{-1}^1 f(x) P_m(x) dx = \frac{2}{2m+1} a_m.$$

### Section 5.4

2. We see that  $P(x) = 0$  when  $x = 0$  and  $1$ . Since the three coefficients have no factors in common, both of these points are singular points. Near  $x = 0$ ,

$$\lim_{x \rightarrow 0} x p(x) = \lim_{x \rightarrow 0} x \frac{2x}{x^2(1-x)^2} = 2.$$

$$\lim_{x \rightarrow 0} x^2 q(x) = \lim_{x \rightarrow 0} x^2 \frac{4}{x^2(1-x)^2} = 4.$$

The singular point  $x = 0$  is *regular*. Considering  $x = 1$ ,

$$\lim_{x \rightarrow 1} (x-1)p(x) = \lim_{x \rightarrow 1} (x-1) \frac{2x}{x^2(1-x)^2}.$$

The latter limit *does not exist*. Hence  $x = 1$  is an *irregular* singular point.

3.  $P(x) = 0$  when  $x = 0$  and  $1$ . Since the three coefficients have no common factors, both of these points are singular points. Near  $x = 0$ ,

$$\lim_{x \rightarrow 0} x p(x) = \lim_{x \rightarrow 0} x \frac{x-2}{x^2(1-x)}.$$

The limit *does not exist*, and so  $x = 0$  is an *irregular* singular point. Considering  $x = 1$ ,

$$\lim_{x \rightarrow 1} (x-1)p(x) = \lim_{x \rightarrow 1} (x-1) \frac{x-2}{x^2(1-x)} = 1.$$

$$\lim_{x \rightarrow 1} (x-1)^2 q(x) = \lim_{x \rightarrow 1} (x-1)^2 \frac{-3x}{x^2(1-x)} = 0.$$

Hence  $x = 1$  is a *regular* singular point.

4.  $P(x) = 0$  when  $x = 0$  and  $\pm 1$ . Since the three coefficients have no common factors, both of these points are singular points. Near  $x = 0$ ,

$$\lim_{x \rightarrow 0} x p(x) = \lim_{x \rightarrow 0} x \frac{2}{x^3(1-x^2)}.$$

The limit *does not exist*, and so  $x = 0$  is an *irregular* singular point. Near  $x = -1$ ,

$$\lim_{x \rightarrow -1} (x+1)p(x) = \lim_{x \rightarrow -1} (x+1) \frac{2}{x^3(1-x^2)} = -1.$$

$$\lim_{x \rightarrow -1} (x+1)^2 q(x) = \lim_{x \rightarrow -1} (x+1)^2 \frac{2}{x^3(1-x^2)} = 0.$$

Hence  $x = -1$  is a *regular* singular point. At  $x = 1$ ,

$$\lim_{x \rightarrow 1} (x-1)p(x) = \lim_{x \rightarrow 1} (x-1) \frac{2}{x^3(1-x^2)} = -1.$$

$$\lim_{x \rightarrow 1} (x-1)^2 q(x) = \lim_{x \rightarrow 1} (x-1)^2 \frac{2}{x^3(1-x^2)} = 0.$$

Hence  $x = 1$  is a *regular* singular point.

6. The only singular point is at  $x = 0$ . We find that

$$\lim_{x \rightarrow 0} x p(x) = \lim_{x \rightarrow 0} x \frac{x}{x^2} = 1.$$

$$\lim_{x \rightarrow 0} x^2 q(x) = \lim_{x \rightarrow 0} x^2 \frac{x^2 - \nu^2}{x^2} = -\nu^2.$$

Hence  $x = 0$  is a *regular* singular point.

7. The only singular point is at  $x = -3$ . We find that

$$\lim_{x \rightarrow -3} (x+3)p(x) = \lim_{x \rightarrow -3} (x+3) \frac{-2x}{x+3} = 6.$$

$$\lim_{x \rightarrow -3} (x+3)^2 q(x) = \lim_{x \rightarrow -3} (x+3)^2 \frac{1-x^2}{x+3} = 0.$$

Hence  $x = -3$  is a *regular* singular point.

8. Dividing the ODE by  $x(1-x^2)^3$ , we find that

$$p(x) = \frac{1}{x(1-x^2)} \quad \text{and} \quad q(x) = \frac{2}{x(1+x)^2(1-x)^3}.$$

The singular points are at  $x = 0$  and  $\pm 1$ . For  $x = 0$ ,

$$\lim_{x \rightarrow 0} x p(x) = \lim_{x \rightarrow 0} x \frac{1}{x(1-x^2)} = 1.$$

$$\lim_{x \rightarrow 0} x^2 q(x) = \lim_{x \rightarrow 0} x^2 \frac{2}{x(1+x)^2(1-x)^3} = 0.$$

Hence  $x = 0$  is a *regular* singular point. For  $x = -1$ ,

$$\lim_{x \rightarrow -1} (x+1)p(x) = \lim_{x \rightarrow -1} (x+1) \frac{1}{x(1-x^2)} = -\frac{1}{2}.$$

$$\lim_{x \rightarrow -1} (x+1)^2 q(x) = \lim_{x \rightarrow -1} (x+1)^2 \frac{2}{x(1+x)^2(1-x)^3} = -\frac{1}{4}.$$

Hence  $x = -1$  is a *regular* singular point. For  $x = 1$ ,

$$\lim_{x \rightarrow 1} (x-1)p(x) = \lim_{x \rightarrow 1} (x-1) \frac{1}{x(1-x^2)} = -\frac{1}{2}.$$

$$\lim_{x \rightarrow 1} (x-1)^2 q(x) = \lim_{x \rightarrow 1} (x-1)^2 \frac{2}{x(1+x)^2(1-x)^3}.$$

The latter limit *does not exist*. Hence  $x = 1$  is an *irregular* singular point.

9. Dividing the ODE by  $(x+2)^2(x-1)$ , we find that

$$p(x) = \frac{3}{(x+2)^2} \quad \text{and} \quad q(x) = \frac{-2}{(x+2)(x-1)}.$$

The singular points are at  $x = -2$  and  $1$ . For  $x = -2$ ,

$$\lim_{x \rightarrow -2} (x+2)p(x) = \lim_{x \rightarrow -2} (x+2) \frac{3}{(x+2)^2}.$$

The limit *does not exist*. Hence  $x = -2$  is an *irregular* singular point. For  $x = 1$ ,

$$\lim_{x \rightarrow 1} (x-1)p(x) = \lim_{x \rightarrow 1} (x-1) \frac{3}{(x+2)^2} = 0.$$

$$\lim_{x \rightarrow 1} (x-1)^2 q(x) = \lim_{x \rightarrow 1} (x-1)^2 \frac{-2}{(x+2)(x-1)} = 0.$$

Hence  $x = 1$  is a *regular* singular point.

10.  $P(x) = 0$  when  $x = 0$  and  $3$ . Since the three coefficients have no common factors, both of these points are singular points. Near  $x = 0$ ,

$$\lim_{x \rightarrow 0} x p(x) = \lim_{x \rightarrow 0} x \frac{x+1}{x(3-x)} = \frac{1}{3}.$$

$$\lim_{x \rightarrow 0} x^2 q(x) = \lim_{x \rightarrow 0} x^2 \frac{-2}{x(3-x)} = 0.$$

Hence  $x = 0$  is a *regular* singular point. For  $x = 3$ ,

$$\lim_{x \rightarrow 3} (x-3)p(x) = \lim_{x \rightarrow 3} (x-3) \frac{x+1}{x(3-x)} = -\frac{4}{3}.$$

$$\lim_{x \rightarrow 3} (x-3)^2 q(x) = \lim_{x \rightarrow 3} (x-3)^2 \frac{-2}{x(3-x)} = 0.$$

Hence  $x = 3$  is a *regular* singular point.

11. Dividing the ODE by  $(x^2 + x - 2)$ , we find that

$$p(x) = \frac{x+1}{(x+2)(x-1)} \quad \text{and} \quad q(x) = \frac{2}{(x+2)(x-1)}.$$

The singular points are at  $x = -2$  and  $1$ . For  $x = -2$ ,

$$\lim_{x \rightarrow -2} (x+2)p(x) = \lim_{x \rightarrow -2} \frac{x+1}{x-1} = \frac{1}{3}.$$

$$\lim_{x \rightarrow -2} (x+2)^2 q(x) = \lim_{x \rightarrow -2} \frac{2(x+2)}{x-1} = 0.$$

Hence  $x = -2$  is a *regular* singular point. For  $x = 1$ ,

$$\lim_{x \rightarrow 1} (x-1)p(x) = \lim_{x \rightarrow 1} \frac{x+1}{x+2} = \frac{2}{3}.$$

$$\lim_{x \rightarrow 1} (x-1)^2 q(x) = \lim_{x \rightarrow 1} \frac{2(x-1)}{(x+2)} = 0.$$

Hence  $x = 1$  is a *regular* singular point.

13. Note that  $p(x) = \ln|x|$  and  $q(x) = 3x$ . Evidently,  $p(x)$  is *not* analytic at  $x_0 = 0$ . Furthermore, the function  $x p(x) = x \ln|x|$  does *not* have a Taylor series about  $x_0 = 0$ . Hence  $x = 0$  is an *irregular* singular point.

14.  $P(x) = 0$  when  $x = 0$ . Since the three coefficients have no common factors,  $x = 0$  is a singular point. The Taylor series of  $e^x - 1$ , about  $x = 0$ , is

$$e^x - 1 = x + x^2/2 + x^3/6 + \dots.$$

Hence the function  $x p(x) = 2(e^x - 1)/x$  is analytic at  $x = 0$ . Similarly, the Taylor series of  $e^{-x} \cos x$ , about  $x = 0$ , is

$$e^{-x} \cos x = 1 - x + x^3/3 - x^4/6 + \dots.$$

The function  $x^2 q(x) = e^{-x} \cos x$  is also analytic at  $x = 0$ . Hence  $x = 0$  is a *regular* singular point.

15.  $P(x) = 0$  when  $x = 0$ . Since the three coefficients have no common factors,  $x = 0$  is a singular point. The Taylor series of  $\sin x$ , about  $x = 0$ , is

$$\sin x = x - x^3/3! + x^5/5! - \dots.$$

Hence the function  $x p(x) = -3\sin x/x$  is analytic at  $x = 0$ . On the other hand,  $q(x)$  is a rational function, with

$$\lim_{x \rightarrow 0} x^2 q(x) = \lim_{x \rightarrow 0} x^2 \frac{1+x^2}{x^2} = 1.$$

Hence  $x = 0$  is a *regular* singular point.

16.  $P(x) = 0$  when  $x = 0$ . Since the three coefficients have no common factors,  $x = 0$  is a singular point. We find that

$$\lim_{x \rightarrow 0} x p(x) = \lim_{x \rightarrow 0} x \frac{1}{x} = 1.$$

Although the function  $R(x) = \cot x$  does not have a Taylor series about  $x = 0$ , note that  $x^2 q(x) = x \cot x = 1 - x^2/3 - x^4/45 - 2x^6/945 - \dots$ . Hence  $x = 0$  is a *regular* singular point. Furthermore,  $q(x) = \cot x/x^2$  is undefined at  $x = \pm n\pi$ . Therefore the points  $x = \pm n\pi$  are *also* singular points. First note that

$$\lim_{x \rightarrow \pm n\pi} (x \mp n\pi) p(x) = \lim_{x \rightarrow \pm n\pi} (x \mp n\pi) \frac{1}{x} = 0.$$

Furthermore, since  $\cot x$  has period  $\pi$ ,

$$\begin{aligned} q(x) &= \cot x/x = \cot(x \mp n\pi)/x \\ &= \cot(x \mp n\pi) \frac{1}{(x \mp n\pi) \pm n\pi}. \end{aligned}$$

Therefore

$$(x \mp n\pi)^2 q(x) = (x \mp n\pi) \cot(x \mp n\pi) \left[ \frac{(x \mp n\pi)}{(x \mp n\pi) \pm n\pi} \right].$$

From above,

$$(x \mp n\pi) \cot(x \mp n\pi) = 1 - (x \mp n\pi)^2/3 - (x \mp n\pi)^4/45 - \dots.$$

Note that the function in *brackets* is analytic near  $x = \pm n\pi$ . It follows that the function  $(x \mp n\pi)^2 q(x)$  is also analytic near  $x = \pm n\pi$ . Hence all the singular points are *regular*.

18. The singular points are located at  $x = \pm n\pi$ ,  $n = 0, 1, \dots$ . Dividing the ODE by  $x \sin x$ , we find that  $x p(x) = 3 \csc x$  and  $x^2 q(x) = x^2 \csc x$ . Evidently,  $x p(x)$  is not even defined at  $x = 0$ . Hence  $x = 0$  is an *irregular* singular point. On the other hand, the Taylor series of  $x \csc x$ , about  $x = 0$ , is

$$x \csc x = 1 + x^2/6 + 7x^4/360 + \dots.$$

Noting that  $\csc(x \mp n\pi) = (-1)^n \csc x$ ,

$$\begin{aligned} (x \mp n\pi)p(x) &= 3(-1)^n(x \mp n\pi)\csc(x \mp n\pi)/x \\ &= 3(-1)^n(x \mp n\pi)\csc(x \mp n\pi) \left[ \frac{1}{(x \mp n\pi) \pm n\pi} \right]. \end{aligned}$$

It is apparent that  $(x \mp n\pi)p(x)$  is analytic at  $x = \pm n\pi$ . Similarly,

$$\begin{aligned} (x \mp n\pi)^2 q(x) &= (x \mp n\pi)^2 \csc x \\ &= (-1)^n (x \mp n\pi)^2 \csc(x \mp n\pi), \end{aligned}$$

which is also analytic at  $x = \pm n\pi$ . Hence all other singular points are *regular*.

20.  $x = 0$  is the only singular point. Dividing the ODE by  $2x^2$ , we have  $p(x) = 3/(2x)$  and  $q(x) = -x^{-2}(1+x)/2$ . It follows that

$$\lim_{x \rightarrow 0} x p(x) = \lim_{x \rightarrow 0} x \frac{3}{2x} = \frac{3}{2},$$

$$\lim_{x \rightarrow 0} x^2 q(x) = \lim_{x \rightarrow 0} x^2 \frac{-(1+x)}{2x^2} = -\frac{1}{2}.$$

Hence  $x = 0$  is a *regular* singular point. Let  $y = a_0 + a_1x + a_2x^2 + \dots + a_nx^n + \dots$ . Substitution into the ODE results in

$$2x^2 \sum_{n=0}^{\infty} (n+2)(n+1)a_{n+2}x^n + 3x \sum_{n=0}^{\infty} (n+1)a_{n+1}x^n - (1+x) \sum_{n=0}^{\infty} a_nx^n = 0.$$

That is,

$$2 \sum_{n=2}^{\infty} n(n-1)a_nx^n + 3 \sum_{n=1}^{\infty} n a_nx^n - \sum_{n=0}^{\infty} a_nx^n - \sum_{n=1}^{\infty} a_{n-1}x^n = 0.$$

It follows that

$$-a_0 + (2a_1 - a_0)x + \sum_{n=2}^{\infty} [2n(n-1)a_n + 3n a_n - a_n - a_{n-1}]x^n = 0.$$

Equating the coefficients to *zero*, we find that  $a_0 = 0$ ,  $2a_1 - a_0 = 0$ , and

$$(2n-1)(n+1)a_n = a_{n-1}, \quad n = 2, 3, \dots.$$

We conclude that *all* the  $a_n$  are *equal to zero*. Hence  $y(x) = 0$  is the only solution that can be obtained.

22. Based on Prob. 21, the change of variable,  $x = 1/\xi$ , transforms the ODE into the

form

$$\xi^4 \frac{d^2 y}{d\xi^2} + 2\xi^3 \frac{dy}{d\xi} + y = 0.$$

Evidently,  $\xi = 0$  is a singular point. Now  $p(\xi) = 2/\xi$  and  $q(\xi) = 1/\xi^4$ . Since the value of  $\lim_{\xi \rightarrow 0} \xi^2 q(\xi)$  does not exist,  $\xi = 0$ , that is,  $x = \infty$ , is an *irregular* singular point.

24. Under the transformation  $x = 1/\xi$ , the ODE becomes

$$\xi^4 \left(1 - \frac{1}{\xi^2}\right) \frac{d^2 y}{d\xi^2} + \left[2\xi^3 \left(1 - \frac{1}{\xi^2}\right) + 2\xi^2 \frac{1}{\xi}\right] \frac{dy}{d\xi} + \alpha(\alpha + 1)y = 0,$$

that is,

$$(\xi^4 - \xi^2) \frac{d^2 y}{d\xi^2} + 2\xi^3 \frac{dy}{d\xi} + \alpha(\alpha + 1)y = 0.$$

Therefore  $\xi = 0$  is a singular point. Note that

$$p(\xi) = \frac{2\xi}{\xi^2 - 1} \text{ and } q(\xi) = \frac{\alpha(\alpha + 1)}{\xi^2(\xi^2 - 1)}.$$

It follows that

$$\lim_{\xi \rightarrow 0} \xi p(\xi) = \lim_{\xi \rightarrow 0} \xi \frac{2\xi}{\xi^2 - 1} = 0,$$

$$\lim_{\xi \rightarrow 0} \xi^2 q(\xi) = \lim_{\xi \rightarrow 0} \xi^2 \frac{\alpha(\alpha + 1)}{\xi^2(\xi^2 - 1)} = -\alpha(\alpha + 1).$$

Hence  $\xi = 0$  ( $x = \infty$ ) is a *regular* singular point.

26. Under the transformation  $x = 1/\xi$ , the ODE becomes

$$\xi^4 \frac{d^2 y}{d\xi^2} + \left[2\xi^3 + 2\xi^2 \frac{1}{\xi}\right] \frac{dy}{d\xi} + \lambda y = 0,$$

that is,

$$\xi^4 \frac{d^2 y}{d\xi^2} + 2(\xi^3 + \xi) \frac{dy}{d\xi} + \lambda y = 0.$$

Therefore  $\xi = 0$  is a singular point. Note that

$$p(\xi) = \frac{2(\xi^2 + 1)}{\xi^3} \text{ and } q(\xi) = \frac{\lambda}{\xi^4}.$$

It immediately follows that the limit  $\lim_{\xi \rightarrow 0} \xi p(\xi)$  does not exist. Hence  $\xi = 0$  ( $x = \infty$ )



is an *irregular* singular point.

27. Under the transformation  $x = 1/\xi$ , the ODE becomes

$$\xi^4 \frac{d^2 y}{d\xi^2} + 2\xi^3 \frac{dy}{d\xi} - \frac{1}{\xi} y = 0.$$

Therefore  $\xi = 0$  is a singular point. Note that

$$p(\xi) = \frac{2}{\xi} \text{ and } q(\xi) = \frac{-1}{\xi^5}.$$

We find that

$$\lim_{\xi \rightarrow 0} \xi p(\xi) = \lim_{\xi \rightarrow 0} \xi \frac{2}{\xi} = 2,$$

but

$$\lim_{\xi \rightarrow 0} \xi^2 q(\xi) = \lim_{\xi \rightarrow 0} \xi^2 \frac{(-1)}{\xi^5}.$$

The latter limit *does not exist*. Hence  $\xi = 0$  ( $x = \infty$ ) is an *irregular* singular point.

## Section 5.5

1. Substitution of  $y = x^r$  results in the quadratic equation  $F(r) = 0$ , where

$$\begin{aligned} F(r) &= r(r-1) + 4r + 2 \\ &= r^2 + 3r + 2. \end{aligned}$$

The roots are  $r = -2, -1$ . Hence the general solution, for  $x \neq 0$ , is

$$y = c_1 x^{-2} + c_2 x^{-1}.$$

3. Substitution of  $y = x^r$  results in the quadratic equation  $F(r) = 0$ , where

$$\begin{aligned} F(r) &= r(r-1) - 3r + 4 \\ &= r^2 - 4r + 4. \end{aligned}$$

The root is  $r = 2$ , with multiplicity *two*. Hence the general solution, for  $x \neq 0$ , is

$$y = (c_1 + c_2 \ln|x|) x^2.$$

5. Substitution of  $y = x^r$  results in the quadratic equation  $F(r) = 0$ , where

$$\begin{aligned} F(r) &= r(r-1) - r + 1 \\ &= r^2 - 2r + 1. \end{aligned}$$

The root is  $r = 1$ , with multiplicity *two*. Hence the general solution, for  $x \neq 0$ , is

$$y = (c_1 + c_2 \ln|x|) x.$$

6. Substitution of  $y = (x-1)^r$  results in the quadratic equation  $F(r) = 0$ , where

$$F(r) = r^2 + 7r + 12.$$

The roots are  $r = -3, -4$ . Hence the general solution, for  $x \neq 1$ , is

$$y = c_1 (x-1)^{-3} + c_2 (x-1)^{-4}.$$

7. Substitution of  $y = x^r$  results in the quadratic equation  $F(r) = 0$ , where

$$F(r) = r^2 + 5r - 1.$$

The roots are  $r = -\left(\frac{5 \pm \sqrt{29}}{2}\right)$ . Hence the general solution, for  $x \neq 0$ , is

$$y = c_1 |x|^{-\left(\frac{5 + \sqrt{29}}{2}\right)} + c_2 |x|^{-\left(\frac{5 - \sqrt{29}}{2}\right)}.$$

8. Substitution of  $y = x^r$  results in the quadratic equation  $F(r) = 0$ , where

$$F(r) = r^2 - 3r + 3.$$

The roots are complex, with  $r = (3 \pm i\sqrt{3})/2$ . Hence the general solution, for  $x \neq 0$ , is

$$y = c_1 |x|^{3/2} \cos\left(\frac{\sqrt{3}}{2} \ln|x|\right) + c_2 |x|^{3/2} \sin\left(\frac{\sqrt{3}}{2} \ln|x|\right).$$

10. Substitution of  $y = (x - 2)^r$  results in the quadratic equation  $F(r) = 0$ , where

$$F(r) = r^2 + 4r + 8.$$

The roots are complex, with  $r = -2 \pm 2i$ . Hence the general solution, for  $x \neq 2$ , is

$$y = c_1 (x - 2)^{-2} \cos(2 \ln|x - 2|) + c_2 (x - 2)^{-2} \sin(2 \ln|x - 2|).$$

11. Substitution of  $y = x^r$  results in the quadratic equation  $F(r) = 0$ , where

$$F(r) = r^2 + r + 4.$$

The roots are complex, with  $r = -(1 \pm i\sqrt{15})/2$ . Hence the general solution, for  $x \neq 0$ , is

$$y = c_1 |x|^{-1/2} \cos\left(\frac{\sqrt{15}}{2} \ln|x|\right) + c_2 |x|^{-1/2} \sin\left(\frac{\sqrt{15}}{2} \ln|x|\right).$$

12. Substitution of  $y = x^r$  results in the quadratic equation  $F(r) = 0$ , where

$$F(r) = r^2 - 5r + 4.$$

The roots are  $r = 1, 4$ . Hence the general solution, for  $x \neq 0$ , is

$$y = c_1 x + c_2 x^4.$$

14. Substitution of  $y = x^r$  results in the quadratic equation  $F(r) = 0$ , where

$$F(r) = 4r^2 + 4r + 17.$$

The roots are complex, with  $r = -1/2 \pm 2i$ . Hence the general solution, for  $x > 0$ , is

$$y = c_1 x^{-1/2} \cos(2 \ln x) + c_2 x^{-1/2} \sin(2 \ln x).$$

Invoking the initial conditions, we obtain the system of equations

$$\begin{aligned} c_1 &= 2 \\ -\frac{1}{2}c_1 + 2c_2 &= -3 \end{aligned}$$

Hence the solution of the initial value problem is

$$y(x) = 2x^{-1/2}\cos(2\ln x) - x^{-1/2}\sin(2\ln x).$$

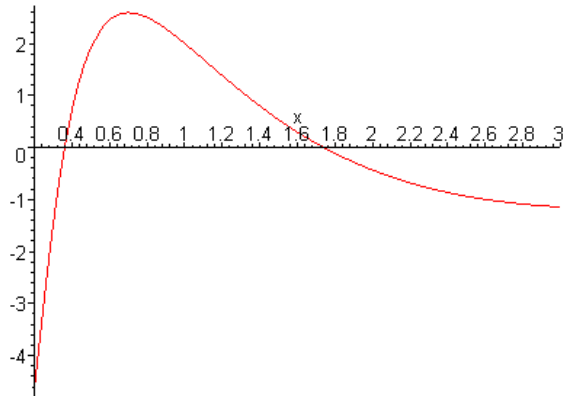

As  $x \rightarrow 0^+$ , the solution decreases without bound.

15. Substitution of  $y = x^r$  results in the quadratic equation  $F(r) = 0$ , where

$$F(r) = r^2 - 4r + 4.$$

The root is  $r = 2$ , with multiplicity *two*. Hence the general solution, for  $x < 0$ , is

$$y = (c_1 + c_2 \ln |x|) x^2.$$

Invoking the initial conditions, we obtain the system of equations

$$\begin{aligned} c_1 &= 2 \\ -2c_1 - c_2 &= 3 \end{aligned}$$

Hence the solution of the initial value problem is

$$y(x) = (2 - 7 \ln |x|) x^2.$$

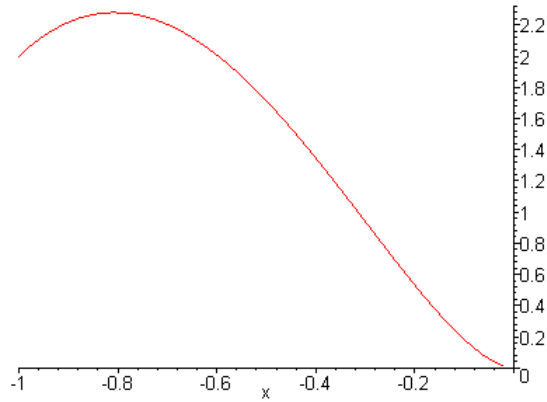

We find that  $y(x) \rightarrow 0$  as  $x \rightarrow 0^-$ .

18. Substitution of  $y = x^r$  results in the quadratic equation  $r^2 - r + \beta = 0$ . The roots are

$$r = \frac{1 \pm \sqrt{1 - 4\beta}}{2}.$$

If  $\beta > 1/4$ , the roots are complex, with  $r_{1,2} = (1 \pm i\sqrt{4\beta - 1})/2$ . Hence the general solution, for  $x \neq 0$ , is

$$y = c_1 |x|^{1/2} \cos\left(\frac{1}{2} \sqrt{4\beta - 1} \ln|x|\right) + c_2 |x|^{1/2} \sin\left(\frac{1}{2} \sqrt{4\beta - 1} \ln|x|\right).$$

Since the trigonometric factors are *bounded*,  $y(x) \rightarrow 0$  as  $x \rightarrow 0$ . If  $\beta = 1/4$ , the roots are *equal*, and

$$y = c_1 |x|^{1/2} + c_2 |x|^{1/2} \ln|x|.$$

Since  $\lim_{x \rightarrow 0} \sqrt{|x|} \ln|x| = 0$ ,  $y(x) \rightarrow 0$  as  $x \rightarrow 0$ . If  $\beta < 1/4$ , the roots are real, with  $r_{1,2} = (1 \pm \sqrt{1 - 4\beta})/2$ . Hence the general solution, for  $x \neq 0$ , is

$$y = c_1 |x|^{1/2 + \sqrt{1 - 4\beta}/2} + c_2 |x|^{1/2 - \sqrt{1 - 4\beta}/2}.$$

Evidently, solutions approach *zero* as long as  $1/2 - \sqrt{1 - 4\beta}/2 > 0$ . That is,

$$0 < \beta < 1/4.$$

Hence *all* solutions approach *zero*, for  $\beta > 0$ .

19. Substitution of  $y = x^r$  results in the quadratic equation  $r^2 - r - 2 = 0$ . The roots are  $r = -1, 2$ . Hence the general solution, for  $x \neq 0$ , is

$$y = c_1 x^{-1} + c_2 x^2.$$

Invoking the initial conditions, we obtain the system of equations

$$\begin{aligned}c_1 + c_2 &= 1 \\ -c_1 + 2c_2 &= \gamma\end{aligned}$$

Hence the solution of the initial value problem is

$$y(x) = \frac{2 - \gamma}{3}x^{-1} + \frac{1 + \gamma}{3}x^2.$$

The solution is *bounded*, as  $x \rightarrow 0$ , if  $\gamma = 2$ .

20. Substitution of  $y = x^r$  results in the quadratic equation  $r^2 + (\alpha - 1)r + 5/2 = 0$ . Formally, the roots are given by

$$\begin{aligned}r &= \frac{1 - \alpha \pm \sqrt{\alpha^2 - 2\alpha - 9}}{2} \\ &= \frac{1 - \alpha \pm \sqrt{(\alpha - 1 - \sqrt{10})(\alpha - 1 + \sqrt{10})}}{2}.\end{aligned}$$

(i) The roots  $r_{1,2}$  will be *complex*, if  $|1 - \alpha| < \sqrt{10}$ . For solutions to approach *zero*, as  $x \rightarrow \infty$ , we need  $-\sqrt{10} < 1 - \alpha < 0$ .

(ii) The roots will be *equal*, if  $|1 - \alpha| = \sqrt{10}$ . In this case, all solutions approach *zero* as long as  $1 - \alpha = -\sqrt{10}$ .

(iii) The roots will be real and *distinct*, if  $|1 - \alpha| > \sqrt{10}$ . It follows that

$$r_{max} = \frac{1 - \alpha + \sqrt{\alpha^2 - 2\alpha - 9}}{2}.$$

For solutions to approach *zero*, we need  $1 - \alpha + \sqrt{\alpha^2 - 2\alpha - 9} < 0$ . That is,  $1 - \alpha < -\sqrt{10}$ .

Hence all solutions approach *zero*, as  $x \rightarrow \infty$ , as long as  $\alpha > 1$ .

23(a). Given that  $x = e^z$ ,  $y(x) = y(e^z) = w(z)$ . By the chain rule,

$$\frac{dy}{dx} = \frac{d}{dx}w(z) = \frac{dw}{dz} \frac{dz}{dx} = \frac{1}{x} \frac{dw}{dz}.$$

Similarly,

$$\begin{aligned}\frac{d^2y}{dx^2} &= \frac{d}{dx} \left[ \frac{1}{x} \frac{dw}{dz} \right] = -\frac{1}{x^2} \frac{dw}{dz} + \frac{1}{x} \frac{d^2w}{dz^2} \frac{dz}{dx} \\ &= -\frac{1}{x^2} \frac{dw}{dz} + \frac{1}{x^2} \frac{d^2w}{dz^2}.\end{aligned}$$

(b). Direct substitution results in

$$x^2 \left[ \frac{1}{x^2} \frac{d^2 w}{dz^2} - \frac{1}{x^2} \frac{dw}{dz} \right] + \alpha x \left[ \frac{1}{x} \frac{dw}{dz} \right] + \beta w = 0,$$

that is,

$$\frac{d^2 w}{dz^2} + (\alpha - 1) \frac{dw}{dz} + \beta w = 0.$$

The associated *characteristic equation* is  $r^2 + (\alpha - 1)r + \beta = 0$ . Since  $z = \ln x$ , it follows that  $y(x) = w(\ln x)$ .

(c). If the roots  $r_{1,2}$  are real and *distinct*, then

$$\begin{aligned} y &= c_1 e^{r_1 z} + c_2 e^{r_2 z} \\ &= c_1 x^{r_1} + c_2 x^{r_2}. \end{aligned}$$

(d). If the roots  $r_{1,2}$  are real and *equal*, then

$$\begin{aligned} y &= c_1 e^{r_1 z} + c_2 z e^{r_1 z} \\ &= c_1 x^{r_1} + c_2 x^{r_1} \ln x. \end{aligned}$$

(e). If the roots are *complex conjugates*, then  $r = \lambda \pm i\mu$ , and

$$\begin{aligned} y &= e^{\lambda z} (c_1 \cos \mu z + c_2 \sin \mu z) \\ &= x^\lambda [c_1 \cos(\mu \ln x) + c_2 \sin(\mu \ln x)]. \end{aligned}$$

24. Based on Prob. 23, the change of variable  $x = e^z$  transforms the ODE into

$$\frac{d^2 w}{dz^2} - \frac{dw}{dz} - 2w = 0.$$

The associated *characteristic equation* is  $r^2 - r - 2 = 0$ , with roots  $r = -1, 2$ . Hence  $w(z) = c_1 e^{-z} + c_2 e^{2z}$ , and  $y(x) = c_1 x^{-1} + c_2 x^2$ .

26. The change of variable  $x = e^z$  transforms the ODE into

$$\frac{d^2 w}{dz^2} + 6 \frac{dw}{dz} + 5w = e^z.$$

The associated *characteristic equation* is  $r^2 + 6r + 5 = 0$ , with roots  $r = -5, -1$ . Hence  $w_c(z) = c_1 e^{-z} + c_2 e^{-5z}$ . Since the right hand side is *not* a solution of the homogeneous equation, we can use the *method of undetermined coefficients* to show that a particular solution is  $W = e^z/12$ . Therefore the general solution is given by  $w(z) = c_1 e^{-z} + c_2 e^{-5z} + e^z/12$ , that is,  $y(x) = c_1 x^{-1} + c_2 x^{-5} + x/12$ .

27. The change of variable  $x = e^z$  transforms the given ODE into

$$\frac{d^2w}{dz^2} - 3\frac{dw}{dz} + 2w = 3e^{2z} + 2z.$$

The associated *characteristic equation* is  $r^2 - 3r + 2 = 0$ , with roots  $r = 1, 2$ . Hence  $w_c(z) = c_1e^z + c_2e^{2z}$ . Using the *method of undetermined coefficients*, let  $W = Ae^{2z} + Bze^{2z} + Cz + D$ . It follows that the general solution is given by  $w(z) = c_1e^z + c_2e^{2z} + 3ze^{2z} + z + 3/2$ , that is,

$$y(x) = c_1x + c_2x^2 + 3x^2\ln x + \ln x + 3/2.$$

28. The change of variable  $x = e^z$  transforms the given ODE into

$$\frac{d^2w}{dz^2} + 4w = \sin z.$$

The solution of the homogeneous equation is  $w_c(z) = c_1\cos 2z + c_2\sin 2z$ . The right hand side is *not* a solution of the homogeneous equation. We can use the *method of undetermined coefficients* to show that a particular solution is  $W = \frac{1}{3}\sin z$ . Hence the general solution is given by  $w(z) = c_1\cos 2z + c_2\sin 2z + \frac{1}{3}\sin z$ , that is,  $y(x) = c_1\cos(2\ln x) + c_2\sin(2\ln x) + \frac{1}{3}\sin(\ln x)$ .

29. After dividing the equation by 3, the change of variable  $x = e^z$  transforms the ODE into

$$\frac{d^2w}{dz^2} + 3\frac{dw}{dz} + 3w = 0.$$

The associated *characteristic equation* is  $r^2 + 3r + 3 = 0$ , with complex roots  $r = -\left(3 \pm i\sqrt{3}\right)/2$ . Hence the general solution is

$$w(z) = e^{-3z/2} \left[ c_1\cos\left(\frac{\sqrt{3}}{2}z/2\right) + c_2\sin\left(\frac{\sqrt{3}}{2}z/2\right) \right],$$

and therefore

$$y(x) = x^{-3/2} \left[ c_1\cos\left(\frac{\sqrt{3}}{2}\ln x\right) + c_2\sin\left(\frac{\sqrt{3}}{2}\ln x\right) \right].$$

30. Let  $x < 0$ . Setting  $y = (-x)^r$ , successive differentiation gives  $y' = -r(-x)^{r-1}$  and  $y'' = r(r-1)(-x)^{r-2}$ . It follows that

$$L[(-x)^r] = r(r-1)x^2(-x)^{r-2} - \alpha r x(-x)^{r-1} + \beta(-x)^r.$$

Since  $x^2 = (-x)^2$ , we find that



$$\begin{aligned}L[(-x)^r] &= r(r-1)(-x)^r + \alpha r(-x)^r + \beta(-x)^r \\ &= (-x)^r[r(r-1) + \alpha r + \beta].\end{aligned}$$

Given that  $r_1$  and  $r_2$  are roots of  $F(r) = r(r-1) + \alpha r + \beta$ , we have  $L[(-x)^{r_i}] = 0$ . Therefore  $y_1 = (-x)^{r_1}$  and  $y_2 = (-x)^{r_2}$  are *linearly independent* solutions of the differential equation,  $L[y] = 0$ , for  $x < 0$ , as long as  $r_1 \neq r_2$ .

### Section 5.6

1.  $P(x) = 0$  when  $x = 0$ . Since the three coefficients have no common factors,  $x = 0$  is a singular point. Near  $x = 0$ ,

$$\lim_{x \rightarrow 0} x p(x) = \lim_{x \rightarrow 0} x \frac{1}{2x} = \frac{1}{2}.$$

$$\lim_{x \rightarrow 0} x^2 q(x) = \lim_{x \rightarrow 0} x^2 \frac{1}{2} = 0.$$

Hence  $x = 0$  is a *regular* singular point. Let

$$y = x^r (a_0 + a_1 x + a_2 x^2 + \cdots + a_n x^n + \cdots) = \sum_{n=0}^{\infty} a_n x^{r+n}.$$

Then

$$y' = \sum_{n=0}^{\infty} (r+n) a_n x^{r+n-1}$$

and

$$y'' = \sum_{n=0}^{\infty} (r+n)(r+n-1) a_n x^{r+n-2}.$$

Substitution into the ODE results in

$$\begin{aligned} 2 \sum_{n=0}^{\infty} (r+n)(r+n-1) a_n x^{r+n-1} + \sum_{n=0}^{\infty} (r+n) a_n x^{r+n-1} + \\ + \sum_{n=0}^{\infty} a_n x^{r+n+1} = 0. \end{aligned}$$

That is,

$$2 \sum_{n=0}^{\infty} (r+n)(r+n-1) a_n x^{r+n} + \sum_{n=0}^{\infty} (r+n) a_n x^{r+n} + \sum_{n=2}^{\infty} a_{n-2} x^{r+n} = 0.$$

It follows that

$$\begin{aligned} a_0 [2r(r-1) + r] x^r + a_1 [2(r+1)r + r + 1] x^{r+1} + \\ + \sum_{n=2}^{\infty} [2(r+n)(r+n-1) a_n + (r+n) a_n + a_{n-2}] x^{r+n} = 0. \end{aligned}$$

Assuming that  $a_0 \neq 0$ , we obtain the *indicial equation*  $2r^2 - r = 0$ , with roots  $r_1 = 1/2$

and  $r_2 = 0$ . It immediately follows that  $a_1 = 0$ . Setting the remaining coefficients equal to *zero*, we have

$$a_n = \frac{-a_{n-2}}{(r+n)[2(r+n)-1]}, \quad n = 2, 3, \dots$$

For  $r = 1/2$ , the recurrence relation becomes

$$a_n = \frac{-a_{n-2}}{n(1+2n)}, \quad n = 2, 3, \dots$$

Since  $a_1 = 0$ , the *odd* coefficients are *zero*. Furthermore, for  $k = 1, 2, \dots$ ,

$$a_{2k} = \frac{-a_{2k-2}}{2k(1+4k)} = \frac{a_{2k-4}}{(2k-2)(2k)(4k-3)(4k+1)} = \frac{(-1)^k a_0}{2^k k! 5 \cdot 9 \cdot 13 \cdots (4k+1)}.$$

For  $r = 0$ , the recurrence relation becomes

$$a_n = \frac{-a_{n-2}}{n(2n-1)}, \quad n = 2, 3, \dots$$

Since  $a_1 = 0$ , the *odd* coefficients are *zero*, and for  $k = 1, 2, \dots$ ,

$$a_{2k} = \frac{-a_{2k-2}}{2k(4k-1)} = \frac{a_{2k-4}}{(2k-2)(2k)(4k-5)(4k-1)} = \frac{(-1)^k a_0}{2^k k! 3 \cdot 7 \cdot 11 \cdots (4k-1)}.$$

The two linearly independent solutions are

$$y_1(x) = \sqrt{x} \left[ 1 + \sum_{k=1}^{\infty} \frac{(-1)^k x^{2k}}{2^k k! 5 \cdot 9 \cdot 13 \cdots (4k+1)} \right]$$

$$y_2(x) = 1 + \sum_{k=1}^{\infty} \frac{(-1)^k x^{2k}}{2^k k! 3 \cdot 7 \cdot 11 \cdots (4k-1)}.$$

3. Note that  $x p(x) = 0$  and  $x^2 q(x) = x$ , which are *both* analytic at  $x = 0$ . Set  $y = x^r(a_0 + a_1 x + a_2 x^2 + \cdots + a_n x^n + \cdots)$ . Substitution into the ODE results in

$$\sum_{n=0}^{\infty} (r+n)(r+n-1)a_n x^{r+n-1} + \sum_{n=0}^{\infty} a_n x^{r+n} = 0,$$

and after multiplying both sides of the equation by  $x$ ,

$$\sum_{n=0}^{\infty} (r+n)(r+n-1)a_n x^{r+n} + \sum_{n=1}^{\infty} a_{n-1} x^{r+n} = 0.$$

It follows that

$$a_0[r(r-1)]x^r + \sum_{n=1}^{\infty} [(r+n)(r+n-1)a_n + a_{n-1}]x^{r+n} = 0.$$

Setting the coefficients equal to *zero*, the *indicial equation* is  $r(r-1) = 0$ . The roots are  $r_1 = 1$  and  $r_2 = 0$ . Here  $r_1 - r_2 = 1$ . The recurrence relation is

$$a_n = \frac{-a_{n-1}}{(r+n)(r+n-1)}, \quad n = 1, 2, \dots.$$

For  $r = 1$ ,

$$a_n = \frac{-a_{n-1}}{n(n+1)}, \quad n = 1, 2, \dots.$$

Hence for  $n \geq 1$ ,

$$a_n = \frac{-a_{n-1}}{n(n+1)} = \frac{a_{n-2}}{(n-1)n^2(n+1)} = \dots = \frac{(-1)^n a_0}{n!(n+1)!}.$$

Therefore one solution is

$$y_1(x) = x \sum_{n=0}^{\infty} \frac{(-1)^n x^n}{n!(n+1)!}.$$

5. Here  $x p(x) = 2/3$  and  $x^2 q(x) = x^2/3$ , which are *both* analytic at  $x = 0$ . Set  $y = x^r(a_0 + a_1x + a_2x^2 + \dots + a_nx^n + \dots)$ . Substitution into the ODE results in

$$3 \sum_{n=0}^{\infty} (r+n)(r+n-1)a_n x^{r+n} + 2 \sum_{n=0}^{\infty} (r+n)a_n x^{r+n} + \sum_{n=0}^{\infty} a_n x^{r+n+2} = 0.$$

It follows that

$$\begin{aligned} & a_0[3r(r-1) + 2r]x^r + a_1[3(r+1)r + 2(r+1)]x^{r+1} + \\ & + \sum_{n=2}^{\infty} [3(r+n)(r+n-1)a_n + 2(r+n)a_n + a_{n-2}]x^{r+n} = 0. \end{aligned}$$

Assuming  $a_0 \neq 0$ , the *indicial equation* is  $3r^2 - r = 0$ , with roots  $r_1 = 1/3$ ,  $r_2 = 0$ . Setting the remaining coefficients equal to *zero*, we have  $a_1 = 0$ , and

$$a_n = \frac{-a_{n-2}}{(r+n)[3(r+n)-1]}, \quad n = 2, 3, \dots.$$

It immediately follows that the *odd* coefficients are equal to *zero*. For  $r = 1/3$ ,

$$a_n = \frac{-a_{n-2}}{n(1+3n)}, \quad n = 2, 3, \dots.$$

So for  $k = 1, 2, \dots$ ,

$$a_{2k} = \frac{-a_{2k-2}}{2k(6k+1)} = \frac{a_{2k-4}}{(2k-2)(2k)(6k-5)(6k+1)} = \frac{(-1)^k a_0}{2^k k! 7 \cdot 13 \cdots (6k+1)}.$$

For  $r = 0$ ,

$$a_n = \frac{-a_{n-2}}{n(3n-1)}, \quad n = 2, 3, \dots.$$

So for  $k = 1, 2, \dots$ ,

$$a_{2k} = \frac{-a_{2k-2}}{2k(6k-1)} = \frac{a_{2k-4}}{(2k-2)(2k)(6k-7)(6k-1)} = \frac{(-1)^k a_0}{2^k k! 5 \cdot 11 \cdots (6k-1)}.$$

The two linearly independent solutions are

$$y_1(x) = x^{1/3} \left[ 1 + \sum_{k=1}^{\infty} \frac{(-1)^k}{k! 7 \cdot 13 \cdots (6k+1)} \left(\frac{x^2}{2}\right)^k \right]$$

$$y_2(x) = 1 + \sum_{k=1}^{\infty} \frac{(-1)^k}{k! 5 \cdot 11 \cdots (6k-1)} \left(\frac{x^2}{2}\right)^k.$$

6. Note that  $x p(x) = 1$  and  $x^2 q(x) = x - 2$ , which are *both* analytic at  $x = 0$ . Set  $y = x^r(a_0 + a_1 x + a_2 x^2 + \cdots + a_n x^n + \cdots)$ . Substitution into the ODE results in

$$\begin{aligned} \sum_{n=0}^{\infty} (r+n)(r+n-1)a_n x^{r+n} + \sum_{n=0}^{\infty} (r+n)a_n x^{r+n} + \\ + \sum_{n=0}^{\infty} a_n x^{r+n+1} - 2 \sum_{n=0}^{\infty} a_n x^{r+n} = 0. \end{aligned}$$

After adjusting the indices in the *second-to-last* series, we obtain

$$a_0[r(r-1) + r - 2]x^r + \sum_{n=1}^{\infty} [(r+n)(r+n-1)a_n + (r+n)a_n - 2a_n + a_{n-1}]x^{r+n} = 0.$$

Assuming  $a_0 \neq 0$ , the *indicial equation* is  $r^2 - 2 = 0$ , with roots  $r = \pm \sqrt{2}$ . Setting the remaining coefficients equal to *zero*, the recurrence relation is

$$a_n = \frac{-a_{n-1}}{(r+n)^2 - 2}, \quad n = 1, 2, \dots.$$

First note that  $(r+n)^2 - 2 = (r+n+\sqrt{2})(r+n-\sqrt{2})$ . So for  $r = \sqrt{2}$ ,

$$a_n = \frac{-a_{n-1}}{n(n+2\sqrt{2})}, \quad n = 1, 2, \dots.$$

It follows that

$$a_n = \frac{(-1)^n a_0}{n! (1 + 2\sqrt{2})(2 + 2\sqrt{2}) \cdots (n + 2\sqrt{2})}, \quad n = 1, 2, \dots$$

For  $r = -\sqrt{2}$ ,

$$a_n = \frac{-a_{n-1}}{n(n - 2\sqrt{2})}, \quad n = 1, 2, \dots,$$

and therefore

$$a_n = \frac{(-1)^n a_0}{n! (1 - 2\sqrt{2})(2 - 2\sqrt{2}) \cdots (n - 2\sqrt{2})}, \quad n = 1, 2, \dots$$

The two linearly independent solutions are

$$y_1(x) = x^{\sqrt{2}} \left[ 1 + \sum_{n=1}^{\infty} \frac{(-1)^n x^n}{n! (1 + 2\sqrt{2})(2 + 2\sqrt{2}) \cdots (n + 2\sqrt{2})} \right]$$

$$y_2(x) = x^{-\sqrt{2}} \left[ 1 + \sum_{n=1}^{\infty} \frac{(-1)^n x^n}{n! (1 - 2\sqrt{2})(2 - 2\sqrt{2}) \cdots (n - 2\sqrt{2})} \right].$$

7. Here  $x p(x) = 1 - x$  and  $x^2 q(x) = -x$ , which are *both* analytic at  $x = 0$ . Set  $y = x^r (a_0 + a_1 x + a_2 x^2 + \cdots + a_n x^n + \cdots)$ . Substitution into the ODE results in

$$\begin{aligned} \sum_{n=0}^{\infty} (r+n)(r+n-1)a_n x^{r+n-1} + \sum_{n=0}^{\infty} (r+n)a_n x^{r+n-1} - \\ - \sum_{n=0}^{\infty} (r+n)a_n x^{r+n} - \sum_{n=0}^{\infty} a_n x^{r+n} = 0. \end{aligned}$$

After multiplying both sides by  $x$ ,

$$\begin{aligned} \sum_{n=0}^{\infty} (r+n)(r+n-1)a_n x^{r+n} + \sum_{n=0}^{\infty} (r+n)a_n x^{r+n} - \\ - \sum_{n=0}^{\infty} (r+n)a_n x^{r+n+1} - \sum_{n=0}^{\infty} a_n x^{r+n+1} = 0. \end{aligned}$$

After adjusting the indices in the *last two* series, we obtain

$$a_0[r(r-1) + r]x^r + \sum_{n=1}^{\infty} [(r+n)(r+n-1)a_n + (r+n)a_n - (r+n)a_{n-1}]x^{r+n} = 0.$$

Assuming  $a_0 \neq 0$ , the *indicial equation* is  $r^2 = 0$ , with roots  $r_1 = r_2 = 0$ . Setting the remaining coefficients equal to *zero*, the recurrence relation is

$$a_n = \frac{a_{n-1}}{r+n}, \quad n = 1, 2, \dots.$$

With  $r = 0$ ,

$$a_n = \frac{a_{n-1}}{n}, \quad n = 1, 2, \dots.$$

Hence one solution is

$$y_1(x) = 1 + \frac{x}{1!} + \frac{x^2}{2!} + \dots + \frac{x^n}{n!} + \dots = e^x.$$

8. Note that  $x p(x) = 3/2$  and  $x^2 q(x) = x^2 - 1/2$ , which are *both* analytic at  $x = 0$ . Set  $y = x^r(a_0 + a_1x + a_2x^2 + \dots + a_nx^n + \dots)$ . Substitution into the ODE results in

$$\begin{aligned} 2 \sum_{n=0}^{\infty} (r+n)(r+n-1)a_n x^{r+n} + 3 \sum_{n=0}^{\infty} (r+n)a_n x^{r+n} + \\ + 2 \sum_{n=0}^{\infty} a_n x^{r+n+2} - \sum_{n=0}^{\infty} a_n x^{r+n} = 0. \end{aligned}$$

After adjusting the indices in the *second-to-last* series, we obtain

$$\begin{aligned} a_0[2r(r-1) + 3r - 1]x^r + a_1[2(r+1)r + 3(r+1) - 1] + \\ + \sum_{n=2}^{\infty} [2(r+n)(r+n-1)a_n + 3(r+n)a_n - a_n + 2a_{n-2}]x^{r+n} = 0. \end{aligned}$$

Assuming  $a_0 \neq 0$ , the *indicial equation* is  $2r^2 + r - 1 = 0$ , with roots  $r_1 = 1/2$  and  $r_2 = -1$ . Setting the remaining coefficients equal to *zero*, the recurrence relation is

$$a_n = \frac{-2a_{n-2}}{(r+n+1)[2(r+n) - 1]}, \quad n = 2, 3, \dots.$$

Setting the remaining coefficients equal to *zero*, we have  $a_1 = 0$ , which implies that all of the *odd* coefficients are *zero*. With  $r = 1/2$ ,

$$a_n = \frac{-2a_{n-2}}{n(2n+3)}, \quad n = 2, 3, \dots.$$

So for  $k = 1, 2, \dots$ ,

$$a_{2k} = \frac{-a_{2k-2}}{k(4k+3)} = \frac{a_{2k-4}}{(k-1)k(4k-5)(4k+3)} = \frac{(-1)^k a_0}{k! 7 \cdot 11 \cdots (4k+3)}.$$

With  $r = -1$ ,

$$a_n = \frac{-2a_{n-2}}{n(2n-3)}, \quad n = 2, 3, \dots.$$

So for  $k = 1, 2, \dots$ ,

$$a_{2k} = \frac{-a_{2k-2}}{k(4k-3)} = \frac{a_{2k-4}}{(k-1)k(4k-11)(4k-3)} = \frac{(-1)^k a_0}{k! 5 \cdot 9 \cdots (4k-3)}.$$

The two linearly independent solutions are

$$y_1(x) = x^{1/2} \left[ 1 + \sum_{n=1}^{\infty} \frac{(-1)^n x^{2n}}{n! 7 \cdot 11 \cdots (4n+3)} \right]$$

$$y_2(x) = x^{-1} \left[ 1 + \sum_{n=1}^{\infty} \frac{(-1)^n x^{2n}}{n! 5 \cdot 9 \cdots (4n-3)} \right].$$

9. Note that  $x p(x) = -x - 3$  and  $x^2 q(x) = x + 3$ , which are *both* analytic at  $x = 0$ . Set  $y = x^r(a_0 + a_1 x + a_2 x^2 + \cdots + a_n x^n + \cdots)$ . Substitution into the ODE results in

$$\begin{aligned} \sum_{n=0}^{\infty} (r+n)(r+n-1)a_n x^{r+n} - \sum_{n=0}^{\infty} (r+n)a_n x^{r+n+1} - 3 \sum_{n=0}^{\infty} (r+n)a_n x^{r+n} \\ + \sum_{n=0}^{\infty} a_n x^{r+n+1} + 3 \sum_{n=0}^{\infty} a_n x^{r+n} = 0. \end{aligned}$$

After adjusting the indices in the *second-to-last* series, we obtain

$$\begin{aligned} a_0[r(r-1) - 3r + 3]x^r + \\ + \sum_{n=1}^{\infty} [(r+n)(r+n-1)a_n - (r+n-2)a_{n-1} - 3(r+n-1)a_n]x^{r+n} = 0. \end{aligned}$$

Assuming  $a_0 \neq 0$ , the *indicial equation* is  $r^2 - 4r + 3 = 0$ , with roots  $r_1 = 3$  and  $r_2 = 1$ . Setting the remaining coefficients equal to *zero*, the recurrence relation is

$$a_n = \frac{(r+n-2)a_{n-1}}{(r+n-1)(r+n-3)}, \quad n = 1, 2, \dots.$$

With  $r = 3$ ,



$$a_n = \frac{(n+1)a_{n-1}}{n(n+2)}, \quad n = 1, 2, \dots.$$

It follows that for  $n \geq 1$ ,

$$a_n = \frac{(n+1)a_{n-1}}{n(n+2)} = \frac{a_{n-2}}{(n-1)(n+2)} = \dots = \frac{2a_0}{n!(n+2)}.$$

Therefore one solution is

$$y_1(x) = x^3 \left[ 1 + \sum_{n=1}^{\infty} \frac{2x^n}{n!(n+2)} \right].$$

10. Here  $x p(x) = 0$  and  $x^2 q(x) = x^2 + 1/4$ , which are *both* analytic at  $x = 0$ . Set  $y = x^r(a_0 + a_1x + a_2x^2 + \dots + a_nx^n + \dots)$ . Substitution into the ODE results in

$$\sum_{n=0}^{\infty} (r+n)(r+n-1)a_n x^{r+n} + \sum_{n=0}^{\infty} a_n x^{r+n+2} + \frac{1}{4} \sum_{n=0}^{\infty} a_n x^{r+n} = 0.$$

After adjusting the indices in the *second* series, we obtain

$$\begin{aligned} a_0 \left[ r(r-1) + \frac{1}{4} \right] x^r + a_1 \left[ (r+1)r + \frac{1}{4} \right] x^{r+1} + \\ + \sum_{n=2}^{\infty} \left[ (r+n)(r+n-1)a_n + \frac{1}{4}a_n + a_{n-2} \right] x^{r+n} = 0. \end{aligned}$$

Assuming  $a_0 \neq 0$ , the *indicial equation* is  $r^2 - r + \frac{1}{4} = 0$ , with roots  $r_1 = r_2 = 1/2$ . Setting the remaining coefficients equal to *zero*, we find that  $a_1 = 0$ . The recurrence relation is

$$a_n = \frac{-4a_{n-2}}{(2r+2n-1)^2}, \quad n = 2, 3, \dots.$$

With  $r = 1/2$ ,

$$a_n = \frac{-a_{n-2}}{n^2}, \quad n = 2, 3, \dots.$$

Since  $a_1 = 0$ , the *odd* coefficients are *zero*. So for  $k \geq 1$ ,

$$a_{2k} = \frac{-a_{2k-2}}{4k^2} = \frac{a_{2k-4}}{4^2(k-1)^2k^2} = \dots = \frac{(-1)^k a_0}{4^k (k!)^2}.$$

Therefore one solution is

$$y_1(x) = \sqrt{x} \left[ 1 + \sum_{n=1}^{\infty} \frac{(-1)^n x^{2n}}{2^{2n} (n!)^2} \right].$$

12(a). Dividing through by the leading coefficient, the ODE can be written as

$$y'' - \frac{x}{1-x^2} y' + \frac{\alpha^2}{1-x^2} y = 0.$$

For  $x = 1$ ,

$$p_0 = \lim_{x \rightarrow 1} (x-1)p(x) = \lim_{x \rightarrow 1} \frac{x}{x+1} = \frac{1}{2}.$$

$$q_0 = \lim_{x \rightarrow 1} (x-1)^2 q(x) = \lim_{x \rightarrow 1} \frac{\alpha^2(1-x)}{x+1} = 0.$$

For  $x = -1$ ,

$$p_0 = \lim_{x \rightarrow -1} (x+1)p(x) = \lim_{x \rightarrow -1} \frac{x}{x-1} = \frac{1}{2}.$$

$$q_0 = \lim_{x \rightarrow -1} (x+1)^2 q(x) = \lim_{x \rightarrow -1} \frac{\alpha^2(x+1)}{(1-x)} = 0.$$

Hence both  $x = -1$  and  $x = 1$  are *regular* singular points. As shown in Example 1, the indicial equation is given by

$$r(r-1) + p_0 r + q_0 = 0.$$

In this case, *both* sets of roots are  $r_1 = 1/2$  and  $r_2 = 0$ .

(b). Let  $t = x - 1$ , and  $u(t) = y(t + 1)$ . Under this change of variable, the differential equation becomes

$$(t^2 + 2t)u'' + (t+1)u' - \alpha^2 u = 0.$$

Based on Part (a),  $t = 0$  is a *regular* singular point. Set  $u = \sum_{n=0}^{\infty} a_n t^{r+n}$ . Substitution into the ODE results in

$$\begin{aligned} & \sum_{n=0}^{\infty} (r+n)(r+n-1)a_n t^{r+n} + 2 \sum_{n=0}^{\infty} (r+n)(r+n-1)a_n t^{r+n-1} + \\ & + \sum_{n=0}^{\infty} (r+n)a_n t^{r+n} + \sum_{n=0}^{\infty} (r+n)a_n t^{r+n-1} - \alpha^2 \sum_{n=0}^{\infty} a_n t^{r+n} = 0. \end{aligned}$$

Upon inspection, we can also write

$$\sum_{n=0}^{\infty} (r+n)^2 a_n t^{r+n} + 2 \sum_{n=0}^{\infty} (r+n) \left(r+n-\frac{1}{2}\right) a_n t^{r+n-1} - \alpha^2 \sum_{n=0}^{\infty} a_n t^{r+n} = 0.$$

After adjusting the indices in the *second* series, it follows that

$$a_0 \left[2r \left(r-\frac{1}{2}\right)\right] t^{r-1} + \sum_{n=0}^{\infty} \left[(r+n)^2 a_n + 2(r+n+1) \left(r+n+\frac{1}{2}\right) a_{n+1} - \alpha^2 a_n\right] t^{r+n} = 0.$$

Assuming that  $a_0 \neq 0$ , the *indicial equation* is  $2r^2 - r = 0$ , with roots  $r = 0, 1/2$ . The recurrence relation is

$$(r+n)^2 a_n + 2(r+n+1) \left(r+n+\frac{1}{2}\right) a_{n+1} - \alpha^2 a_n = 0, \quad n = 0, 1, 2, \dots$$

With  $r_1 = 1/2$ , we find that for  $n \geq 1$ ,

$$\begin{aligned} a_n &= \frac{4\alpha^2 - (2n-1)^2}{4n(2n+1)} a_{n-1} \\ &= (-1)^n \frac{[1-4\alpha^2][9-4\alpha^2] \cdots [(2n-1)^2-4\alpha^2]}{2^n(2n+1)!} a_0. \end{aligned}$$

With  $r_2 = 0$ , we find that for  $n \geq 1$ ,

$$\begin{aligned} a_n &= \frac{\alpha^2 - (n-1)^2}{n(2n-1)} a_{n-1} \\ &= (-1)^n \frac{\alpha(-\alpha)[1-\alpha^2][4-\alpha^2] \cdots [(n-1)^2-\alpha^2]}{n! \cdot 3 \cdot 5 \cdots (2n-1)} a_0. \end{aligned}$$

The two linearly independent solutions of the *Chebyshev equation* are

$$y_1(x) = |x-1|^{1/2} \left[ 1 + \sum_{n=1}^{\infty} (-1)^n \frac{[1-4\alpha^2][9-4\alpha^2] \cdots [(2n-1)^2-4\alpha^2]}{2^n(2n+1)!} (x-1)^n \right]$$

$$y_2(x) = 1 + \sum_{n=1}^{\infty} (-1)^n \frac{\alpha(-\alpha)[1-\alpha^2][4-\alpha^2] \cdots [(n-1)^2-\alpha^2]}{n! \cdot 3 \cdot 5 \cdots (2n-1)} (x-1)^n.$$

13. Here  $x p(x) = 1 - x$  and  $x^2 q(x) = \lambda x$ , which are *both* analytic at  $x = 0$ . In fact,

$$p_0 = \lim_{x \rightarrow 0} x p(x) = 1 \quad \text{and} \quad q_0 = \lim_{x \rightarrow 0} x^2 q(x) = 0.$$

Hence the *indicial equation* is  $r(r-1) + r = 0$ , with roots  $r_{1,2} = 0$ . Set

$$y = a_0 + a_1x + a_2x^2 + \cdots + a_nx^n + \cdots.$$

Substitution into the ODE results in

$$\begin{aligned} \sum_{n=2}^{\infty} n(n-1)a_n x^{n-1} + \sum_{n=1}^{\infty} na_n x^{n-1} - \\ - \sum_{n=0}^{\infty} na_n x^n + \lambda \sum_{n=0}^{\infty} a_n x^n = 0. \end{aligned}$$

That is,

$$\begin{aligned} \sum_{n=1}^{\infty} n(n+1)a_{n+1} x^n + \sum_{n=0}^{\infty} (n+1)a_{n+1} x^n - \\ - \sum_{n=1}^{\infty} na_n x^n + \lambda \sum_{n=0}^{\infty} a_n x^n = 0. \end{aligned}$$

It follows that

$$a_1 + \lambda a_0 + \sum_{n=1}^{\infty} [(n+1)^2 a_{n+1} - (n-\lambda)a_n] x^n = 0.$$

Setting the coefficients equal to *zero*, we find that  $a_1 = -\lambda a_0$ , and

$$a_n = \frac{(n-1-\lambda)}{n^2} a_{n-1}, \quad n = 2, 3, \dots.$$

That is, for  $n \geq 2$ ,

$$a_n = \frac{(n-1-\lambda)}{n^2} a_{n-1} = \cdots = \frac{(-\lambda)(1-\lambda)\cdots(n-1-\lambda)}{(n!)^2} a_0.$$

Therefore one solution of the *Laguerre equation* is

$$y_1(x) = 1 + \sum_{n=1}^{\infty} \frac{(-\lambda)(1-\lambda)\cdots(n-1-\lambda)}{(n!)^2} x^n.$$

Note that if  $\lambda = m$ , a *positive integer*, then  $a_n = 0$  for  $n \geq m+1$ . In that case, the solution is a *polynomial*

$$y_1(x) = 1 + \sum_{n=1}^m \frac{(-\lambda)(1-\lambda)\cdots(n-1-\lambda)}{(n!)^2} x^n.$$

## Section 5.7

2.  $P(x) = 0$  only for  $x = 0$ . Furthermore,  $x p(x) = -2 - x$  and  $x^2 q(x) = 2 + x^2$ . It follows that

$$p_0 = \lim_{x \rightarrow 0} (-2 - x) = -2$$

$$q_0 = \lim_{x \rightarrow 0} (2 + x^2) = 2$$

and therefore  $x = 0$  is a *regular* singular point. The indicial equation is given by

$$r(r - 1) - 2r + 2 = 0,$$

that is,  $r^2 - 3r + 2 = 0$ , with roots  $r_1 = 2$  and  $r_2 = 1$ .

4. The coefficients  $P(x)$ ,  $Q(x)$ , and  $R(x)$  are analytic for all  $x \in \mathbb{R}$ . Hence there are *no* singular points.

5.  $P(x) = 0$  only for  $x = 0$ . Furthermore,  $x p(x) = 3 \frac{\sin x}{x}$  and  $x^2 q(x) = -2$ . It follows that

$$p_0 = \lim_{x \rightarrow 0} 3 \frac{\sin x}{x} = 3$$

$$q_0 = \lim_{x \rightarrow 0} -2 = -2$$

and therefore  $x = 0$  is a *regular* singular point. The indicial equation is given by

$$r(r - 1) + 3r - 2 = 0,$$

that is,  $r^2 + 2r - 2 = 0$ , with roots  $r_1 = -1 + \sqrt{3}$  and  $r_2 = -1 - \sqrt{3}$ .

6.  $P(x) = 0$  for  $x = 0$  and  $x = -2$ . We note that  $p(x) = x^{-1}(x + 2)^{-1}/2$ , and  $q(x) = -(x + 2)^{-1}/2$ . For the singularity at  $x = 0$ ,

$$p_0 = \lim_{x \rightarrow 0} \frac{1}{2(x + 2)} = \frac{1}{4}$$

$$q_0 = \lim_{x \rightarrow 0} \frac{-x^2}{2(x + 2)} = 0$$

and therefore  $x = 0$  is a *regular* singular point. The indicial equation is given by

$$r(r - 1) + \frac{1}{4}r = 0,$$

that is,  $r^2 - \frac{3}{4}r = 0$ , with roots  $r_1 = \frac{3}{4}$  and  $r_2 = 0$ . For the singularity at  $x = -2$ ,

$$p_0 = \lim_{x \rightarrow -2} (x+2)p(x) = \lim_{x \rightarrow -2} \frac{1}{2x} = -\frac{1}{4}$$

$$q_0 = \lim_{x \rightarrow -2} (x+2)^2 q(x) = \lim_{x \rightarrow -2} \frac{-(x+2)}{2} = 0$$

and therefore  $x = -2$  is a *regular* singular point. The indicial equation is given by

$$r(r-1) - \frac{1}{4}r = 0,$$

that is,  $r^2 - \frac{5}{4}r = 0$ , with roots  $r_1 = \frac{5}{4}$  and  $r_2 = 0$ .

7.  $P(x) = 0$  only for  $x = 0$ . Furthermore,  $x p(x) = \frac{1}{2} + \frac{\sin x}{2x}$  and  $x^2 q(x) = 1$ . It follows that

$$p_0 = \lim_{x \rightarrow 0} x p(x) = 1$$

$$q_0 = \lim_{x \rightarrow 0} x^2 q(x) = 1$$

and therefore  $x = 0$  is a *regular* singular point. The indicial equation is given by

$$r(r-1) + r + 1 = 0,$$

that is,  $r^2 + 1 = 0$ , with *complex conjugate* roots  $r = \pm i$ .

8. Note that  $P(x) = 0$  only for  $x = -1$ . We find that  $p(x) = 3(x-1)/(x+1)$ , and  $q(x) = 3/(x+1)^2$ . It follows that

$$p_0 = \lim_{x \rightarrow -1} (x+1)p(x) = \lim_{x \rightarrow -1} 3(x-1) = -6$$

$$q_0 = \lim_{x \rightarrow -1} (x+1)^2 q(x) = \lim_{x \rightarrow -1} 3 = 3$$

and therefore  $x = -1$  is a *regular* singular point. The indicial equation is given by

$$r(r-1) - 6r + 3 = 0,$$

that is,  $r^2 - 7r + 3 = 0$ , with roots  $r_1 = (7 + \sqrt{37})/2$  and  $r_2 = (7 - \sqrt{37})/2$ .

10.  $P(x) = 0$  for  $x = 2$  and  $x = -2$ . We note that  $p(x) = 2x(x-2)^{-2}(x+2)^{-1}$ , and  $q(x) = 3(x-2)^{-1}(x+2)^{-1}$ . For the singularity at  $x = 2$ ,

$$\lim_{x \rightarrow 2} (x-2)p(x) = \lim_{x \rightarrow 2} \frac{2x}{x^2 - 4},$$

which is *undefined*. Therefore  $x = 0$  is an *irregular* singular point. For the singularity at  $x = -2$ ,

$$p_0 = \lim_{x \rightarrow -2} (x+2)p(x) = \lim_{x \rightarrow -2} \frac{2x}{(x-2)^2} = -\frac{1}{4}$$

$$q_0 = \lim_{x \rightarrow -2} (x+2)^2 q(x) = \lim_{x \rightarrow -2} \frac{3(x+2)}{x-2} = 0$$

and therefore  $x = -2$  is a *regular* singular point. The indicial equation is given by

$$r(r-1) - \frac{1}{4}r = 0,$$

that is,  $r^2 - \frac{5}{4}r = 0$ , with roots  $r_1 = \frac{5}{4}$  and  $r_2 = 0$ .

11.  $P(x) = 0$  for  $x = 2$  and  $x = -2$ . We note that  $p(x) = 2x/(4-x^2)$ , and  $q(x) = 3/(4-x^2)$ . For the singularity at  $x = 2$ ,

$$p_0 = \lim_{x \rightarrow 2} (x-2)p(x) = \lim_{x \rightarrow 2} \frac{-2x}{x+2} = -1$$

$$q_0 = \lim_{x \rightarrow 2} (x-2)^2 q(x) = \lim_{x \rightarrow 2} \frac{3(2-x)}{x+2} = 0$$

and therefore  $x = 2$  is a *regular* singular point. The indicial equation is given by

$$r(r-1) - r = 0,$$

that is,  $r^2 - 2r = 0$ , with roots  $r_1 = 2$  and  $r_2 = 0$ . For the singularity at  $x = -2$ ,

$$p_0 = \lim_{x \rightarrow -2} (x+2)p(x) = \lim_{x \rightarrow -2} \frac{2x}{2-x} = -1$$

$$q_0 = \lim_{x \rightarrow -2} (x+2)^2 q(x) = \lim_{x \rightarrow -2} \frac{3(x+2)}{2-x} = 0$$

and therefore  $x = -2$  is a *regular* singular point. The indicial equation is given by

$$r(r-1) - r = 0,$$

that is,  $r^2 - 2r = 0$ , with roots  $r_1 = 2$  and  $r_2 = 0$ .

12.  $P(x) = 0$  for  $x = 0$  and  $x = -3$ . We note that  $p(x) = -2x^{-1}(x+3)^{-1}$ , and  $q(x) = -1/(x+3)^2$ . For the singularity at  $x = 0$ ,

$$p_0 = \lim_{x \rightarrow 0} x p(x) = \lim_{x \rightarrow 0} \frac{-2}{x+3} = -\frac{2}{3}$$

$$q_0 = \lim_{x \rightarrow 0} x^2 q(x) = \lim_{x \rightarrow 0} \frac{-x^2}{(x+3)^2} = 0$$

and therefore  $x = 0$  is a *regular* singular point. The indicial equation is given by

$$r(r-1) - \frac{2}{3}r = 0,$$

that is,  $r^2 - \frac{5}{3}r = 0$ , with roots  $r_1 = \frac{5}{3}$  and  $r_2 = 0$ . For the singularity at  $x = -3$ ,

$$p_0 = \lim_{x \rightarrow -3} (x+3)p(x) = \lim_{x \rightarrow -3} \frac{-2}{x} = \frac{2}{3}$$

$$q_0 = \lim_{x \rightarrow -3} (x+3)^2 q(x) = \lim_{x \rightarrow -3} (-1) = -1$$

and therefore  $x = -3$  is a *regular* singular point. The indicial equation is given by

$$r(r-1) + \frac{2}{3}r - 1 = 0,$$

that is,  $r^2 - \frac{1}{3}r - 1 = 0$ , with roots  $r_1 = (1 + \sqrt{37})/6$  and  $r_2 = (1 - \sqrt{37})/6$ .

13(a). Note the  $p(x) = 1/x$  and  $q(x) = -1/x$ . Furthermore,  $x p(x) = 1$  and  $x^2 q(x) = -x$ . It follows that

$$p_0 = \lim_{x \rightarrow 0} (1) = 1$$

$$q_0 = \lim_{x \rightarrow 0} (-x) = 0$$

and therefore  $x = 0$  is a *regular* singular point.

(b). The indicial equation is given by

$$r(r-1) + r = 0,$$

that is,  $r^2 = 0$ , with roots  $r_1 = r_2 = 0$ .

(c). Let  $y = a_0 + a_1x + a_2x^2 + \cdots + a_nx^n + \cdots$ . Substitution into the ODE results in

$$\sum_{n=0}^{\infty} (n+2)(n+1)a_{n+2}x^{n+1} + \sum_{n=0}^{\infty} (n+1)a_{n+1}x^n - \sum_{n=0}^{\infty} a_nx^n = 0.$$

After adjusting the indices in the *first* series, we obtain

$$a_1 - a_0 + \sum_{n=1}^{\infty} [n(n+1)a_{n+1} + (n+1)a_{n+1} - a_n]x^n = 0.$$

Setting the coefficients equal to *zero*, it follows that for  $n \geq 0$ ,

$$a_{n+1} = \frac{a_n}{(n+1)^2}.$$

So for  $n \geq 1$ ,



$$a_n = \frac{a_{n-1}}{n^2} = \frac{a_{n-2}}{n^2(n-1)^2} = \cdots = \frac{1}{(n!)^2} a_0.$$

With  $a_0 = 1$ , one solution is

$$y_1(x) = 1 + x + \frac{1}{4}x^2 + \frac{1}{36}x^3 + \cdots + \frac{1}{(n!)^2}x^n + \cdots.$$

For a second solution, set  $y_2(x) = y_1(x) \ln x + b_1x + b_2x^2 + \cdots + b_nx^n + \cdots$ . Substituting into the ODE, we obtain

$$L[y_1(x)] \cdot \ln x + 2y_1'(x) + L\left[\sum_{n=1}^{\infty} b_n x^n\right] = 0.$$

Since  $L[y_1(x)] = 0$ , it follows that

$$L\left[\sum_{n=1}^{\infty} b_n x^n\right] = -2y_1'(x).$$

More specifically,

$$\begin{aligned} b_1 + \sum_{n=1}^{\infty} [n(n+1)b_{n+1} + (n+1)b_{n+1} - b_n]x^n &= \\ &= -2 - x - \frac{1}{6}x^2 - \frac{1}{72}x^3 - \frac{1}{1440}x^4 - \cdots. \end{aligned}$$

Equating the coefficients, we obtain the system of equations

$$\begin{aligned} b_1 &= -2 \\ 4b_2 - b_1 &= -1 \\ 9b_3 - b_2 &= -1/6 \\ 16b_4 - b_3 &= -1/72 \\ &\vdots \end{aligned}$$

Solving these equations for the coefficients,  $b_1 = -2$ ,  $b_2 = -3/4$ ,  $b_3 = -11/108$ ,  $b_4 = -25/3456$ ,  $\cdots$ . Therefore a *second* solution is

$$y_2(x) = y_1(x) \ln x + \left[ -2x - \frac{3}{4}x^2 - \frac{11}{108}x^3 - \frac{25}{3456}x^4 - \cdots \right].$$

14(a). Here  $x p(x) = 2x$  and  $x^2 q(x) = 6xe^x$ . Both of these functions are *analytic* at  $x = 0$ , therefore  $x = 0$  is a *regular* singular point. Note that  $p_0 = q_0 = 0$ .

(b). The indicial equation is given by

$$r(r - 1) = 0,$$

that is,  $r^2 - r = 0$ , with roots  $r_1 = 1$  and  $r_2 = 0$ .

(c). In order to find the solution corresponding to  $r_1 = 1$ , set  $y = x \sum_{n=0}^{\infty} a_n x^n$ . Upon substitution into the ODE, we have

$$\sum_{n=0}^{\infty} (n+2)(n+1)a_{n+1}x^{n+1} + 2 \sum_{n=0}^{\infty} (n+1)a_n x^{n+1} + 6e^x \sum_{n=0}^{\infty} a_n x^{n+1} = 0.$$

After adjusting the indices in the *first* two series, and expanding the *exponential* function,

$$\begin{aligned} & \sum_{n=1}^{\infty} n(n+1)a_n x^n + 2 \sum_{n=1}^{\infty} n a_{n-1} x^n + 6a_0 x + (6a_0 + 6a_1)x^2 + \\ & + (6a_2 + 6a_1 + 3a_0)x^3 + (6a_3 + 6a_2 + 3a_1 + a_0)x^4 + \dots = 0. \end{aligned}$$

Equating the coefficients, we obtain the system of equations

$$\begin{aligned} 2a_1 + 2a_0 + 6a_0 &= 0 \\ 6a_2 + 4a_1 + 6a_0 + 6a_1 &= 0 \\ 12a_3 + 6a_2 + 6a_2 + 6a_1 + 3a_0 &= 0 \\ 20a_4 + 8a_3 + 6a_3 + 6a_2 + 3a_1 + a_0 &= 0 \\ &\vdots \end{aligned}$$

Setting  $a_0 = 1$ , solution of the system results in  $a_1 = -4$ ,  $a_2 = 17/3$ ,  $a_3 = -47/12$ ,  $a_4 = 191/120$ ,  $\dots$ . Therefore one solution is

$$y_1(x) = x - 4x^2 + \frac{17}{3}x^3 - \frac{47}{12}x^4 + \dots$$

The exponents differ by an integer. So for a second solution, set

$$y_2(x) = a y_1(x) \ln x + 1 + c_1 x + c_2 x^2 + \dots + c_n x^n + \dots$$

Substituting into the ODE, we obtain

$$a L[y_1(x)] \cdot \ln x + 2a y_1'(x) + 2a y_1(x) - a \frac{y_1(x)}{x} + L \left[ 1 + \sum_{n=1}^{\infty} c_n x^n \right] = 0.$$

Since  $L[y_1(x)] = 0$ , it follows that

$$L \left[ 1 + \sum_{n=1}^{\infty} c_n x^n \right] = -2a y_1'(x) - 2a y_1(x) + a \frac{y_1(x)}{x}.$$

More specifically,

$$\begin{aligned} & \sum_{n=1}^{\infty} n(n+1)c_{n+1}x^n + 2\sum_{n=1}^{\infty} n c_n x^n + 6 + (6 + 6c_1)x + \\ & + (6c_2 + 6c_1 + 3)x^2 + \dots = -a + 10ax - \frac{61}{3}ax^2 + \frac{193}{12}ax^3 + \dots \end{aligned}$$

Equating the coefficients, we obtain the system of equations

$$\begin{aligned} 6 &= -a \\ 2c_2 + 8c_1 + 6 &= 10a \\ 6c_3 + 10c_2 + 6c_1 + 3 &= -\frac{61}{3}a \\ 12c_4 + 12c_3 + 6c_2 + 3c_1 + 1 &= \frac{193}{12}a \\ &\vdots \end{aligned}$$

Solving these equations for the coefficients,  $a = -6$ . In order to solve the remaining equations, set  $c_1 = 0$ . Then  $c_2 = -33$ ,  $c_3 = 449/6$ ,  $c_4 = -1595/24, \dots$ . Therefore a *second* solution is

$$y_2(x) = -6 y_1(x) \ln x + \left[ 1 - 33x^2 + \frac{449}{6}x^3 - \frac{1595}{24}x^4 + \dots \right].$$

15(a). Note the  $p(x) = 6x/(x-1)$  and  $q(x) = 3x^{-1}(x-1)^{-1}$ . Furthermore,  $x p(x) = 6x^2/(x-1)$  and  $x^2 q(x) = 3x/(x-1)$ . It follows that

$$\begin{aligned} p_0 &= \lim_{x \rightarrow 0} \frac{6x^2}{x-1} = 0 \\ q_0 &= \lim_{x \rightarrow 0} \frac{3x}{x-1} = 0 \end{aligned}$$

and therefore  $x = 0$  is a *regular* singular point.

(b). The indicial equation is given by

$$r(r-1) = 0,$$

that is,  $r^2 - r = 0$ , with roots  $r_1 = 1$  and  $r_2 = 0$ .

(c). In order to find the solution corresponding to  $r_1 = 1$ , set  $y = x \sum_{n=0}^{\infty} a_n x^n$ . Upon substitution into the ODE, we have

$$\begin{aligned} \sum_{n=1}^{\infty} n(n+1)a_n x^{n+1} - \sum_{n=1}^{\infty} n(n+1)a_n x^n + \\ + 6 \sum_{n=0}^{\infty} (n+1)a_n x^{n+2} + 3 \sum_{n=0}^{\infty} a_n x^{n+1} = 0. \end{aligned}$$

After adjusting the indices, it follows that

$$\begin{aligned} \sum_{n=2}^{\infty} n(n-1)a_{n-1} x^n - \sum_{n=1}^{\infty} n(n+1)a_n x^n + \\ + 6 \sum_{n=2}^{\infty} (n-1)a_{n-2} x^n + 3 \sum_{n=1}^{\infty} a_{n-1} x^n = 0. \end{aligned}$$

That is,

$$-2a_1 + 3a_0 + \sum_{n=2}^{\infty} [-n(n+1)a_n + (n^2 - n + 3)a_{n-1} + 6(n-1)a_{n-2}]x^n = 0.$$

Setting the coefficients equal to *zero*, we have  $a_1 = 3a_0/2$ , and for  $n \geq 2$ ,

$$n(n+1)a_n = (n^2 - n + 3)a_{n-1} + 6(n-1)a_{n-2}.$$

If we assign  $a_0 = 1$ , then we obtain  $a_1 = 3/2$ ,  $a_2 = 9/4$ ,  $a_3 = 51/16$ ,  $\dots$ .  
Hence one solution is

$$y_1(x) = x + \frac{3}{2}x^2 + \frac{9}{4}x^3 + \frac{51}{16}x^4 + \frac{111}{40}x^5 + \dots.$$

The exponents differ by an *integer*. So for a second solution, set

$$y_2(x) = a y_1(x) \ln x + 1 + c_1 x + c_2 x^2 + \dots + c_n x^n + \dots.$$

Substituting into the ODE, we obtain

$$2ax y_1'(x) - 2a y_1'(x) + 6ax y_1(x) - a y_1(x) + a \frac{y_1(x)}{x} + L \left[ 1 + \sum_{n=1}^{\infty} c_n x^n \right] = 0,$$

since  $L[y_1(x)] = 0$ . It follows that

$$L \left[ 1 + \sum_{n=1}^{\infty} c_n x^n \right] = 2a y_1'(x) - 2ax y_1'(x) + a y_1(x) - 6ax y_1(x) - a \frac{y_1(x)}{x}.$$

Now

$$\begin{aligned} L \left[ 1 + \sum_{n=1}^{\infty} c_n x^n \right] = 3 + (-2c_2 + 3c_1)x + (-6c_3 + 5c_2 + 6c_1)x^2 + \\ + (-12c_4 + 9c_3 + 12c_2)x^3 + (-20c_5 + 15c_4 + 18c_3)x^4 + \dots \end{aligned}$$

Substituting for  $y_1(x)$ , the *right hand side* of the ODE is

$$a + \frac{7}{2}ax + \frac{3}{4}ax^2 + \frac{33}{16}ax^3 - \frac{867}{80}ax^4 - \frac{441}{10}ax^5 + \dots$$

Equating the coefficients, we obtain the system of equations

$$\begin{aligned} 3 &= a \\ -2c_2 + 3c_1 &= \frac{7}{2}a \\ -6c_3 + 5c_2 + 6c_1 &= \frac{3}{4}a \\ -12c_4 + 9c_3 + 12c_2 &= \frac{33}{16}a \\ &\vdots \end{aligned}$$

We find that  $a = 3$ . In order to solve the second equation, set  $c_1 = 0$ . Solution of the remaining equations results in  $c_2 = -21/4$ ,  $c_3 = -19/4$ ,  $c_4 = -597/64$ ,  $\dots$ .

Hence a second solution is

$$y_2(x) = 3y_1(x) \ln x + \left[ 1 - \frac{21}{4}x^2 - \frac{19}{4}x^3 - \frac{597}{64}x^4 + \dots \right].$$

16(a). After multiplying both sides of the ODE by  $x$ , we find that  $x p(x) = 0$  and  $x^2 q(x) = x$ . Both of these functions are *analytic* at  $x = 0$ , hence  $x = 0$  is a *regular* singular point.

(b). Furthermore,  $p_0 = q_0 = 0$ . So the indicial equation is  $r(r - 1) = 0$ , with roots  $r_1 = 1$  and  $r_2 = 0$ .

(c). In order to find the solution corresponding to  $r_1 = 1$ , set  $y = x \sum_{n=0}^{\infty} a_n x^n$ . Upon substitution into the ODE, we have

$$\sum_{n=1}^{\infty} n(n+1)a_n x^n + \sum_{n=0}^{\infty} a_n x^{n+1} = 0.$$

That is,

$$\sum_{n=1}^{\infty} [n(n+1)a_n + a_{n-1}] x^n = 0.$$

Setting the coefficients equal to *zero*, we find that for  $n \geq 1$ ,

$$a_n = \frac{-a_{n-1}}{n(n+1)}.$$

It follows that

$$a_n = \frac{-a_{n-1}}{n(n+1)} = \frac{a_{n-2}}{(n-1)n^2(n+1)} = \dots = \frac{(-1)^n a_0}{(n!)^2(n+1)}.$$

Hence one solution is

$$y_1(x) = x - \frac{1}{2}x^2 + \frac{1}{12}x^3 - \frac{1}{144}x^4 + \frac{1}{2880}x^5 + \dots.$$

The exponents differ by an *integer*. So for a second solution, set

$$y_2(x) = a y_1(x) \ln x + 1 + c_1 x + c_2 x^2 + \dots + c_n x^n + \dots.$$

Substituting into the ODE, we obtain

$$a L[y_1(x)] \cdot \ln x + 2a y_1'(x) - a \frac{y_1(x)}{x} + L \left[ 1 + \sum_{n=1}^{\infty} c_n x^n \right] = 0.$$

Since  $L[y_1(x)] = 0$ , it follows that

$$L \left[ 1 + \sum_{n=1}^{\infty} c_n x^n \right] = -2a y_1'(x) + a \frac{y_1(x)}{x}.$$

Now

$$L \left[ 1 + \sum_{n=1}^{\infty} c_n x^n \right] = 1 + (2c_2 + c_1)x + (6c_3 + c_2)x^2 + (12c_4 + c_3)x^3 + (20c_5 + c_4)x^4 + (30c_6 + c_5)x^5 + \dots.$$

Substituting for  $y_1(x)$ , the *right hand side* of the ODE is

$$-a + \frac{3}{2}ax - \frac{5}{12}ax^2 + \frac{7}{144}ax^3 - \frac{1}{320}ax^4 + \dots.$$

Equating the coefficients, we obtain the system of equations

$$\begin{aligned} 1 &= -a \\ 2c_2 + c_1 &= \frac{3}{2}a \\ 6c_3 + c_2 &= -\frac{5}{12}a \\ 12c_4 + c_3 &= \frac{7}{144}a \\ &\vdots \end{aligned}$$

Evidently,  $a = -1$ . In order to solve the *second* equation, set  $c_1 = 0$ . We then find that  $c_2 = -3/4$ ,  $c_3 = 7/36$ ,  $c_4 = -35/1728$ ,  $\dots$ . Therefore a second solution is

$$y_2(x) = -y_1(x) \ln x + \left[ 1 - \frac{3}{4}x^2 + \frac{7}{36}x^3 - \frac{35}{1728}x^4 + \dots \right].$$

19(a). After dividing by the leading coefficient, we find that

$$p_0 = \lim_{x \rightarrow 0} x p(x) = \lim_{x \rightarrow 0} \frac{\gamma - (1 + \alpha + \beta)x}{1 - x} = \gamma.$$

$$q_0 = \lim_{x \rightarrow 0} x^2 q(x) = \lim_{x \rightarrow 0} \frac{-\alpha\beta x}{1 - x} = 0.$$

Hence  $x = 0$  is a *regular* singular point. The indicial equation is  $r(r - 1) + \gamma r = 0$ , with roots  $r_1 = 1 - \gamma$  and  $r_2 = 0$ .

(b). For  $x = 1$ ,

$$p_0 = \lim_{x \rightarrow 1} (x - 1)p(x) = \lim_{x \rightarrow 1} \frac{-\gamma + (1 + \alpha + \beta)x}{x} = 1 - \gamma + \alpha + \beta.$$

$$q_0 = \lim_{x \rightarrow 1} (x - 1)^2 q(x) = \lim_{x \rightarrow 1} \frac{\alpha\beta(x - 1)}{x} = 0.$$

Hence  $x = 1$  is a *regular* singular point. The indicial equation is

$$r^2 - (\gamma - \alpha - \beta)r = 0,$$

with roots  $r_1 = \gamma - \alpha - \beta$  and  $r_2 = 0$ .

(c). Given that  $r_1 - r_2$  is not a positive integer, we can set  $y = \sum_{n=0}^{\infty} a_n x^n$ . Substitution into the ODE results in

$$x(1 - x) \sum_{n=2}^{\infty} n(n - 1)a_n x^{n-2} + [\gamma - (1 + \alpha + \beta)x] \sum_{n=1}^{\infty} n a_n x^{n-1} - \alpha\beta \sum_{n=0}^{\infty} a_n x^n = 0.$$

That is,

$$\begin{aligned} \sum_{n=1}^{\infty} n(n + 1)a_{n+1}x^n - \sum_{n=2}^{\infty} n(n - 1)a_n x^n + \gamma \sum_{n=0}^{\infty} (n + 1)a_{n+1}x^n - \\ - (1 + \alpha + \beta) \sum_{n=1}^{\infty} n a_n x^n - \alpha\beta \sum_{n=0}^{\infty} a_n x^n = 0. \end{aligned}$$

Combining the series, we obtain

$$\gamma a_1 - \alpha\beta a_0 + [(2 + 2\gamma)a_2 - (1 + \alpha + \beta + \alpha\beta)a_1]x + \sum_{n=2}^{\infty} A_n x^n = 0,$$

in which

$$A_n = (n+1)(n+\gamma)a_{n+1} - [n(n-1) + (1+\alpha+\beta)n + \alpha\beta]a_n.$$

Note that  $n(n-1) + (1+\alpha+\beta)n + \alpha\beta = (n+\alpha)(n+\beta)$ . Setting the coefficients equal to zero, we have  $\gamma a_1 - \alpha\beta a_0 = 0$ , and

$$a_{n+1} = \frac{(n+\alpha)(n+\beta)}{(n+1)(n+\gamma)} a_n$$

for  $n \geq 1$ . Hence one solution is

$$\begin{aligned} y_1(x) = & 1 + \frac{\alpha\beta}{\gamma \cdot 1!}x + \frac{\alpha(\alpha+1)\beta(\beta+1)}{\gamma(\gamma+1) \cdot 2!}x^2 + \\ & + \frac{\alpha(\alpha+1)(\alpha+2)\beta(\beta+1)(\beta+2)}{\gamma(\gamma+1)(\gamma+2) \cdot 3!}x^3 + \dots \end{aligned}$$

Since the nearest other singularity is at  $x = 1$ , the radius of convergence of  $y_1(x)$  will be at least  $\rho = 1$ .

(d). Given that  $r_1 - r_2$  is not a positive integer, we can set  $y = x^{1-\gamma} \sum_{n=0}^{\infty} b_n x^n$ . Then

Substitution into the ODE results in

$$\begin{aligned} & x(1-x) \sum_{n=0}^{\infty} (n+1-\gamma)(n-\gamma)a_n x^{n-\gamma-1} + \\ & + [\gamma - (1+\alpha+\beta)x] \sum_{n=0}^{\infty} (n+1-\gamma)a_n x^{n-\gamma} - \alpha\beta \sum_{n=0}^{\infty} a_n x^{n+1-\gamma} = 0. \end{aligned}$$

That is,

$$\begin{aligned} & \sum_{n=0}^{\infty} (n+1-\gamma)(n-\gamma)a_n x^{n-\gamma} - \sum_{n=0}^{\infty} (n+1-\gamma)(n-\gamma)a_n x^{n+1-\gamma} + \\ & + \gamma \sum_{n=0}^{\infty} (n+1-\gamma)a_n x^{n-\gamma} - (1+\alpha+\beta) \sum_{n=0}^{\infty} (n+1-\gamma)a_n x^{n+1-\gamma} - \alpha\beta \sum_{n=0}^{\infty} a_n x^{n+1-\gamma} = 0. \end{aligned}$$

After adjusting the indices,

$$\begin{aligned} & \sum_{n=0}^{\infty} (n+1-\gamma)(n-\gamma)a_n x^{n-\gamma} - \sum_{n=1}^{\infty} (n-\gamma)(n-1-\gamma)a_{n-1} x^{n-\gamma} + \\ & + \gamma \sum_{n=0}^{\infty} (n+1-\gamma)a_n x^{n-\gamma} - (1+\alpha+\beta) \sum_{n=1}^{\infty} (n-\gamma)a_{n-1} x^{n-\gamma} - \alpha\beta \sum_{n=1}^{\infty} a_{n-1} x^{n-\gamma} = 0. \end{aligned}$$

Combining the series, we obtain

$$\sum_{n=1}^{\infty} B_n x^{n-\gamma} = 0,$$

in which



$$B_n = n(n+1-\gamma)b_n - [(n-\gamma)(n-\gamma+\alpha+\beta) + \alpha\beta]b_{n-1}.$$

Note that  $(n-\gamma)(n-\gamma+\alpha+\beta) + \alpha\beta = (n+\alpha-\gamma)(n+\beta-\gamma)$ . Setting  $B_n = 0$ , it follows that for  $n \geq 1$ ,

$$b_n = \frac{(n+\alpha-\gamma)(n+\beta-\gamma)}{n(n+1-\gamma)} b_{n-1}.$$

Therefore a second solution is

$$y_2(x) = x^{1-\gamma} \left[ 1 + \frac{(1+\alpha-\gamma)(1+\beta-\gamma)}{(2-\gamma)1!} x + \frac{(1+\alpha-\gamma)(2+\alpha-\gamma)(1+\beta-\gamma)(2+\beta-\gamma)}{(2-\gamma)(3-\gamma)2!} x^2 + \dots \right].$$

(e). Under the transformation  $x = 1/\xi$ , the ODE becomes

$$\xi^4 \frac{1}{\xi} \left( 1 - \frac{1}{\xi} \right) \frac{d^2 y}{d\xi^2} + \left\{ 2\xi^3 \frac{1}{\xi} \left( 1 - \frac{1}{\xi} \right) - \xi^2 \left[ \gamma - (1+\alpha+\beta) \frac{1}{\xi} \right] \right\} \frac{dy}{d\xi} - \alpha\beta y = 0.$$

That is,

$$(\xi^3 - \xi^2) \frac{d^2 y}{d\xi^2} + [2\xi^2 - \gamma\xi^2 + (-1 + \alpha + \beta)\xi] \frac{dy}{d\xi} - \alpha\beta y = 0.$$

Therefore  $\xi = 0$  is a singular point. Note that

$$p(\xi) = \frac{(2-\gamma)\xi + (-1 + \alpha + \beta)}{\xi^2 - \xi} \quad \text{and} \quad q(\xi) = \frac{-\alpha\beta}{\xi^3 - \xi^2}.$$

It follows that

$$p_0 = \lim_{\xi \rightarrow 0} \xi p(\xi) = \lim_{\xi \rightarrow 0} \frac{(2-\gamma)\xi + (-1 + \alpha + \beta)}{\xi - 1} = 1 - \alpha - \beta,$$

$$q_0 = \lim_{\xi \rightarrow 0} \xi^2 q(\xi) = \lim_{\xi \rightarrow 0} \frac{-\alpha\beta}{\xi - 1} = \alpha\beta.$$

Hence  $\xi = 0$  ( $x = \infty$ ) is a *regular* singular point. The indicial equation is

$$r(r-1) + (1 - \alpha - \beta)r + \alpha\beta = 0,$$

or  $r^2 - (\alpha + \beta)r + \alpha\beta = 0$ . Evidently, the roots are  $r = \alpha$  and  $r = \beta$ .

21(a). Note that

$$p(x) = \frac{\alpha}{x^s} \quad \text{and} \quad q(\xi) = \frac{\beta}{x^t}.$$

It follows that

$$\lim_{x \rightarrow 0} x p(x) = \lim_{x \rightarrow 0} \alpha x^{1-s},$$

$$\lim_{\xi \rightarrow 0} \xi^2 q(\xi) = \lim_{\xi \rightarrow 0} \beta x^{2-s}.$$

Hence if  $s > 1$  or  $t > 2$ , one or both of the limits does not exist. Therefore  $x = 0$  is an *irregular* singular point.

(c). Let  $y = a_0 x^r + a_1 x^{r+1} + \dots + a_n x^{r+n} + \dots$ . Write the ODE as

$$x^3 y'' + \alpha x^2 y' + \beta y = 0.$$

Substitution of the assumed solution results in

$$\sum_{n=0}^{\infty} (n+r)(n+r-1) a_n x^{n+r+1} + \alpha \sum_{n=0}^{\infty} (n+r) a_n x^{n+r+1} + \beta \sum_{n=0}^{\infty} a_n x^{n+r} = 0.$$

Adjusting the indices, we obtain

$$\sum_{n=1}^{\infty} (n-1+r)(n+r-2) a_{n-1} x^{n+r} + \alpha \sum_{n=1}^{\infty} (n-1+r) a_{n-1} x^{n+r} + \beta \sum_{n=0}^{\infty} a_n x^{n+r} = 0.$$

Combining the series,

$$\beta a_0 + \sum_{n=1}^{\infty} A_n x^{n+r} = 0,$$

in which  $A_n = \beta a_n + (n-1+r)(n+r+\alpha-2) a_{n-1}$ . Setting the coefficients equal to zero, we have  $a_0 = 0$ . But for  $n \geq 1$ ,

$$a_n = \frac{(n-1+r)(n+r+\alpha-2)}{\beta} a_{n-1}.$$

Therefore, regardless of the value of  $r$ , it follows that  $a_n = 0$ , for  $n = 1, 2, \dots$ .

## Section 5.8

3. Here  $x p(x) = 1$  and  $x^2 q(x) = 2x$ , which are both analytic everywhere. We set  $y = x^r(a_0 + a_1x + a_2x^2 + \cdots + a_nx^n + \cdots)$ . Substitution into the ODE results in

$$\sum_{n=0}^{\infty} (r+n)(r+n-1)a_n x^{r+n} + \sum_{n=0}^{\infty} (r+n)a_n x^{r+n} + 2 \sum_{n=0}^{\infty} a_n x^{r+n+1} = 0.$$

After adjusting the indices in the *last* series, we obtain

$$a_0[r(r-1) + r]x^r + \sum_{n=1}^{\infty} [(r+n)(r+n-1)a_n + (r+n)a_n + 2a_{n-1}]x^{r+n} = 0.$$

Assuming  $a_0 \neq 0$ , the *indicial equation* is  $r^2 = 0$ , with *double root*  $r = 0$ . Setting the remaining coefficients equal to *zero*, we have for  $n \geq 1$ ,

$$a_n(r) = -\frac{2}{(n+r)^2} a_{n-1}(r).$$

It follows that

$$a_n(r) = \frac{(-1)^n 2^n}{[(n+r)(n+r-1)\cdots(1+r)]^2} a_0, \quad n \geq 1.$$

Since  $r = 0$ , one solution is given by

$$y_1(x) = \sum_{n=0}^{\infty} \frac{(-1)^n 2^n}{(n!)^2} x^n.$$

For a second linearly independent solution, we follow the discussion in Section 5.7.

First

note that

$$\frac{a'_n(r)}{a_n(r)} = -2 \left[ \frac{1}{n+r} + \frac{1}{n+r-1} + \cdots + \frac{1}{1+r} \right].$$

Setting  $r = 0$ ,

$$a'_n(0) = -2 H_n a_n(0) = -2 H_n \frac{(-1)^n 2^n}{(n!)^2}.$$

Therefore,

$$y_2(x) = y_1(x) \ln x - 2 \sum_{n=0}^{\infty} \frac{(-1)^n 2^n H_n}{(n!)^2} x^n.$$

4. Here  $x p(x) = 4$  and  $x^2 q(x) = 2 + x$ , which are both analytic everywhere. We set  $y = x^r(a_0 + a_1x + a_2x^2 + \cdots + a_nx^n + \cdots)$ . Substitution into the ODE results in

$$\begin{aligned} \sum_{n=0}^{\infty} (r+n)(r+n-1)a_n x^{r+n} + 4 \sum_{n=0}^{\infty} (r+n)a_n x^{r+n} + \\ + \sum_{n=0}^{\infty} a_n x^{r+n+1} + 2 \sum_{n=0}^{\infty} a_n x^{r+n} = 0. \end{aligned}$$

After adjusting the indices in the *second-to-last* series, we obtain

$$a_0[r(r-1) + 4r + 2]x^r + \sum_{n=1}^{\infty} [(r+n)(r+n-1)a_n + 4(r+n)a_n + 2a_n + a_{n-1}]x^{r+n} = 0.$$

Assuming  $a_0 \neq 0$ , the *indicial equation* is  $r^2 + 3r + 2 = 0$ , with roots  $r_1 = -1$  and  $r_2 = -2$ . Setting the remaining coefficients equal to *zero*, we have for  $n \geq 1$ ,

$$a_n(r) = - \frac{1}{(n+r+1)(n+r+2)} a_{n-1}(r).$$

It follows that

$$a_n(r) = \frac{(-1)^n}{[(n+r+1)(n+r)\cdots(2+r)][(n+r+2)(n+r)\cdots(3+r)]} a_0, \quad n \geq 1.$$

Since  $r_1 = -1$ , one solution is given by

$$y_1(x) = x^{-1} \sum_{n=0}^{\infty} \frac{(-1)^n}{(n)!(n+1)!} x^n.$$

For a second linearly independent solution, we follow the discussion in Section 5.7. Since  $r_1 - r_2 = N = 1$ , we find that

$$a_1(r) = - \frac{1}{(r+2)(r+3)},$$

with  $a_0 = 1$ . Hence the leading coefficient in the solution is

$$a = \lim_{r \rightarrow -2} (r+2) a_1(r) = -1.$$

Further,

$$(r+2) a_n(r) = \frac{(-1)^n}{(n+r+2)[(n+r+1)(n+r)\cdots(3+r)]^2}.$$

Let  $A_n(r) = (r+2) a_n(r)$ . It follows that

$$\frac{A'_n(r)}{A_n(r)} = - \frac{1}{n+r+2} - 2 \left[ \frac{1}{n+r+1} + \frac{1}{n+r} + \cdots + \frac{1}{3+r} \right].$$

Setting  $r = r_2 = -2$ ,

$$\begin{aligned}\frac{A'_n(-2)}{A_n(-2)} &= -\frac{1}{n} - 2 \left[ \frac{1}{n-1} + \frac{1}{n-2} + \cdots + 1 \right] \\ &= -H_n - H_{n-1}.\end{aligned}$$

Hence

$$\begin{aligned}c_n(-2) &= -(H_n + H_{n-1}) A_n(-2) \\ &= -(H_n + H_{n-1}) \frac{(-1)^n}{n!(n-1)!}.\end{aligned}$$

Therefore,

$$y_2(x) = -y_1(x) \ln x + x^{-2} \left[ 1 - \sum_{n=1}^{\infty} \frac{(-1)^n (H_n + H_{n-1})}{n!(n-1)!} x^n \right].$$

6. Let  $y(x) = v(x)/\sqrt{x}$ . Then  $y' = x^{-1/2} v' - x^{-3/2} v/2$  and  $y'' = x^{-1/2} v'' - x^{-3/2} v' + 3x^{-5/2} v/4$ . Substitution into the ODE results in

$$[x^{3/2} v'' - x^{1/2} v' + 3x^{-1/2} v/4] + [x^{1/2} v' - x^{-1/2} v/2] + \left(x^2 - \frac{1}{4}\right) x^{-1/2} v = 0.$$

Simplifying, we find that

$$v'' + v = 0,$$

with *general solution*  $v(x) = c_1 \cos x + c_2 \sin x$ . Hence

$$y(x) = c_1 x^{-1/2} \cos x + c_2 x^{-1/2} \sin x.$$

8. The absolute value of the ratio of consecutive terms is

$$\left| \frac{a_{2m+2} x^{2m+2}}{a_{2m} x^{2m}} \right| = \frac{|x|^{2m+2} 2^{2m} (m+1)! m!}{|x|^{2m} 2^{2m+2} (m+2)! (m+1)!} = \frac{|x|^2}{4(m+2)(m+1)}.$$

Applying the *ratio test*,

$$\lim_{m \rightarrow \infty} \left| \frac{a_{2m+2} x^{2m+2}}{a_{2m} x^{2m}} \right| = \lim_{m \rightarrow \infty} \frac{|x|^2}{4(m+2)(m+1)} = 0.$$

Hence the series for  $J_1(x)$  converges absolutely *for all* values of  $x$ . Furthermore, since the series for  $J_0(x)$  also converges absolutely for all  $x$ , term-by-term differentiation results in

$$\begin{aligned}
 J_0'(x) &= \sum_{m=1}^{\infty} \frac{(-1)^m x^{2m-1}}{2^{2m-1} m!(m-1)!} \\
 &= \sum_{m=0}^{\infty} \frac{(-1)^{m+1} x^{2m+1}}{2^{2m+1} (m+1)! m!} \\
 &= -\frac{x}{2} \sum_{m=0}^{\infty} \frac{(-1)^m x^{2m}}{2^{2m} (m+1)! m!}.
 \end{aligned}$$

Therefore,  $J_0'(x) = -J_1(x)$ .

9(a). Note that  $x p(x) = 1$  and  $x^2 q(x) = x^2 - \nu^2$ , which are *both* analytic at  $x = 0$ . Thus  $x = 0$  is a *regular* singular point. Furthermore,  $p_0 = 1$  and  $q_0 = -\nu^2$ . Hence the *indicial equation* is  $r^2 - \nu^2 = 0$ , with roots  $r_1 = \nu$  and  $r_2 = -\nu$ .

(b). Set  $y = x^r(a_0 + a_1x + a_2x^2 + \cdots + a_nx^n + \cdots)$ . Substitution into the ODE results in

$$\begin{aligned}
 \sum_{n=0}^{\infty} (r+n)(r+n-1)a_n x^{r+n} + \sum_{n=0}^{\infty} (r+n)a_n x^{r+n} + \\
 + \sum_{n=0}^{\infty} a_n x^{r+n+2} - \nu^2 \sum_{n=0}^{\infty} a_n x^{r+n} = 0.
 \end{aligned}$$

After adjusting the indices in the *second-to-last* series, we obtain

$$\begin{aligned}
 a_0 [r(r-1) + r - \nu^2] x^r + a_1 [(r+1)r + (r+1) - \nu^2] + \\
 + \sum_{n=2}^{\infty} [(r+n)(r+n-1)a_n + (r+n)a_n - \nu^2 a_n + a_{n-2}] x^{r+n} = 0.
 \end{aligned}$$

Setting the coefficients equal to *zero*, we find that  $a_1 = 0$ , and

$$a_n = \frac{-1}{(r+n)^2 - \nu^2} a_{n-2},$$

for  $n \geq 2$ . It follows that  $a_3 = a_5 = \cdots = a_{2m+1} = \cdots = 0$ . Furthermore, with  $r = \nu$ ,

$$a_n = \frac{-1}{n(n+2\nu)} a_{n-2}.$$

So for  $m = 1, 2, \dots$ ,

$$\begin{aligned}
 a_{2m} &= \frac{-1}{2m(2m+2\nu)} a_{2m-2} \\
 &= \frac{(-1)^m}{2^{2m} m!(1+\nu)(2+\nu)\cdots(m-1+\nu)(m+\nu)} a_0.
 \end{aligned}$$

Hence one solution is

$$y_1(x) = x^\nu \left[ 1 + \sum_{m=1}^{\infty} \frac{(-1)^m}{m!(1+\nu)(2+\nu)\cdots(m-1+\nu)(m+\nu)} \left(\frac{x}{2}\right)^{2m} \right].$$

(c). Assuming that  $r_1 - r_2 = 2\nu$  is *not* an integer, simply setting  $r = -\nu$  in the above results in a second *linearly independent* solution

$$y_2(x) = x^{-\nu} \left[ 1 + \sum_{m=1}^{\infty} \frac{(-1)^m}{m!(1-\nu)(2-\nu)\cdots(m-1-\nu)(m-\nu)} \left(\frac{x}{2}\right)^{2m} \right].$$

(d). The absolute value of the ratio of consecutive terms in  $y_1(x)$  is

$$\begin{aligned} \left| \frac{a_{2m+2} x^{2m+2}}{a_{2m} x^{2m}} \right| &= \frac{|x|^{2m+2} 2^{2m} m!(1+\nu)\cdots(m+\nu)}{|x|^{2m} 2^{2m+2} (m+1)!(1+\nu)\cdots(m+1+\nu)} \\ &= \frac{|x|^2}{4(m+1)(m+1+\nu)}. \end{aligned}$$

Applying the *ratio test*,

$$\lim_{m \rightarrow \infty} \left| \frac{a_{2m+2} x^{2m+2}}{a_{2m} x^{2m}} \right| = \lim_{m \rightarrow \infty} \frac{|x|^2}{4(m+1)(m+1+\nu)} = 0.$$

Hence the series for  $y_1(x)$  converges absolutely *for all* values of  $x$ . The same can be shown for  $y_2(x)$ . Note also, that if  $\nu$  is a *positive* integer, then the coefficients in the series for  $y_2(x)$  are *undefined*.

10(a). It suffices to calculate  $L[J_0(x) \ln x]$ . Indeed,

$$[J_0(x) \ln x]' = J_0'(x) \ln x + \frac{J_0(x)}{x}$$

and

$$[J_0(x) \ln x]'' = J_0''(x) \ln x + 2 \frac{J_0'(x)}{x} - \frac{J_0(x)}{x^2}.$$

Hence

$$\begin{aligned} L[J_0(x) \ln x] &= x^2 J_0''(x) \ln x + 2x J_0'(x) - J_0(x) + \\ &\quad + x J_0'(x) \ln x + J_0(x) + x^2 J_0(x) \ln x. \end{aligned}$$

Since  $x^2 J_0''(x) + x J_0'(x) + x^2 J_0(x) = 0$ ,

$$L[J_0(x) \ln x] = 2x J_0'(x).$$

(b). Given that  $L[y_2(x)] = 0$ , after adjusting the indices in Part (a), we have

$$b_1x + 2^2b_2x^2 + \sum_{n=3}^{\infty} (n^2b_n + b_{n-2})x^n = -2xJ_0'(x).$$

Using the series representation of  $J_0'(x)$  in Problem 8,

$$b_1x + 2^2b_2x^2 + \sum_{n=3}^{\infty} (n^2b_n + b_{n-2})x^n = -2 \sum_{n=1}^{\infty} \frac{(-1)^n(2n)x^{2n}}{2^{2n}(n!)^2}.$$

(c). Equating the coefficients on both sides of the equation, we find that

$$b_1 = b_3 = \cdots = b_{2m+1} = \cdots = 0.$$

Also, with  $n = 1$ ,  $2^2b_2 = 1/(1!)^2$ , that is,  $b_2 = 1/[2^2(1!)^2]$ . Furthermore, for  $m \geq 2$ ,

$$(2m)^2b_{2m} + b_{2m-2} = -2 \frac{(-1)^m(2m)}{2^{2m}(m!)^2}.$$

More explicitly,

$$\begin{aligned} b_4 &= -\frac{1}{2^2 4^2} \left(1 + \frac{1}{2}\right) \\ b_6 &= \frac{1}{2^2 4^2 6^2} \left(1 + \frac{1}{2} + \frac{1}{3}\right) \\ &\vdots \end{aligned}$$

It can be shown, in general, that

$$b_{2m} = (-1)^{m+1} \frac{H_m}{2^{2m}(m!)^2}.$$

11. Bessel's equation of *order one* is

$$x^2 y'' + x y' + (x^2 - 1)y = 0.$$

Based on Problem 9, the roots of the indicial equation are  $r_1 = 1$  and  $r_2 = -1$ . Set  $y = x^r(a_0 + a_1x + a_2x^2 + \cdots + a_nx^n + \cdots)$ . Substitution into the ODE results in

$$\begin{aligned} \sum_{n=0}^{\infty} (r+n)(r+n-1)a_n x^{r+n} + \sum_{n=0}^{\infty} (r+n)a_n x^{r+n} + \\ + \sum_{n=0}^{\infty} a_n x^{r+n+2} - \sum_{n=0}^{\infty} a_n x^{r+n} = 0. \end{aligned}$$

After adjusting the indices in the *second-to-last* series, we obtain



$$a_0[r(r-1) + r - 1]x^r + a_1[(r+1)r + (r+1) - 1] + \sum_{n=2}^{\infty} [(r+n)(r+n-1)a_n + (r+n)a_n - a_n + a_{n-2}]x^{r+n} = 0.$$

Setting the coefficients equal to *zero*, we find that  $a_1 = 0$ , and

$$\begin{aligned} a_n(r) &= \frac{-1}{(r+n)^2 - 1} a_{n-2}(r) \\ &= \frac{-1}{(n+r+1)(n+r-1)} a_{n-2}(r), \end{aligned}$$

for  $n \geq 2$ . It follows that  $a_3 = a_5 = \dots = a_{2m+1} = \dots = 0$ . Solving the recurrence relation,

$$a_{2m}(r) = \frac{(-1)^m}{(2m+r+1)(2m+r-1)^2 \dots (r+3)^2(r+1)} a_0.$$

With  $r = r_1 = 1$ ,

$$a_{2m}(1) = \frac{(-1)^m}{2^{2m}(m+1)!m!} a_0.$$

For a *second* linearly independent solution, we follow the discussion in Section 5.7. Since  $r_1 - r_2 = N = 2$ , we find that

$$a_2(r) = -\frac{1}{(r+3)(r+1)},$$

with  $a_0 = 1$ . Hence the leading coefficient in the solution is

$$a = \lim_{r \rightarrow -1} (r+1) a_2(r) = -\frac{1}{2}.$$

Further,

$$(r+1) a_{2m}(r) = \frac{(-1)^m}{(2m+r+1)[(2m+r-1)\dots(3+r)]^2}.$$

Let  $A_n(r) = (r+1) a_n(r)$ . It follows that

$$\frac{A'_{2m}(r)}{A_{2m}(r)} = -\frac{1}{2m+r+1} - 2 \left[ \frac{1}{2m+r-1} + \dots + \frac{1}{3+r} \right].$$

Setting  $r = r_2 = -1$ , we calculate

$$\begin{aligned}
 c_{2m}(-1) &= -\frac{1}{2}(H_m + H_{m-1})A_{2m}(-1) \\
 &= -\frac{1}{2}(H_m + H_{m-1})\frac{(-1)^m}{2m[(2m-2)\cdots 2]^2} \\
 &= -\frac{1}{2}(H_m + H_{m-1})\frac{(-1)^m}{2^{2m-1}m!(m-1)!}.
 \end{aligned}$$

Note that  $a_{2m+1}(r) = 0$  implies that  $A_{2m+1}(r) = 0$ , so

$$c_{2m+1}(-1) = \left[ \frac{d}{dr} A_{2m+1}(r) \right]_{r=r_2} = 0.$$

Therefore,

$$y_2(x) = -\frac{1}{2} \left[ x \sum_{m=0}^{\infty} \frac{(-1)^m}{(m+1)!m!} \left(\frac{x}{2}\right)^{2m} \right] \ln x + \frac{1}{x} \left[ 1 - \sum_{m=1}^{\infty} \frac{(-1)^m(H_m + H_{m-1})}{m!(m-1)!} \left(\frac{x}{2}\right)^{2m} \right].$$

Based on the definition of  $J_1(x)$ ,

$$y_2(x) = -J_1(x) \ln x + \frac{1}{x} \left[ 1 - \sum_{m=1}^{\infty} \frac{(-1)^m(H_m + H_{m-1})}{m!(m-1)!} \left(\frac{x}{2}\right)^{2m} \right].$$

12. Consider a solution of the form

$$y(x) = \sqrt{x} f(\alpha x^\beta).$$

Then

$$y' = \frac{df}{d\xi} \cdot \frac{\alpha\beta x^\beta}{\sqrt{x}} + \frac{f(\xi)}{2\sqrt{x}}$$

in which  $\xi = \alpha x^\beta$ . Hence

$$y'' = \frac{d^2f}{d\xi^2} \cdot \frac{\alpha^2\beta^2 x^{2\beta}}{x\sqrt{x}} + \frac{df}{d\xi} \cdot \frac{\alpha\beta^2 x^\beta}{x\sqrt{x}} - \frac{f(\xi)}{4x\sqrt{x}},$$

and

$$x^2 y'' = \alpha^2\beta^2 x^{2\beta} \sqrt{x} \frac{d^2f}{d\xi^2} + \alpha\beta^2 x^\beta \sqrt{x} \frac{df}{d\xi} - \frac{1}{4} \sqrt{x} f(\xi).$$

Substitution into the ODE results in

$$\alpha^2\beta^2 x^{2\beta} \frac{d^2f}{d\xi^2} + \alpha\beta^2 x^\beta \frac{df}{d\xi} - \frac{1}{4} f(\xi) + \left( \alpha^2\beta^2 x^{2\beta} + \frac{1}{4} - \nu^2\beta^2 \right) f(\xi) = 0.$$

Simplifying, and setting  $\xi = \alpha x^\beta$ , we find that

$$\xi^2 \frac{d^2 f}{d\xi^2} + \xi \frac{df}{d\xi} + (\xi^2 - \nu^2)f(\xi) = 0, \quad (*)$$

which is a *Bessel* equation of order  $\nu$ . Therefore, the general solution of the given ODE is

$$y(x) = \sqrt{x} [c_1 f_1(\alpha x^\beta) + c_2 f_2(\alpha x^\beta)],$$

in which  $f_1(\xi)$  and  $f_2(\xi)$  are the linearly independent solutions of (\*).

## Chapter Six

### Section 6.1

3.

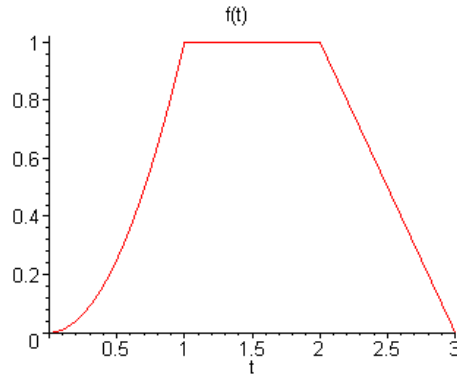

The function  $f(t)$  is *continuous*.

4.

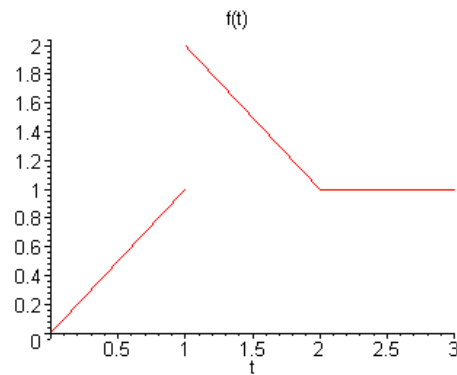

The function  $f(t)$  has a *jump discontinuity* at  $t = 1$ .

7. Integration is a linear operation. It follows that

$$\begin{aligned} \int_0^A \cosh bt \cdot e^{-st} dt &= \frac{1}{2} \int_0^A e^{bt} \cdot e^{-st} dt + \frac{1}{2} \int_0^A e^{-bt} \cdot e^{-st} dt \\ &= \frac{1}{2} \int_0^A e^{(b-s)t} dt + \frac{1}{2} \int_0^A e^{-(b+s)t} dt. \end{aligned}$$

Hence

$$\int_0^A \cosh bt \cdot e^{-st} dt = \frac{1}{2} \left[ \frac{1 - e^{(b-s)A}}{s - b} \right] + \frac{1}{2} \left[ \frac{1 - e^{-(b+s)A}}{s + b} \right].$$

Taking a *limit*, as  $A \rightarrow \infty$ ,

$$\begin{aligned}\int_0^\infty \cosh bt \cdot e^{-st} dt &= \frac{1}{2} \left[ \frac{1}{s-b} \right] + \frac{1}{2} \left[ \frac{1}{s+b} \right] \\ &= \frac{s}{s^2 - b^2}.\end{aligned}$$

Note that the above is valid for  $s > |b|$ .

8. Proceeding as in Prob. 7,

$$\int_0^A \sinh bt \cdot e^{-st} dt = \frac{1}{2} \left[ \frac{1 - e^{(b-s)A}}{s-b} \right] - \frac{1}{2} \left[ \frac{1 - e^{-(b+s)A}}{s+b} \right].$$

Taking a *limit*, as  $A \rightarrow \infty$ ,

$$\begin{aligned}\int_0^\infty \sinh bt \cdot e^{-st} dt &= \frac{1}{2} \left[ \frac{1}{s-b} \right] - \frac{1}{2} \left[ \frac{1}{s+b} \right] \\ &= \frac{b}{s^2 - b^2}.\end{aligned}$$

The limit exists as long as  $s > |b|$ .

10. Observe that  $e^{at} \sinh bt = (e^{(a+b)t} - e^{(a-b)t})/2$ . It follows that

$$\int_0^A e^{at} \sinh bt \cdot e^{-st} dt = \frac{1}{2} \left[ \frac{1 - e^{(a+b-s)A}}{s-a+b} \right] - \frac{1}{2} \left[ \frac{1 - e^{-(b-a+s)A}}{s+b-a} \right].$$

Taking a *limit*, as  $A \rightarrow \infty$ ,

$$\begin{aligned}\int_0^\infty e^{at} \sinh bt \cdot e^{-st} dt &= \frac{1}{2} \left[ \frac{1}{s-a+b} \right] - \frac{1}{2} \left[ \frac{1}{s+b-a} \right] \\ &= \frac{b}{(s-a)^2 - b^2}.\end{aligned}$$

The limit exists as long as  $s - a > |b|$ .

11. Using the *linearity* of the Laplace transform,

$$\mathcal{L}[\sin bt] = \frac{1}{2i} \mathcal{L}[e^{ibt}] - \frac{1}{2i} \mathcal{L}[e^{-ibt}].$$

Since

$$\int_0^\infty e^{(a+ib)t} e^{-st} dt = \frac{1}{s-a-ib},$$

we have

$$\int_0^{\infty} e^{\pm ibt} e^{-st} dt = \frac{1}{s \mp ib}.$$

Therefore

$$\begin{aligned} \mathcal{L}[\sin bt] &= \frac{1}{2i} \left[ \frac{1}{s - ib} - \frac{1}{s + ib} \right] \\ &= \frac{b}{s^2 + b^2}. \end{aligned}$$

12. Using the *linearity* of the Laplace transform,

$$\mathcal{L}[\cos bt] = \frac{1}{2} \mathcal{L}[e^{ibt}] + \frac{1}{2} \mathcal{L}[e^{-ibt}].$$

From Prob. 11, we have

$$\int_0^{\infty} e^{\pm ibt} e^{-st} dt = \frac{1}{s \mp ib}.$$

Therefore

$$\begin{aligned} \mathcal{L}[\cos bt] &= \frac{1}{2} \left[ \frac{1}{s - ib} + \frac{1}{s + ib} \right] \\ &= \frac{s}{s^2 + b^2}. \end{aligned}$$

14. Using the *linearity* of the Laplace transform,

$$\mathcal{L}[e^{at} \cos bt] = \frac{1}{2} \mathcal{L}[e^{(a+ib)t}] + \frac{1}{2} \mathcal{L}[e^{(a-ib)t}].$$

Based on the integration in Prob. 11,

$$\int_0^{\infty} e^{(a \pm ib)t} e^{-st} dt = \frac{1}{s - a \mp ib}.$$

Therefore

$$\begin{aligned} \mathcal{L}[e^{at} \cos bt] &= \frac{1}{2} \left[ \frac{1}{s - a - ib} + \frac{1}{s - a + ib} \right] \\ &= \frac{s - a}{(s - a)^2 + b^2}. \end{aligned}$$

The above is valid for  $s > a$ .

15. Integrating *by parts*,

$$\begin{aligned}\int_0^A t e^{at} \cdot e^{-st} dt &= -\left. \frac{t e^{(a-s)t}}{s-a} \right|_0^A + \int_0^A \frac{1}{s-a} e^{(a-s)t} dt \\ &= \frac{1 - e^{A(a-s)} + A(a-s)e^{A(a-s)}}{(s-a)^2}.\end{aligned}$$

Taking a *limit*, as  $A \rightarrow \infty$ ,

$$\int_0^\infty t e^{at} \cdot e^{-st} dt = \frac{1}{(s-a)^2}.$$

Note that the limit exists as long as  $s > a$ .

17. Observe that  $t \cosh at = (t e^{at} + t e^{-at})/2$ . For any value of  $c$ ,

$$\begin{aligned}\int_0^A t e^{ct} \cdot e^{-st} dt &= -\left. \frac{t e^{(c-s)t}}{s-c} \right|_0^A + \int_0^A \frac{1}{s-c} e^{(c-s)t} dt \\ &= \frac{1 - e^{A(c-s)} + A(c-s)e^{A(c-s)}}{(s-c)^2}.\end{aligned}$$

Taking a *limit*, as  $A \rightarrow \infty$ ,

$$\int_0^\infty t e^{ct} \cdot e^{-st} dt = \frac{1}{(s-c)^2}.$$

Note that the limit exists as long as  $s > |c|$ . Therefore,

$$\begin{aligned}\int_0^\infty t \cosh at \cdot e^{-st} dt &= \frac{1}{2} \left[ \frac{1}{(s-a)^2} + \frac{1}{(s+a)^2} \right] \\ &= \frac{s^2 + a^2}{(s-a)^2 (s+a)^2}.\end{aligned}$$

18. Integrating *by parts*,

$$\begin{aligned}\int_0^A t^n e^{at} \cdot e^{-st} dt &= -\left. \frac{t^n e^{(a-s)t}}{s-a} \right|_0^A + \int_0^A \frac{n}{s-a} t^{n-1} e^{(a-s)t} dt \\ &= -\frac{A^n e^{-(s-a)A}}{s-a} + \int_0^A \frac{n}{s-a} t^{n-1} e^{(a-s)t} dt.\end{aligned}$$

Continuing to integrate by parts, it follows that

$$\int_0^A t^n e^{at} \cdot e^{-st} dt = -\frac{A^n e^{(a-s)A}}{s-a} - \frac{nA^{n-1} e^{(a-s)A}}{(s-a)^2} - \frac{n! A e^{(a-s)A}}{(n-2)!(s-a)^3} - \dots - \frac{n!(e^{(a-s)A} - 1)}{(s-a)^{n+1}}.$$

That is,

$$\int_0^A t^n e^{at} \cdot e^{-st} dt = p_n(A) \cdot e^{(a-s)A} + \frac{n!}{(s-a)^{n+1}},$$

in which  $p_n(\xi)$  is a *polynomial* of degree  $n$ . For any given polynomial,

$$\lim_{A \rightarrow \infty} p_n(A) \cdot e^{-(s-a)A} = 0,$$

as long as  $s > a$ . Therefore,

$$\int_0^\infty t^n e^{at} \cdot e^{-st} dt = \frac{n!}{(s-a)^{n+1}}.$$

20. Observe that  $t^2 \sinh at = (t^2 e^{at} - t^2 e^{-at})/2$ . Using the result in Prob. 18,

$$\begin{aligned} \int_0^\infty t^2 \sinh at \cdot e^{-st} dt &= \frac{1}{2} \left[ \frac{2!}{(s-a)^3} - \frac{2!}{(s+a)^3} \right] \\ &= \frac{2a(3s^2 + a^2)}{(s^2 - a^2)^3}. \end{aligned}$$

The above is valid for  $s > |a|$ .

22. Integrating by parts,

$$\begin{aligned} \int_0^A t e^{-t} dt &= -t e^{-t} \Big|_0^A + \int_0^A e^{-t} dt \\ &= 1 - e^{-A} - A e^{-A}. \end{aligned}$$

Taking a *limit*, as  $A \rightarrow \infty$ ,

$$\int_0^\infty t e^{-t} dt = 1 - e^{-A}.$$

Hence the integral *converges*.

23. Based on a series expansion, note that for  $t > 0$ ,

$$e^t > 1 + t + t^2/2 > t^2/2.$$



It follows that for  $t > 0$ ,

$$t^{-2}e^t > \frac{1}{2}.$$

Hence for any finite  $A > 1$ ,

$$\int_1^A t^{-2}e^t dt > \frac{A-1}{2}.$$

It is evident that the limit as  $A \rightarrow \infty$  does not exist.

24. Using the fact that  $|\cos t| \leq 1$ , and the fact that

$$\int_0^\infty e^{-t} dt = 1,$$

it follows that the given integral *converges*.

25(a). Let  $p > 0$ . Integrating *by parts*,

$$\begin{aligned} \int_0^A e^{-x} x^p dx &= -e^{-x} x^p \Big|_0^A + p \int_0^A e^{-x} x^{p-1} dx \\ &= -A^p e^{-A} + p \int_0^A e^{-x} x^{p-1} dx. \end{aligned}$$

Taking a *limit*, as  $A \rightarrow \infty$ ,

$$\int_0^\infty e^{-x} x^p dx = p \int_0^\infty e^{-x} x^{p-1} dx.$$

That is,  $\Gamma(p+1) = p\Gamma(p)$ .

(b). Setting  $p = 0$ ,

$$\Gamma(1) = \int_0^\infty e^{-x} dx = 1.$$

(c). Let  $p = n$ . Using the result in Part (b),

$$\begin{aligned} \Gamma(n+1) &= n\Gamma(n) \\ &= n(n-1)\Gamma(n-1) \\ &\quad \vdots \\ &= n(n-1)(n-2)\cdots 2 \cdot 1 \cdot \Gamma(1). \end{aligned}$$

Since  $\Gamma(1) = 1$ ,  $\Gamma(n+1) = n!$ .

(d). Using the result in Part (b),

$$\begin{aligned}
\Gamma(p+n) &= (p+n-1)\Gamma(p+n-1) \\
&= (p+n-1)(p+n-2)\Gamma(p+n-2) \\
&\quad \vdots \\
&= (p+n-1)(p+n-2)\cdots(p+1)p\Gamma(p).
\end{aligned}$$

Hence

$$\frac{\Gamma(p+n)}{\Gamma(p)} = p(p+1)(p+1)\cdots(p+n-1).$$

Given that  $\Gamma(1/2) = \sqrt{\pi}$ , it follows that

$$\Gamma\left(\frac{3}{2}\right) = \frac{1}{2}\Gamma\left(\frac{1}{2}\right) = \frac{\sqrt{\pi}}{2}$$

and

$$\Gamma\left(\frac{11}{2}\right) = \frac{9}{2} \cdot \frac{7}{2} \cdot \frac{5}{2} \cdot \frac{3}{2} \Gamma\left(\frac{3}{2}\right) = \frac{945\sqrt{\pi}}{32}.$$

## Section 6.2

1. Write the function as

$$\frac{3}{s^2 + 4} = \frac{3}{2} \frac{2}{s^2 + 4}.$$

Hence  $\mathcal{L}^{-1}[Y(s)] = \frac{3}{2} \sin 2t$ .

3. Using *partial fractions*,

$$\frac{2}{s^2 + 3s - 4} = \frac{2}{5} \left[ \frac{1}{s - 1} - \frac{1}{s + 4} \right].$$

Hence  $\mathcal{L}^{-1}[Y(s)] = \frac{2}{5}(e^t - e^{-4t})$ .

5. Note that the denominator  $s^2 + 2s + 5$  is *irreducible* over the reals. Completing the square,  $s^2 + 2s + 5 = (s + 1)^2 + 4$ . Now convert the function to a *rational function* of the variable  $\xi = s + 1$ . That is,

$$\frac{2s + 2}{s^2 + 2s + 5} = \frac{2(s + 1)}{(s + 1)^2 + 4}.$$

We know that

$$\mathcal{L}^{-1} \left[ \frac{2\xi}{\xi^2 + 4} \right] = 2 \cos 2t.$$

Using the fact that  $\mathcal{L}[e^{at}f(t)] = \mathcal{L}[f(t)]_{s \rightarrow s-a}$ ,

$$\mathcal{L}^{-1} \left[ \frac{2s + 2}{s^2 + 2s + 5} \right] = 2e^{-t} \cos 2t.$$

6. Using *partial fractions*,

$$\frac{2s - 3}{s^2 - 4} = \frac{1}{4} \left[ \frac{1}{s - 2} + \frac{7}{s + 2} \right].$$

Hence  $\mathcal{L}^{-1}[Y(s)] = \frac{1}{4}(e^{2t} + 7e^{-2t})$ . Note that we can also write

$$\frac{2s - 3}{s^2 - 4} = 2 \frac{s}{s^2 - 4} - \frac{3}{2} \frac{2}{s^2 - 4}.$$

8. Using *partial fractions*,

$$\frac{8s^2 - 4s + 12}{s(s^2 + 4)} = 3 \frac{1}{s} + 5 \frac{s}{s^2 + 4} - 2 \frac{2}{s^2 + 4}.$$

Hence  $\mathcal{L}^{-1}[Y(s)] = 3 + 5 \cos 2t - 2 \sin 2t$ .

9. The denominator  $s^2 + 4s + 5$  is *irreducible* over the reals. Completing the square,  $s^2 + 4s + 5 = (s + 2)^2 + 1$ . Now convert the function to a *rational function* of the variable  $\xi = s + 2$ . That is,

$$\frac{1 - 2s}{s^2 + 4s + 5} = \frac{5 - 2(s + 2)}{(s + 2)^2 + 1}.$$

We find that

$$\mathcal{L}^{-1}\left[\frac{5}{\xi^2 + 1} - \frac{2\xi}{\xi^2 + 1}\right] = 5 \sin t - 2 \cos t.$$

Using the fact that  $\mathcal{L}[e^{at}f(t)] = \mathcal{L}[f(t)]_{s \rightarrow s-a}$ ,

$$\mathcal{L}^{-1}\left[\frac{1 - 2s}{s^2 + 4s + 5}\right] = e^{-2t}(5 \sin t - 2 \cos t).$$

10. Note that the denominator  $s^2 + 2s + 10$  is *irreducible* over the reals. Completing the square,  $s^2 + 2s + 10 = (s + 1)^2 + 9$ . Now convert the function to a *rational function* of the variable  $\xi = s + 1$ . That is,

$$\frac{2s - 3}{s^2 + 2s + 10} = \frac{2(s + 1) - 5}{(s + 1)^2 + 9}.$$

We find that

$$\mathcal{L}^{-1}\left[\frac{2\xi}{\xi^2 + 9} - \frac{5}{\xi^2 + 9}\right] = 2 \cos 3t - \frac{5}{3} \sin 3t.$$

Using the fact that  $\mathcal{L}[e^{at}f(t)] = \mathcal{L}[f(t)]_{s \rightarrow s-a}$ ,

$$\mathcal{L}^{-1}\left[\frac{2s - 3}{s^2 + 2s + 10}\right] = e^{-t}\left(2 \cos 3t - \frac{5}{3} \sin 3t\right).$$

12. Taking the Laplace transform of the ODE, we obtain

$$s^2 Y(s) - s y(0) - y'(0) + 3[s Y(s) - y(0)] + 2 Y(s) = 0.$$

Applying the *initial conditions*,

$$s^2 Y(s) + 3s Y(s) + 2 Y(s) - s - 3 = 0.$$

Solving for  $Y(s)$ , the transform of the solution is

$$Y(s) = \frac{s + 3}{s^2 + 3s + 2}.$$

Using *partial fractions*,

$$\frac{s+3}{s^2+3s+2} = \frac{2}{s+1} - \frac{1}{s+2}.$$

Hence  $y(t) = \mathcal{L}^{-1}[Y(s)] = 2e^{-t} - e^{-2t}$ .

13. Taking the Laplace transform of the ODE, we obtain

$$s^2 Y(s) - s y(0) - y'(0) - 2[s Y(s) - y(0)] + 2 Y(s) = 0.$$

Applying the *initial conditions*,

$$s^2 Y(s) - 2s Y(s) + 2 Y(s) - 1 = 0.$$

Solving for  $Y(s)$ , the transform of the solution is

$$Y(s) = \frac{1}{s^2 - 2s + 2}.$$

Since the denominator is *irreducible*, write the transform as a function of  $\xi = s - 1$ . That is,

$$\frac{1}{s^2 - 2s + 2} = \frac{1}{(s-1)^2 + 1}.$$

First note that

$$\mathcal{L}^{-1}\left[\frac{1}{\xi^2 + 1}\right] = \sin t.$$

Using the fact that  $\mathcal{L}[e^{at}f(t)] = \mathcal{L}[f(t)]_{s \rightarrow s-a}$ ,

$$\mathcal{L}^{-1}\left[\frac{1}{s^2 - 2s + 2}\right] = e^t \sin t.$$

Hence  $y(t) = e^t \sin t$ .

15. Taking the Laplace transform of the ODE, we obtain

$$s^2 Y(s) - s y(0) - y'(0) - 2[s Y(s) - y(0)] - 2 Y(s) = 0.$$

Applying the *initial conditions*,

$$s^2 Y(s) - 2s Y(s) - 2 Y(s) - 2s + 4 = 0.$$

Solving for  $Y(s)$ , the transform of the solution is

$$Y(s) = \frac{2s-4}{s^2-2s-2}.$$

Since the denominator is *irreducible*, write the transform as a function of  $\xi = s - 1$ . Completing the square,

$$\frac{2s - 4}{s^2 - 2s - 2} = \frac{2(s - 1) - 2}{(s - 1)^2 - 3}.$$

First note that

$$\mathcal{L}^{-1} \left[ \frac{2\xi}{\xi^2 - 3} - \frac{2}{\xi^2 - 3} \right] = 2 \cosh \sqrt{3} t - \frac{2}{\sqrt{3}} \sinh \sqrt{3} t.$$

Using the fact that  $\mathcal{L}[e^{at}f(t)] = \mathcal{L}[f(t)]_{s \rightarrow s-a}$ , the solution of the IVP is

$$y(t) = \mathcal{L}^{-1} \left[ \frac{2s - 4}{s^2 - 2s - 2} \right] = e^t \left( 2 \cosh \sqrt{3} t - \frac{2}{\sqrt{3}} \sinh \sqrt{3} t \right).$$

16. Taking the Laplace transform of the ODE, we obtain

$$s^2 Y(s) - s y(0) - y'(0) + 2[s Y(s) - y(0)] + 5 Y(s) = 0.$$

Applying the *initial conditions*,

$$s^2 Y(s) + 2s Y(s) + 5 Y(s) - 2s - 3 = 0.$$

Solving for  $Y(s)$ , the transform of the solution is

$$Y(s) = \frac{2s + 3}{s^2 + 2s + 5}.$$

Since the denominator is *irreducible*, write the transform as a function of  $\xi = s + 1$ . That is,

$$\frac{2s + 3}{s^2 + 2s + 5} = \frac{2(s + 1) + 1}{(s + 1)^2 + 4}.$$

We know that

$$\mathcal{L}^{-1} \left[ \frac{2\xi}{\xi^2 + 4} + \frac{1}{\xi^2 + 4} \right] = 2 \cos 2t + \frac{1}{2} \sin 2t.$$

Using the fact that  $\mathcal{L}[e^{at}f(t)] = \mathcal{L}[f(t)]_{s \rightarrow s-a}$ , the solution of the IVP is

$$y(t) = \mathcal{L}^{-1} \left[ \frac{2s + 3}{s^2 + 2s + 5} \right] = e^{-t} \left( 2 \cos 2t + \frac{1}{2} \sin 2t \right).$$

17. Taking the Laplace transform of the ODE, we obtain

$$s^4 Y(s) - s^3 y(0) - s^2 y'(0) - s y''(0) - y'''(0) - 4[s^3 Y(s) - s^2 y(0) - s y'(0) - y''(0)] + 6[s^2 Y(s) - s y(0) - y'(0)] - 4[s Y(s) - y(0)] + Y(s) = 0$$

Applying the *initial conditions*,

$$s^4 Y(s) - 4s^3 Y(s) + 6s^2 Y(s) - 4s Y(s) + Y(s) - s^2 + 4s - 7 = 0.$$

Solving for the transform of the solution,

$$Y(s) = \frac{s^2 - 4s + 7}{s^4 - 4s^3 + 6s^2 - 4s + 1} = \frac{s^2 - 4s + 7}{(s - 1)^4}.$$

Using *partial fractions*,

$$\frac{s^2 - 4s + 7}{(s - 1)^4} = \frac{4}{(s - 1)^4} - \frac{2}{(s - 1)^3} + \frac{1}{(s - 1)^2}.$$

Note that  $\mathcal{L}[t^n] = (n!)/s^{n+1}$  and  $\mathcal{L}[e^{at} f(t)] = \mathcal{L}[f(t)]_{s \rightarrow s-a}$ . Hence the solution of the IVP is

$$y(t) = \mathcal{L}^{-1} \left[ \frac{s^2 - 4s + 7}{(s - 1)^4} \right] = \frac{2}{3} t^3 e^t - t^2 e^t + t e^t.$$

18. Taking the Laplace transform of the ODE, we obtain

$$s^4 Y(s) - s^3 y(0) - s^2 y'(0) - s y''(0) - y'''(0) - Y(s) = 0.$$

Applying the *initial conditions*,

$$s^4 Y(s) - Y(s) - s^3 - s = 0.$$

Solving for the transform of the solution,

$$Y(s) = \frac{s}{s^2 - 1}.$$

By inspection, it follows that  $y(t) = \mathcal{L}^{-1} \left[ \frac{s}{s^2 - 1} \right] = \cosh t$ .

19. Taking the Laplace transform of the ODE, we obtain

$$s^4 Y(s) - s^3 y(0) - s^2 y'(0) - s y''(0) - y'''(0) - 4Y(s) = 0.$$

Applying the *initial conditions*,

$$s^4 Y(s) - 4Y(s) - s^3 + 2s = 0.$$

Solving for the transform of the solution,

$$Y(s) = \frac{s}{s^2 + 2}.$$

It follows that  $y(t) = \mathcal{L}^{-1} \left[ \frac{s}{s^2 + 2} \right] = \cos \sqrt{2} t$ .

20. Taking the Laplace transform of both sides of the ODE, we obtain

$$s^2 Y(s) - s y(0) - y'(0) + \omega^2 Y(s) = \frac{s}{s^2 + 4}.$$

Applying the *initial conditions*,

$$s^2 Y(s) + \omega^2 Y(s) - s = \frac{s}{s^2 + 4}.$$

Solving for  $Y(s)$ , the transform of the solution is

$$Y(s) = \frac{s}{(s^2 + \omega^2)(s^2 + 4)} + \frac{s}{s^2 + \omega^2}.$$

Using *partial fractions* on the first term,

$$\frac{s}{(s^2 + \omega^2)(s^2 + 4)} = \frac{1}{4 - \omega^2} \left[ \frac{s}{s^2 + \omega^2} - \frac{s}{s^2 + 4} \right].$$

First note that

$$\mathcal{L}^{-1} \left[ \frac{s}{s^2 + \omega^2} \right] = \cos \omega t \quad \text{and} \quad \mathcal{L}^{-1} \left[ \frac{s}{s^2 + 4} \right] = \cos 2t.$$

Hence the solution of the IVP is

$$\begin{aligned} y(t) &= \frac{1}{4 - \omega^2} \cos \omega t - \frac{1}{4 - \omega^2} \cos 2t + \cos \omega t \\ &= \frac{5 - \omega^2}{4 - \omega^2} \cos \omega t - \frac{1}{4 - \omega^2} \cos 2t. \end{aligned}$$

21. Taking the Laplace transform of both sides of the ODE, we obtain

$$s^2 Y(s) - s y(0) - y'(0) - 2[s Y(s) - y(0)] + 2Y(s) = \frac{s}{s^2 + 1}.$$

Applying the *initial conditions*,

$$s^2 Y(s) - 2s Y(s) + 2Y(s) - s + 2 = \frac{s}{s^2 + 1}.$$

Solving for  $Y(s)$ , the transform of the solution is

$$Y(s) = \frac{s}{(s^2 - 2s + 2)(s^2 + 1)} + \frac{s - 2}{s^2 - 2s + 2}.$$

Using *partial fractions* on the first term,

$$\frac{s}{(s^2 - 2s + 2)(s^2 + 1)} = \frac{1}{5} \left[ \frac{s - 2}{s^2 + 1} - \frac{s - 4}{s^2 - 2s + 2} \right].$$

Thus we can write



$$Y(s) = \frac{1}{5} \frac{s}{s^2 + 1} - \frac{2}{5} \frac{1}{s^2 + 1} + \frac{2}{5} \frac{2s - 3}{s^2 - 2s + 2}.$$

For the *last term*, we note that  $s^2 - 2s + 2 = (s - 1)^2 + 1$ . So that

$$\frac{2s - 3}{s^2 - 2s + 2} = \frac{2(s - 1) - 1}{(s - 1)^2 + 1}.$$

We know that

$$\mathcal{L}^{-1} \left[ \frac{2\xi}{\xi^2 + 1} - \frac{1}{\xi^2 + 1} \right] = 2 \cos t - \sin t.$$

Based on the *translation property* of the Laplace transform,

$$\mathcal{L}^{-1} \left[ \frac{2s - 3}{s^2 - 2s + 2} \right] = e^t (2 \cos t - \sin t).$$

Combining the above, the solution of the IVP is

$$y(t) = \frac{1}{5} \cos t - \frac{2}{5} \sin t + \frac{2}{5} e^t (2 \cos t - \sin t).$$

23. Taking the Laplace transform of both sides of the ODE, we obtain

$$s^2 Y(s) - s y(0) - y'(0) + 2[s Y(s) - y(0)] + Y(s) = \frac{4}{s + 1}.$$

Applying the *initial conditions*,

$$s^2 Y(s) + 2s Y(s) + Y(s) - 2s - 3 = \frac{4}{s + 1}.$$

Solving for  $Y(s)$ , the transform of the solution is

$$Y(s) = \frac{4}{(s + 1)^3} + \frac{2s + 3}{(s + 1)^2}.$$

First write

$$\frac{2s + 3}{(s + 1)^2} = \frac{2(s + 1) + 1}{(s + 1)^2} = \frac{2}{s + 1} + \frac{1}{(s + 1)^2}.$$

We note that

$$\mathcal{L}^{-1} \left[ \frac{4}{\xi^3} + \frac{2}{\xi} + \frac{1}{\xi^2} \right] = 2t^2 + 2 + t.$$

So based on the *translation property* of the Laplace transform, the solution of the IVP is

$$y(t) = 2t^2e^{-t} + te^{-t} + 2e^{-t}.$$

25. Let  $f(t)$  be the *forcing function* on the right-hand-side. Taking the Laplace transform

of both sides of the ODE, we obtain

$$s^2 Y(s) - sy(0) - y'(0) + Y(s) = \mathcal{L}[f(t)].$$

Applying the *initial conditions*,

$$s^2 Y(s) + Y(s) = \mathcal{L}[f(t)].$$

Based on the definition of the Laplace transform,

$$\begin{aligned} \mathcal{L}[f(t)] &= \int_0^{\infty} f(t) e^{-st} dt \\ &= \int_0^1 t e^{-st} dt \\ &= \frac{1}{s^2} - \frac{e^{-s}}{s} - \frac{e^{-s}}{s^2}. \end{aligned}$$

Solving for the transform,

$$Y(s) = \frac{1}{s^2(s^2 + 1)} - e^{-s} \frac{s + 1}{s^2(s^2 + 1)}.$$

Using *partial fractions*,

$$\frac{1}{s^2(s^2 + 1)} = \frac{1}{s^2} - \frac{1}{s^2 + 1}$$

and

$$\frac{s}{s^2(s^2 + 1)} = \frac{1}{s} - \frac{s}{s^2 + 1}.$$

We find, by inspection, that

$$\mathcal{L}^{-1} \left[ \frac{1}{s^2(s^2 + 1)} \right] = t - \sin t.$$

Referring to *Line 13*, in Table 6.2.1,

$$\mathcal{L}[u_c(t)f(t - c)] = e^{-cs} \mathcal{L}[f(t)].$$

Let

$$\mathcal{L}[g(t)] = \frac{s + 1}{s^2(s^2 + 1)} = \frac{1}{s} + \frac{1}{s^2} - \frac{s}{s^2 + 1} - \frac{1}{s^2 + 1}.$$

Then  $g(t) = 1 + t - \cos t - \sin t$ . It follows, therefore, that

$$\mathcal{L}^{-1}\left[e^{-s} \cdot \frac{s+1}{s^2(s^2+1)}\right] = u_1(t)[1 + (t-1) - \cos(t-1) - \sin(t-1)].$$

Combining the above, the solution of the IVP is

$$y(t) = t - \sin t - u_1(t)[1 + (t-1) - \cos(t-1) - \sin(t-1)].$$

26. Let  $f(t)$  be the *forcing function* on the right-hand-side. Taking the Laplace transform

of both sides of the ODE, we obtain

$$s^2 Y(s) - s y(0) - y'(0) + 4 Y(s) = \mathcal{L}[f(t)].$$

Applying the *initial conditions*,

$$s^2 Y(s) + 4 Y(s) = \mathcal{L}[f(t)].$$

Based on the definition of the Laplace transform,

$$\begin{aligned} \mathcal{L}[f(t)] &= \int_0^{\infty} f(t) e^{-st} dt \\ &= \int_0^1 t e^{-st} dt + \int_1^{\infty} e^{-st} dt \\ &= \frac{1}{s^2} - \frac{e^{-s}}{s^2}. \end{aligned}$$

Solving for the transform,

$$Y(s) = \frac{1}{s^2(s^2+4)} - e^{-s} \frac{1}{s^2(s^2+4)}.$$

Using *partial fractions*,

$$\frac{1}{s^2(s^2+4)} = \frac{1}{4} \left[ \frac{1}{s^2} - \frac{1}{s^2+4} \right].$$

We find that

$$\mathcal{L}^{-1}\left[\frac{1}{s^2(s^2+4)}\right] = \frac{1}{4}t - \frac{1}{8}\sin t.$$

Referring to *Line 13*, in Table 6.2.1,

$$\mathcal{L}[u_c(t)f(t-c)] = e^{-cs}\mathcal{L}[f(t)].$$

It follows that

$$\mathcal{L}^{-1}\left[e^{-s} \cdot \frac{1}{s^2(s^2+4)}\right] = u_1(t) \left[ \frac{1}{4}(t-1) - \frac{1}{8} \sin(t-1) \right].$$

Combining the above, the solution of the IVP is

$$y(t) = \frac{1}{4}t - \frac{1}{8} \sin t - u_1(t) \left[ \frac{1}{4}(t-1) - \frac{1}{8} \sin(t-1) \right].$$

28(a). Assuming that the conditions of Theorem 6.2.1 are satisfied,

$$\begin{aligned} F'(s) &= \frac{d}{ds} \int_0^{\infty} e^{-st} f(t) dt \\ &= \int_0^{\infty} \frac{\partial}{\partial s} [e^{-st} f(t)] dt \\ &= \int_0^{\infty} [-t e^{-st} f(t)] dt \\ &= \int_0^{\infty} e^{-st} [-t f(t)] dt. \end{aligned}$$

(b). Using *mathematical induction*, suppose that for some  $k \geq 1$ ,

$$F^{(k)}(s) = \int_0^{\infty} e^{-st} [(-t)^k f(t)] dt.$$

Differentiating both sides,

$$\begin{aligned} F^{(k+1)}(s) &= \frac{d}{ds} \int_0^{\infty} e^{-st} [(-t)^k f(t)] dt \\ &= \int_0^{\infty} \frac{\partial}{\partial s} [e^{-st} (-t)^k f(t)] dt \\ &= \int_0^{\infty} [-t e^{-st} (-t)^k f(t)] dt \\ &= \int_0^{\infty} e^{-st} [(-t)^{k+1} f(t)] dt. \end{aligned}$$

29. We know that

$$\mathcal{L}[e^{at}] = \frac{1}{s-a}.$$

Based on Prob. 28,

$$\mathcal{L}[-t e^{at}] = \frac{d}{ds} \left[ \frac{1}{s-a} \right].$$

Therefore,

$$\mathcal{L}[t e^{at}] = \frac{1}{(s-a)^2}.$$

31. Based on Prob. 28,

$$\begin{aligned} \mathcal{L}[(-t)^n] &= \frac{d^n}{ds^n} \mathcal{L}[1] \\ &= \frac{d^n}{ds^n} \left[ \frac{1}{s} \right]. \end{aligned}$$

Therefore,

$$\begin{aligned} \mathcal{L}[t^n] &= (-1)^n \frac{(-1)^n n!}{s^{n+1}} \\ &= \frac{n!}{s^{n+1}}. \end{aligned}$$

33. Using the *translation property* of the Laplace transform,

$$\mathcal{L}[e^{at} \sin bt] = \frac{b}{(s-a)^2 + b^2}.$$

Therefore,

$$\begin{aligned} \mathcal{L}[t e^{at} \sin bt] &= -\frac{d}{ds} \left[ \frac{b}{(s-a)^2 + b^2} \right] \\ &= \frac{2b(s-a)}{(s^2 - 2as + a^2 + b^2)^2}. \end{aligned}$$

34. Using the *translation property* of the Laplace transform,

$$\mathcal{L}[e^{at} \cos bt] = \frac{s-a}{(s-a)^2 + b^2}.$$

Therefore,

$$\begin{aligned} \mathcal{L}[t e^{at} \cos bt] &= -\frac{d}{ds} \left[ \frac{s-a}{(s-a)^2 + b^2} \right] \\ &= \frac{(s-a)^2 - b^2}{(s^2 - 2as + a^2 + b^2)^2}. \end{aligned}$$

35(a). Taking the Laplace transform of the given *Bessel equation*,

$$\mathcal{L}[ty''] + \mathcal{L}[y'] + \mathcal{L}[ty] = 0.$$

Using the *differentiation property* of the transform,

$$-\frac{d}{ds}\mathcal{L}[y''] + \mathcal{L}[y'] - \frac{d}{ds}\mathcal{L}[y] = 0.$$

That is,

$$-\frac{d}{ds}[s^2Y(s) - sy(0) - y'(0)] + sY(s) - y(0) - \frac{d}{ds}Y(s) = 0.$$

It follows that

$$(1 + s^2)Y'(s) + sY(s) = 0.$$

(b). We obtain a *first-order linear* ODE in  $Y(s)$ :

$$Y'(s) + \frac{s}{s^2 + 1}Y(s) = 0,$$

with *integrating factor*

$$\mu(s) = \exp\left(\int \frac{s}{s^2 + 1} ds\right) = \sqrt{s^2 + 1}.$$

The first-order ODE can be written as

$$\frac{d}{ds}[\sqrt{s^2 + 1} \cdot Y(s)] = 0,$$

with solution

$$Y(s) = \frac{c}{\sqrt{s^2 + 1}}.$$

(c). In order to obtain *negative* powers of  $s$ , first write

$$\frac{1}{\sqrt{s^2 + 1}} = \frac{1}{s} \left[1 + \frac{1}{s^2}\right]^{-1/2}.$$

Expanding  $\left(1 + \frac{1}{s^2}\right)^{-1/2}$  in a *binomial series*,

$$\frac{1}{\sqrt{1 + (1/s^2)}} = 1 - \frac{1}{2}s^{-2} + \frac{1 \cdot 3}{2 \cdot 4}s^{-4} - \frac{1 \cdot 3 \cdot 5}{2 \cdot 4 \cdot 6}s^{-6} + \dots,$$

valid for  $s^{-2} < 1$ . Hence, we can formally express  $Y(s)$  as

$$Y(s) = c \left[ \frac{1}{s} - \frac{1}{2} \frac{1}{s^3} + \frac{1 \cdot 3}{2 \cdot 4} \frac{1}{s^5} - \frac{1 \cdot 3 \cdot 5}{2 \cdot 4 \cdot 6} \frac{1}{s^7} + \dots \right].$$

Assuming that *term-by-term* inversion is valid,

$$\begin{aligned} y(t) &= c \left[ 1 - \frac{1}{2} \frac{t^2}{2!} + \frac{1 \cdot 3}{2 \cdot 4} \frac{t^4}{4!} - \frac{1 \cdot 3 \cdot 5}{2 \cdot 4 \cdot 6} \frac{t^6}{6!} + \dots \right] \\ &= c \left[ 1 - \frac{2!}{2^2} \frac{t^2}{2!} + \frac{4!}{2^2 \cdot 4^2} \frac{t^4}{4!} - \frac{6!}{2^2 \cdot 4^2 \cdot 6^2} \frac{t^6}{6!} + \dots \right]. \end{aligned}$$

It follows that

$$\begin{aligned} y(t) &= c \left[ 1 - \frac{1}{2^2} t^2 + \frac{1}{2^2 \cdot 4^2} t^4 - \frac{1}{2^2 \cdot 4^2 \cdot 6^2} t^6 + \dots \right] \\ &= c \sum_{n=0}^{\infty} \frac{(-1)^n}{2^{2n} (n!)^2} t^{2n}. \end{aligned}$$

The series is evidently the expansion, about  $x = 0$ , of  $J_0(t)$ .

36(b). Taking the Laplace transform of the given *Legendre equation*,

$$\mathcal{L}[y''] - \mathcal{L}[t^2 y''] - 2\mathcal{L}[t y'] + \alpha(\alpha + 1)\mathcal{L}[y] = 0.$$

Using the *differentiation property* of the transform,

$$\mathcal{L}[y''] - \frac{d^2}{ds^2} \mathcal{L}[y''] + 2 \frac{d}{ds} \mathcal{L}[y'] + \alpha(\alpha + 1)\mathcal{L}[y] = 0.$$

That is,

$$\begin{aligned} [s^2 Y(s) - s y(0) - y'(0)] - \frac{d^2}{ds^2} [s^2 Y(s) - s y(0) - y'(0)] + \\ + 2 \frac{d}{ds} [s Y(s) - y(0)] + \alpha(\alpha + 1)Y(s) = 0. \end{aligned}$$

Invoking the *initial conditions*, we have

$$s^2 Y(s) - 1 - \frac{d^2}{ds^2} [s^2 Y(s) - 1] + 2 \frac{d}{ds} [s Y(s)] + \alpha(\alpha + 1)Y(s) = 0.$$

After carrying out the differentiation, the equation simplifies to

$$\frac{d^2}{ds^2} [s^2 Y(s)] - 2 \frac{d}{ds} [s Y(s)] - [s^2 + \alpha(\alpha + 1)]Y(s) = -1.$$

That is,

$$s^2 \frac{d^2}{ds^2} Y(s) + 2s \frac{d}{ds} Y(s) - [s^2 + \alpha(\alpha + 1)]Y(s) = -1.$$

37. By definition of the Laplace transform, given the appropriate conditions,

$$\begin{aligned}\mathcal{L}[g(t)] &= \int_0^{\infty} e^{-st} \left[ \int_0^t f(\tau) d\tau \right] dt \\ &= \int_0^{\infty} \int_0^t e^{-st} f(\tau) d\tau dt.\end{aligned}$$

Assuming that the order of integration can be exchanged,

$$\begin{aligned}\mathcal{L}[g(t)] &= \int_0^{\infty} f(\tau) \left[ \int_{\tau}^{\infty} e^{-st} dt \right] d\tau \\ &= \int_0^{\infty} f(\tau) \left[ \frac{e^{-s\tau}}{s} \right] d\tau.\end{aligned}$$

[Note the *region* of integration is the area between the lines  $\tau(t) = t$  and  $\tau(t) = 0$ .]  
Hence

$$\begin{aligned}\mathcal{L}[g(t)] &= \frac{1}{s} \int_0^{\infty} f(\tau) e^{-s\tau} d\tau \\ &= \frac{1}{s} \mathcal{L}[f(t)].\end{aligned}$$



**Section 6.3**

1.

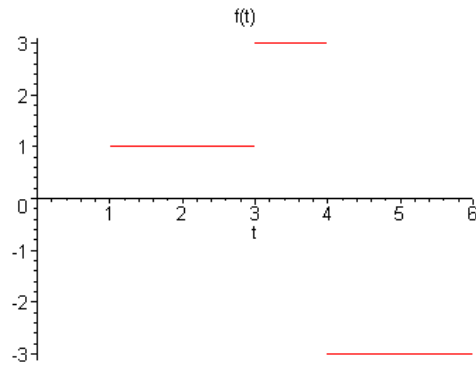

3.

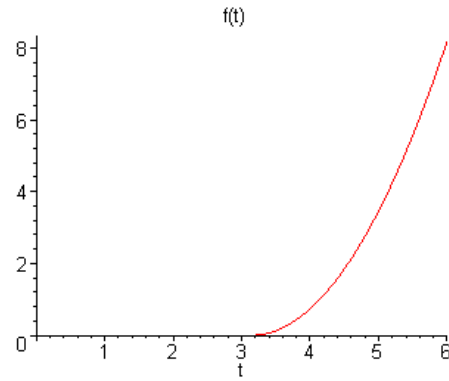

5.

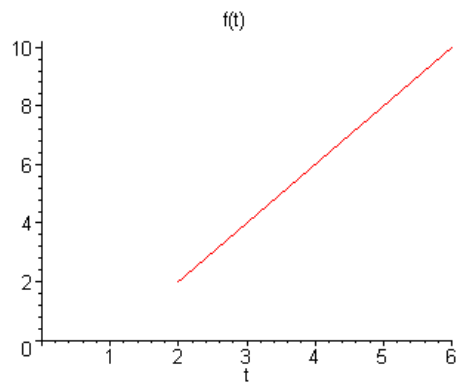

6.

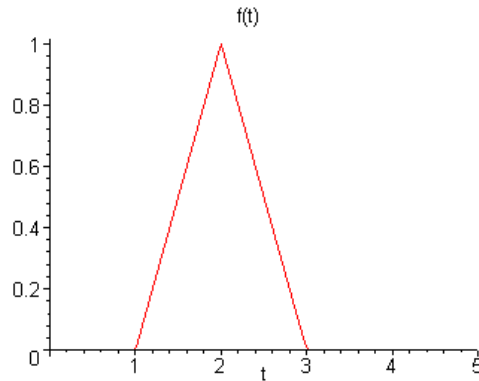

7. Using the Heaviside function, we can write

$$f(t) = (t - 2)^2 u_2(t).$$

The Laplace transform has the property that

$$\mathcal{L}[u_c(t)f(t - c)] = e^{-cs} \mathcal{L}[f(t)].$$

Hence

$$\mathcal{L}[(t - 2)^2 u_2(t)] = \frac{2e^{-2s}}{s^2}.$$

9. The function can be expressed as

$$f(t) = (t - \pi)[u_\pi(t) - u_{2\pi}(t)].$$

Before invoking the *translation property* of the transform, write the function as

$$f(t) = (t - \pi) u_\pi(t) - (t - 2\pi) u_{2\pi}(t) - \pi u_{2\pi}(t).$$

It follows that

$$\mathcal{L}[f(t)] = \frac{e^{-\pi s}}{s^2} - \frac{e^{-2\pi s}}{s^2} - \frac{\pi e^{-2\pi s}}{s}.$$

10. It follows directly from the *translation property* of the transform that

$$\mathcal{L}[f(t)] = \frac{e^{-s}}{s} + 2\frac{e^{-3s}}{s} - 6\frac{e^{-4s}}{s}.$$

11. Before invoking the *translation property* of the transform, write the function as

$$f(t) = (t - 2) u_2(t) - u_2(t) - (t - 3) u_3(t) - u_3(t).$$

It follows that

$$\mathcal{L}[f(t)] = \frac{e^{-2s}}{s^2} - \frac{e^{-2s}}{s} - \frac{e^{-3s}}{s^2} - \frac{e^{-3s}}{s}.$$

12. It follows directly from the *translation property* of the transform that

$$\mathcal{L}[f(t)] = \frac{1}{s^2} - \frac{e^{-s}}{s^2}.$$

13. Using the fact that  $\mathcal{L}[e^{at}f(t)] = \mathcal{L}[f(t)]_{s \rightarrow s-a}$ ,

$$\mathcal{L}^{-1}\left[\frac{3!}{(s-2)^4}\right] = t^3 e^{2t}.$$

15. First consider the function

$$G(s) = \frac{2(s-1)}{s^2 - 2s + 2}.$$

Completing the square in the denominator,

$$G(s) = \frac{2(s-1)}{(s-1)^2 + 1}.$$

It follows that

$$\mathcal{L}^{-1}[G(s)] = 2e^t \cos t.$$

Hence

$$\mathcal{L}^{-1}[e^{-2s}G(s)] = 2e^{(t-2)} \cos(t-2) u_2(t).$$

16. The *inverse transform* of the function  $2/(s^2 - 4)$  is  $f(t) = \sinh 2t$ . Using the *translation property* of the transform,

$$\mathcal{L}^{-1}\left[\frac{2e^{-2s}}{s^2 - 4}\right] = \sinh 2(t-2) \cdot u_2(t).$$

17. First consider the function

$$G(s) = \frac{(s-2)}{s^2 - 4s + 3}.$$

Completing the square in the denominator,

$$G(s) = \frac{(s-2)}{(s-2)^2 - 1}.$$

It follows that

$$\mathcal{L}^{-1}[G(s)] = e^{2t} \cosh t.$$

Hence

$$\mathcal{L}^{-1}\left[\frac{(s-2)e^{-s}}{s^2 - 4s + 3}\right] = e^{2(t-1)} \cosh(t-1) u_1(t).$$

18. Write the function as

$$F(s) = \frac{e^{-s}}{s} + \frac{e^{-2s}}{s} - \frac{e^{-3s}}{s} - \frac{e^{-4s}}{s}.$$

It follows from the *translation property* of the transform, that

$$\mathcal{L}^{-1}\left[\frac{e^{-s} + e^{-2s} - e^{-3s} - e^{-4s}}{s}\right] = u_1(t) + u_2(t) - u_3(t) - u_4(t).$$

19(a). By definition of the Laplace transform,

$$\mathcal{L}[f(ct)] = \int_0^{\infty} e^{-st} f(ct) dt.$$

Making a change of variable,  $\tau = ct$ , we have

$$\begin{aligned} \mathcal{L}[f(ct)] &= \frac{1}{c} \int_0^{\infty} e^{-s(\tau/c)} f(\tau) d\tau \\ &= \frac{1}{c} \int_0^{\infty} e^{-(s/c)\tau} f(\tau) d\tau. \end{aligned}$$

Hence  $\mathcal{L}[f(ct)] = \frac{1}{c} F\left(\frac{s}{c}\right)$ , where  $s/c > a$ .

(b). Using the result in Part (a),

$$\mathcal{L}\left[f\left(\frac{t}{k}\right)\right] = k F(ks).$$

Hence

$$\mathcal{L}^{-1}[F(ks)] = \frac{1}{k} f\left(\frac{t}{k}\right).$$

(c). From Part (b),

$$\mathcal{L}^{-1}[F(as)] = \frac{1}{a} f\left(\frac{t}{a}\right).$$

Note that  $as + b = a(s + b/a)$ . Using the fact that  $\mathcal{L}[e^{ct}f(t)] = \mathcal{L}[f(t)]_{s \rightarrow s-c}$ ,

$$\mathcal{L}^{-1}[F(as + b)] = e^{-bt/a} \frac{1}{a} f\left(\frac{t}{a}\right).$$

20. First write

$$F(s) = \frac{n!}{\left(\frac{s}{2}\right)^{n+1}}.$$

Let  $G(s) = n!/s^{n+1}$ . Based on the results in Prob. 19,

$$\frac{1}{2} \mathcal{L}^{-1}\left[G\left(\frac{s}{2}\right)\right] = g(2t),$$

in which  $g(t) = t^n$ . Hence

$$\mathcal{L}^{-1}[F(s)] = 2(2t)^n = 2^{n+1}t^n.$$

23. First write

$$F(s) = \frac{e^{-4(s-1/2)}}{2(s-1/2)}.$$

Now consider

$$G(s) = \frac{e^{-2s}}{s}.$$

Using the result in Prob. 19(b),

$$\mathcal{L}^{-1}[G(2s)] = \frac{1}{2} g\left(\frac{t}{2}\right),$$

in which  $g(t) = u_2(t)$ . Hence  $\mathcal{L}^{-1}[G(2s)] = \frac{1}{2} u_2(t/2) = \frac{1}{2} u_4(t)$ . It follows that

$$\mathcal{L}^{-1}[F(s)] = \frac{1}{2} e^{t/2} u_4(t).$$

24. By definition of the Laplace transform,

$$\mathcal{L}[f(t)] = \int_0^{\infty} e^{-st} u_1(t) dt.$$

That is,

$$\begin{aligned} \mathcal{L}[f(t)] &= \int_0^1 e^{-st} dt \\ &= \frac{1 - e^{-s}}{s}. \end{aligned}$$

25. First write the function as  $f(t) = u_0(t) - u_1(t) + u_2(t) - u_3(t)$ . It follows that

$$\mathcal{L}[f(t)] = \int_0^1 e^{-st} dt + \int_2^3 e^{-st} dt.$$

That is,

$$\begin{aligned} \mathcal{L}[f(t)] &= \frac{1 - e^{-s}}{s} + \frac{e^{-2s} - e^{-3s}}{s} \\ &= \frac{1 - e^{-s} + e^{-2s} - e^{-3s}}{s}. \end{aligned}$$

26. The transform may be computed directly. On the other hand, using the *translation property* of the transform,

$$\begin{aligned} \mathcal{L}[f(t)] &= \frac{1}{s} + \sum_{k=1}^{2n+1} (-1)^k \frac{e^{-ks}}{s} \\ &= \frac{1}{s} \left[ \sum_{k=0}^{2n+1} (-e^{-s})^k \right] \\ &= \frac{1}{s} \frac{1 - (-e^{-s})^{2n+2}}{1 + e^{-s}}. \end{aligned}$$

That is,

$$\mathcal{L}[f(t)] = \frac{1 - (e^{-2s})^{n+1}}{s(1 + e^{-s})}.$$

29. The given function is *periodic*, with  $T = 2$ . Using the result of Prob. 28,

$$\mathcal{L}[f(t)] = \frac{1}{1 - e^{-2s}} \int_0^2 e^{-st} f(t) dt = \frac{1}{1 - e^{-2s}} \int_0^1 e^{-st} dt.$$

That is,

$$\begin{aligned}\mathcal{L}[f(t)] &= \frac{1 - e^{-s}}{s(1 - e^{-2s})} \\ &= \frac{1}{s(1 + e^{-s})}.\end{aligned}$$

31. The function is *periodic*, with  $T = 1$ . Using the result of Prob. 28,

$$\mathcal{L}[f(t)] = \frac{1}{1 - e^{-s}} \int_0^1 t e^{-st} dt.$$

It follows that

$$\mathcal{L}[f(t)] = \frac{1 - e^{-s}(1 + s)}{s^2(1 - e^{-s})}.$$

32. The function is *periodic*, with  $T = \pi$ . Using the result of Prob. 28,

$$\mathcal{L}[f(t)] = \frac{1}{1 - e^{-\pi s}} \int_0^\pi \sin t \cdot e^{-st} dt.$$

We first calculate

$$\int_0^\pi \sin t \cdot e^{-st} dt = \frac{1 + e^{-\pi s}}{1 + s^2}.$$

Hence

$$\mathcal{L}[f(t)] = \frac{1 + e^{-\pi s}}{(1 - e^{-\pi s})(1 + s^2)}.$$

33(a).

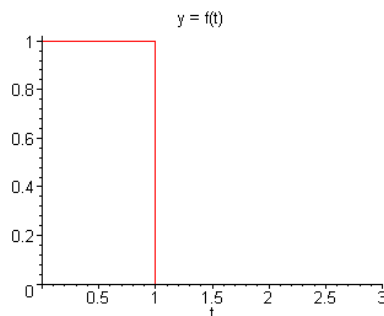

$$\begin{aligned}\mathcal{L}[f(t)] &= \mathcal{L}[1] - \mathcal{L}[u_1(t)] \\ &= \frac{1}{s} - \frac{e^{-s}}{s}.\end{aligned}$$

(b).

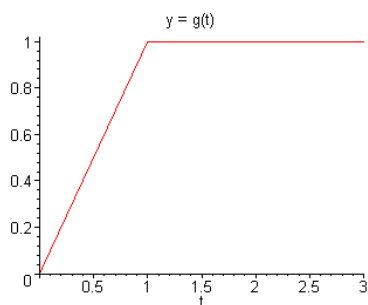

Let  $F(s) = \mathcal{L}[1 - u_1(t)]$ . Then

$$\mathcal{L}\left[\int_0^t [1 - u_1(\tau)] d\tau\right] = \frac{1}{s} F(s) = \frac{1 - e^{-s}}{s^2}.$$

(c).

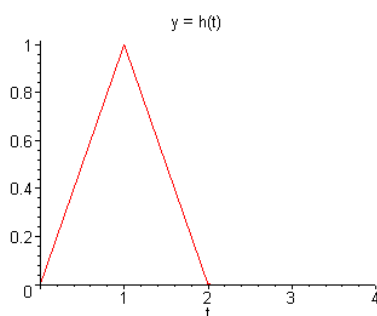

Let  $G(s) = \mathcal{L}[g(t)]$ . Then

$$\begin{aligned} \mathcal{L}[h(t)] &= G(s) - e^{-s} G(s) \\ &= \frac{1 - e^{-s}}{s^2} - e^{-s} \frac{1 - e^{-s}}{s^2} \\ &= \frac{(1 - e^{-s})^2}{s^2}. \end{aligned}$$



34(a).

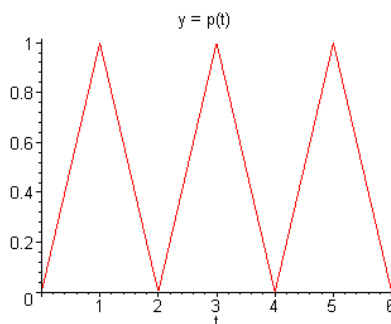

(b). The given function is *periodic*, with  $T = 2$ . Using the result of Prob. 28,

$$\mathcal{L}[f(t)] = \frac{1}{1 - e^{-2s}} \int_0^2 e^{-st} p(t) dt.$$

Based on the piecewise definition of  $p(t)$ ,

$$\begin{aligned} \int_0^2 e^{-st} p(t) dt &= \int_0^1 t e^{-st} dt + \int_1^2 (2-t) e^{-st} dt \\ &= \frac{1}{s^2} (1 - e^{-s})^2. \end{aligned}$$

Hence

$$\mathcal{L}[p(t)] = \frac{(1 - e^{-s})}{s^2(1 + e^{-s})}.$$

(c). Since  $p(t)$  satisfies the hypotheses of Theorem 6.2.1,

$$\mathcal{L}[p'(t)] = s \mathcal{L}[p(t)] - p(0).$$

Using the result of Prob. 30,

$$\mathcal{L}[p'(t)] = \frac{(1 - e^{-s})}{s(1 + e^{-s})}.$$

We note the  $p(0) = 0$ , hence

$$\mathcal{L}[p(t)] = \frac{1}{s} \left[ \frac{(1 - e^{-s})}{s(1 + e^{-s})} \right].$$

### Section 6.4

2. Let  $h(t)$  be the *forcing function* on the right-hand-side. Taking the Laplace transform of both sides of the ODE, we obtain

$$s^2 Y(s) - s y(0) - y'(0) + 2[s Y(s) - y(0)] + 2 Y(s) = \mathcal{L}[h(t)].$$

Applying the initial conditions,

$$s^2 Y(s) + 2s Y(s) + 2 Y(s) - 1 = \mathcal{L}[h(t)].$$

The forcing function can be written as  $h(t) = u_\pi(t) - u_{2\pi}(t)$ . Its transform is

$$\mathcal{L}[h(t)] = \frac{e^{-\pi s} - e^{-2\pi s}}{s}.$$

Solving for  $Y(s)$ , the transform of the solution is

$$Y(s) = \frac{1}{s^2 + 2s + 2} + \frac{e^{-\pi s} - e^{-2\pi s}}{s(s^2 + 2s + 2)}.$$

First note that

$$\frac{1}{s^2 + 2s + 2} = \frac{1}{(s + 1)^2 + 1}.$$

Using partial fractions,

$$\frac{1}{s(s^2 + 2s + 2)} = \frac{1}{2} \frac{1}{s} - \frac{1}{2} \frac{(s + 1) + 1}{(s + 1)^2 + 1}.$$

Taking the inverse transform, term-by-term,

$$\mathcal{L}^{-1}\left[\frac{1}{s^2 + 2s + 2}\right] = \mathcal{L}^{-1}\left[\frac{1}{(s + 1)^2 + 1}\right] = e^{-t} \sin t.$$

Now let

$$G(s) = \frac{1}{s(s^2 + 2s + 2)}.$$

Then

$$\mathcal{L}^{-1}[G(s)] = \frac{1}{2} - \frac{1}{2} e^{-t} \cos t - \frac{1}{2} e^{-t} \sin t.$$

Using Theorem 6.3.1,

$$\mathcal{L}^{-1}[e^{-cs} G(s)] = \frac{1}{2} u_c(t) - \frac{1}{2} e^{-(t-c)} [\cos(t-c) + \sin(t-c)] u_c(t).$$

Hence the solution of the IVP is

$$y(t) = e^{-t} \sin t + \frac{1}{2} u_{\pi}(t) - \frac{1}{2} e^{-(t-\pi)} [\cos(t-\pi) + \sin(t-\pi)] u_{\pi}(t) - \frac{1}{2} u_{2\pi}(t) + \frac{1}{2} e^{-(t-2\pi)} [\cos(t-2\pi) + \sin(t-2\pi)] u_{2\pi}(t).$$

That is,

$$y(t) = e^{-t} \sin t + \frac{1}{2} [u_{\pi}(t) - u_{2\pi}(t)] + \frac{1}{2} e^{-(t-\pi)} [\cos t + \sin t] u_{\pi}(t) + \frac{1}{2} e^{-(t-2\pi)} [\cos t + \sin t] u_{2\pi}(t).$$

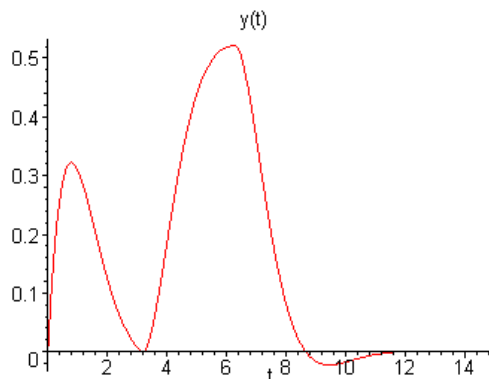
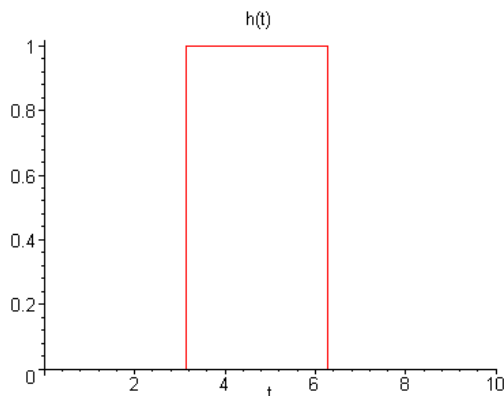

The solution starts out as free oscillation, due to the initial conditions. The amplitude increases, as long as the forcing is present. Thereafter, the solution rapidly decays.

4. Let  $h(t)$  be the *forcing function* on the right-hand-side. Taking the Laplace transform of both sides of the ODE, we obtain

$$s^2 Y(s) - s y(0) - y'(0) + 4Y(s) = \mathcal{L}[h(t)].$$

Applying the initial conditions,

$$s^2 Y(s) + 4Y(s) = \mathcal{L}[h(t)].$$

The transform of the forcing function is

$$\mathcal{L}[h(t)] = \frac{1}{s^2 + 1} + \frac{e^{-\pi s}}{s^2 + 1}.$$

Solving for  $Y(s)$ , the transform of the solution is

$$Y(s) = \frac{1}{(s^2 + 4)(s^2 + 1)} + \frac{e^{-\pi s}}{(s^2 + 4)(s^2 + 1)}.$$

Using partial fractions,

$$\frac{1}{(s^2 + 4)(s^2 + 1)} = \frac{1}{3} \left[ \frac{1}{s^2 + 1} - \frac{1}{s^2 + 4} \right].$$

It follows that

$$\mathcal{L}^{-1} \left[ \frac{1}{(s^2 + 4)(s^2 + 1)} \right] = \frac{1}{3} \left[ \sin t - \frac{1}{2} \sin 2t \right].$$

Based on Theorem 6.3.1,

$$\mathcal{L}^{-1} \left[ \frac{e^{-\pi s}}{(s^2 + 4)(s^2 + 1)} \right] = \frac{1}{3} \left[ \sin(t - \pi) - \frac{1}{2} \sin(2t - 2\pi) \right] u_\pi(t).$$

Hence the solution of the IVP is

$$y(t) = \frac{1}{3} \left[ \sin t - \frac{1}{2} \sin 2t \right] - \frac{1}{3} \left[ \sin t + \frac{1}{2} \sin 2t \right] u_\pi(t).$$

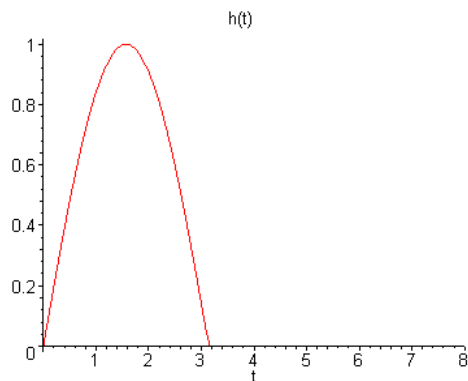

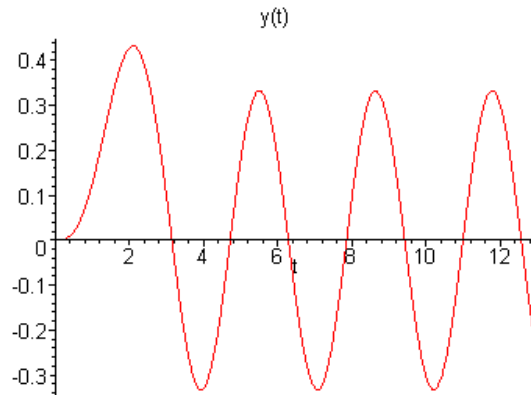

Since there is no *damping term*, the solution follows the forcing function, after which the response is a steady oscillation about  $y = 0$ .

5. Let  $f(t)$  be the *forcing function* on the right-hand-side. Taking the Laplace transform of both sides of the ODE, we obtain

$$s^2 Y(s) - s y(0) - y'(0) + 3[s Y(s) - y(0)] + 2 Y(s) = \mathcal{L}[f(t)].$$

Applying the initial conditions,

$$s^2 Y(s) + 3s Y(s) + 2 Y(s) = \mathcal{L}[f(t)].$$

The transform of the forcing function is

$$\mathcal{L}[f(t)] = \frac{1}{s} - \frac{e^{-10s}}{s}.$$

Solving for the transform,

$$Y(s) = \frac{1}{s(s^2 + 3s + 2)} - \frac{e^{-10s}}{s(s^2 + 3s + 2)}.$$

Using partial fractions,

$$\frac{1}{s(s^2 + 3s + 2)} = \frac{1}{2} \left[ \frac{1}{s} + \frac{1}{s+2} - \frac{2}{s+1} \right].$$

Hence

$$\mathcal{L}^{-1} \left[ \frac{1}{s(s^2 + 3s + 2)} \right] = \frac{1}{2} + \frac{e^{-2t}}{2} - e^{-t}.$$

Based on Theorem 6.3.1,

$$\mathcal{L}^{-1} \left[ \frac{e^{-10s}}{s(s^2 + 3s + 2)} \right] = \frac{1}{2} [1 + e^{-2(t-10)} - 2e^{-(t-10)}] u_{10}(t).$$

Hence the solution of the IVP is

$$y(t) = \frac{1}{2}[1 - u_{10}(t)] + \frac{e^{-2t}}{2} - e^{-t} - \frac{1}{2}[e^{-(2t-20)} - 2e^{-(t-10)}]u_{10}(t).$$

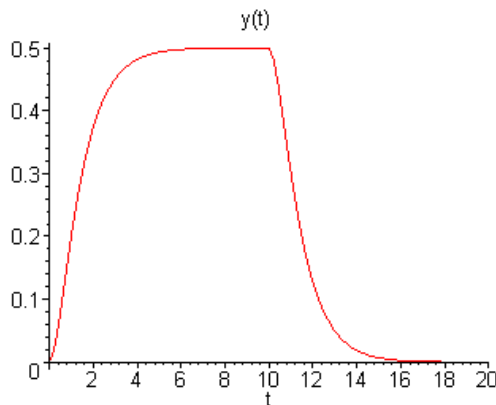
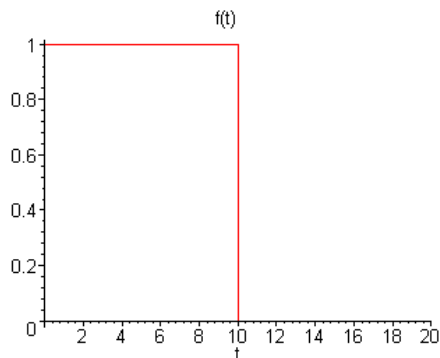

The solution increases to a *temporary* steady value of  $y = 1/2$ . After the forcing ceases, the response decays exponentially to  $y = 0$ .

6. Taking the Laplace transform of both sides of the ODE, we obtain

$$s^2 Y(s) - s y(0) - y'(0) + 3[s Y(s) - y(0)] + 2 Y(s) = \frac{e^{-2s}}{s}.$$

Applying the initial conditions,

$$s^2 Y(s) + 3s Y(s) + 2 Y(s) - 1 = \frac{e^{-2s}}{s}.$$

Solving for the transform,

$$Y(s) = \frac{1}{s^2 + 3s + 2} + \frac{e^{-2s}}{s(s^2 + 3s + 2)}.$$

Using partial fractions,

$$\frac{1}{s^2 + 3s + 2} = \frac{1}{s + 1} - \frac{1}{s + 2}$$

and

$$\frac{1}{s(s^2 + 3s + 2)} = \frac{1}{2} \left[ \frac{1}{s} + \frac{1}{s + 2} - \frac{2}{s + 1} \right].$$

Taking the inverse transform, term-by-term, the solution of the IVP is

$$y(t) = e^{-t} - e^{-2t} + \left[ \frac{1}{2} - e^{-(t-2)} + \frac{1}{2}e^{-2(t-2)} \right] u_2(t).$$

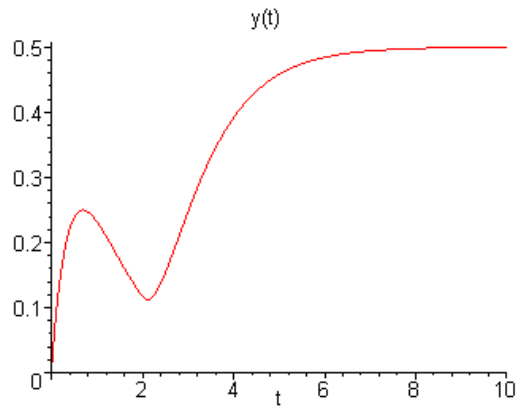
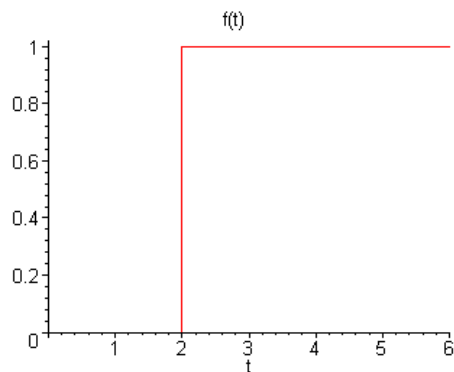

Due to the initial conditions, the response has a transient *overshoot*, followed by an exponential convergence to a steady value of  $y_s = 1/2$ .

7. Taking the Laplace transform of both sides of the ODE, we obtain

$$s^2 Y(s) - s y(0) - y'(0) + Y(s) = \frac{e^{-3\pi s}}{s}.$$

Applying the initial conditions,

$$s^2 Y(s) + Y(s) - s = \frac{e^{-3\pi s}}{s}.$$

Solving for the transform,

$$Y(s) = \frac{s}{s^2 + 1} + \frac{e^{-3\pi s}}{s(s^2 + 1)}.$$

Using partial fractions,

$$\frac{1}{s(s^2 + 1)} = \frac{1}{s} - \frac{s}{s^2 + 1}.$$

Hence

$$Y(s) = \frac{s}{s^2 + 1} + e^{-3\pi s} \left[ \frac{1}{s} - \frac{s}{s^2 + 1} \right].$$

Taking the inverse transform, the solution of the IVP is

$$\begin{aligned} y(t) &= \cos t + [1 - \cos(t - 3\pi)]u_{3\pi}(t) \\ &= \cos t + [1 + \cos t]u_{3\pi}(t). \end{aligned}$$

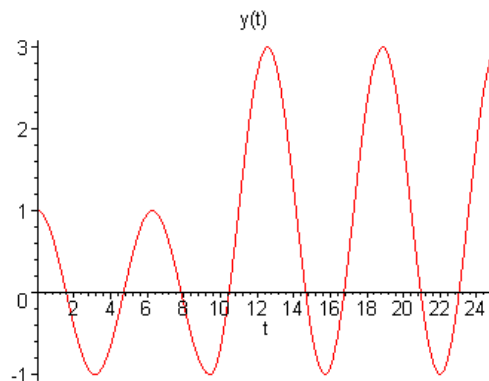
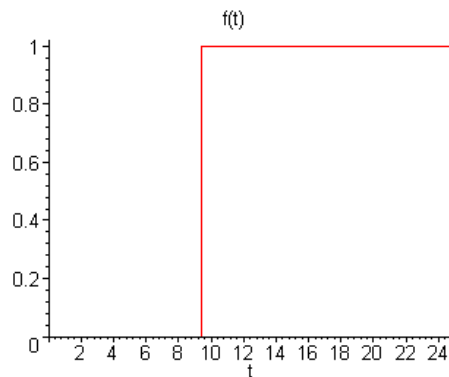

Due to initial conditions, the solution temporarily oscillates about  $y = 0$ . After the forcing is applied, the response is a steady oscillation about  $y_m = 1$ .



9. Let  $g(t)$  be the *forcing function* on the right-hand-side. Taking the Laplace transform of both sides of the ODE, we obtain

$$s^2 Y(s) - s y(0) - y'(0) + Y(s) = \mathcal{L}[g(t)].$$

Applying the initial conditions,

$$s^2 Y(s) + Y(s) - 1 = \mathcal{L}[g(t)].$$

The forcing function can be written as

$$\begin{aligned} g(t) &= \frac{t}{2}[1 - u_6(t)] + 3u_6(t) \\ &= \frac{t}{2} - \frac{1}{2}(t - 6)u_6(t) \end{aligned}$$

with Laplace transform

$$\mathcal{L}[g(t)] = \frac{1}{2s^2} - \frac{e^{-6s}}{2s^2}.$$

Solving for the transform,

$$Y(s) = \frac{1}{s^2 + 1} + \frac{1}{2s^2(s^2 + 1)} - \frac{e^{-6s}}{2s^2(s^2 + 1)}.$$

Using partial fractions,

$$\frac{1}{2s^2(s^2 + 1)} = \frac{1}{2} \left[ \frac{1}{s^2} - \frac{1}{s^2 + 1} \right].$$

Taking the inverse transform, and using Theorem 6.3.1, the solution of the IVP is

$$\begin{aligned} y(t) &= \sin t + \frac{1}{2}[t - \sin t] - \frac{1}{2}[(t - 6) - \sin(t - 6)]u_6(t) \\ &= \frac{1}{2}[t + \sin t] - \frac{1}{2}[(t - 6) - \sin(t - 6)]u_6(t). \end{aligned}$$

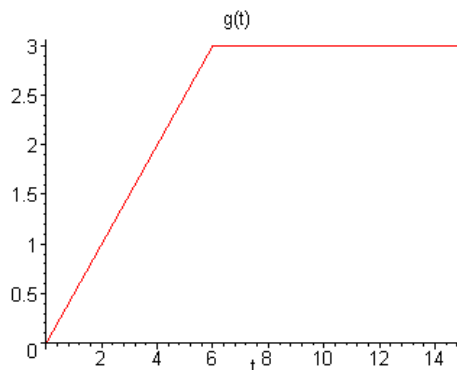

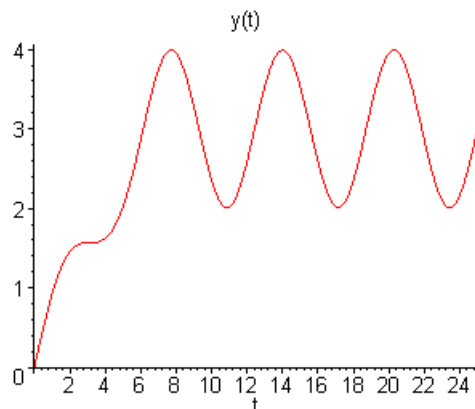

The solution increases, in response to the *ramp input*, and thereafter oscillates about a mean value of  $y_m = 3$ .

11. Taking the Laplace transform of both sides of the ODE, we obtain

$$s^2 Y(s) - s y(0) - y'(0) + 4Y(s) = \frac{e^{-\pi s}}{s} - \frac{e^{-3\pi s}}{s}.$$

Applying the initial conditions,

$$s^2 Y(s) + 4Y(s) = \frac{e^{-\pi s}}{s} - \frac{e^{-3\pi s}}{s}.$$

Solving for the transform,

$$Y(s) = \frac{e^{-\pi s}}{s(s^2 + 4)} - \frac{e^{-3\pi s}}{s(s^2 + 4)}.$$

Using partial fractions,

$$\frac{1}{s(s^2 + 4)} = \frac{1}{4} \left[ \frac{1}{s} - \frac{s}{s^2 + 4} \right].$$

Taking the inverse transform, and applying Theorem 6.3.1,

$$\begin{aligned} y(t) &= \frac{1}{4} [1 - \cos(2t - 2\pi)] u_\pi(t) - \frac{1}{4} [1 - \cos(2t - 6\pi)] u_{3\pi}(t) \\ &= \frac{1}{4} [u_\pi(t) - u_{3\pi}(t)] - \frac{1}{4} \cos 2t \cdot [u_\pi(t) - u_{3\pi}(t)]. \end{aligned}$$

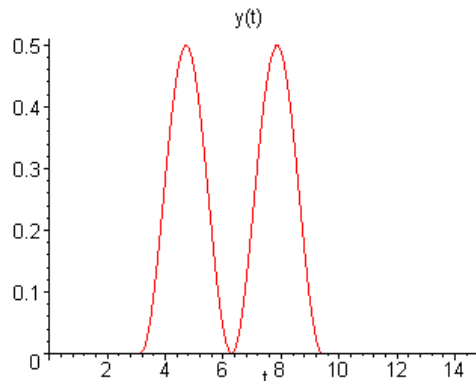
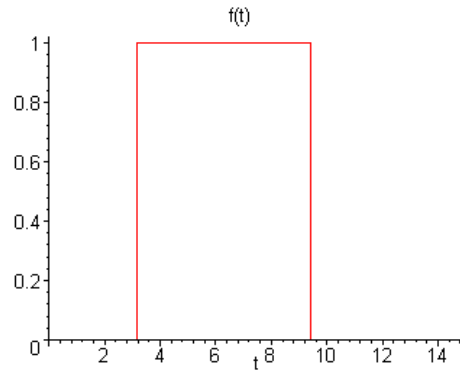

Since there is no damping term, the solution responds immediately to the forcing input. There is a temporary oscillation about  $y = 1/4$ .

12. Taking the Laplace transform of the ODE, we obtain

$$s^4 Y(s) - s^3 y(0) - s^2 y'(0) - s y''(0) - y'''(0) - Y(s) = \frac{e^{-s}}{s} - \frac{e^{-2s}}{s}.$$

Applying the *initial conditions*,

$$s^4 Y(s) - Y(s) = \frac{e^{-s}}{s} - \frac{e^{-2s}}{s}.$$

Solving for the transform of the solution,

$$Y(s) = \frac{e^{-s}}{s(s^4 - 1)} - \frac{e^{-2s}}{s(s^4 - 1)}.$$

Using partial fractions,

$$\frac{1}{s(s^4 - 1)} = \frac{1}{4} \left[ -\frac{4}{s} + \frac{1}{s+1} + \frac{1}{s-1} + \frac{2s}{s^2+1} \right].$$

It follows that

$$\mathcal{L}^{-1}\left[\frac{1}{s(s^4-1)}\right] = \frac{1}{4}[-4 + e^{-t} + e^t + 2\cos t].$$

Based on Theorem 6.3.1, the solution of the IVP is

$$y(t) = -[u_1(t) - u_2(t)] + \frac{1}{4}[e^{-(t-1)} + e^{(t-1)} + 2\cos(t-1)]u_1(t) - \frac{1}{4}[e^{-(t-2)} + e^{(t-2)} + 2\cos(t-2)]u_2(t).$$

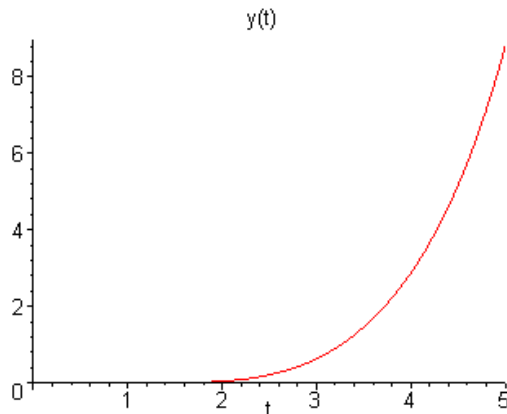
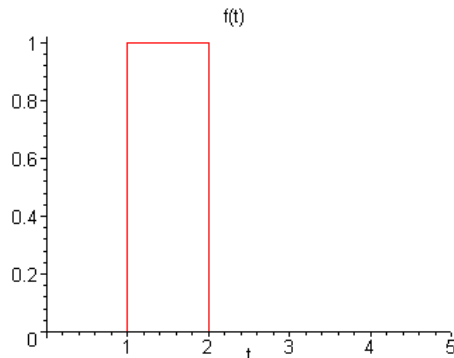

The solution increases without bound, exponentially.

13. Taking the Laplace transform of the ODE, we obtain

$$s^4 Y(s) - s^3 y(0) - s^2 y'(0) - s y''(0) - y'''(0) + 5[s^2 Y(s) - s y(0) - y'(0)] + 4 Y(s) = \frac{1}{s} - \frac{e^{-\pi s}}{s}.$$

Applying the *initial conditions*,

$$s^4 Y(s) + 5s^2 Y(s) + 4Y(s) = \frac{1}{s} - \frac{e^{-\pi s}}{s}.$$

Solving for the transform of the solution,

$$Y(s) = \frac{1}{s(s^4 + 5s^2 + 4)} - \frac{e^{-\pi s}}{s(s^4 + 5s^2 + 4)}.$$

Using partial fractions,

$$\frac{1}{s(s^4 + 5s^2 + 4)} = \frac{1}{12} \left[ \frac{3}{s} + \frac{s}{s^2 + 4} - \frac{4s}{s^2 + 1} \right].$$

It follows that

$$\mathcal{L}^{-1} \left[ \frac{1}{s(s^4 + 5s^2 + 4)} \right] = \frac{1}{12} [3 + \cos 2t - 4 \cos t].$$

Based on Theorem 6.3.1, the solution of the IVP is

$$\begin{aligned} y(t) &= \frac{1}{4} [1 - u_\pi(t)] + \frac{1}{12} [\cos 2t - 4 \cos t] - \\ &\quad - \frac{1}{12} [\cos 2(t - \pi) - 4 \cos(t - \pi)] u_\pi(t). \end{aligned}$$

That is,

$$\begin{aligned} y(t) &= \frac{1}{4} [1 - u_\pi(t)] + \frac{1}{12} [\cos 2t - 4 \cos t] - \\ &\quad - \frac{1}{12} [\cos 2t + 4 \cos t] u_\pi(t). \end{aligned}$$

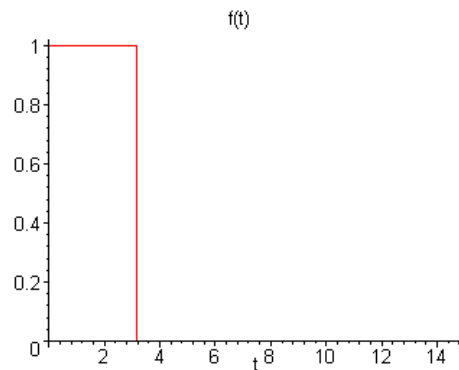

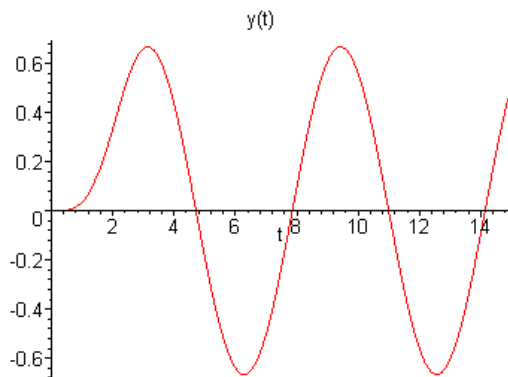

After an initial transient, the solution oscillates about  $y_m = 0$ .

14. The specified function is defined by

$$f(t) = \begin{cases} 0, & 0 \leq t < t_0 \\ \frac{h}{k}(t - t_0), & t_0 \leq t < t_0 + k \\ h, & t \geq t_0 + k \end{cases}$$

which can conveniently be expressed as

$$f(t) = \frac{h}{k}(t - t_0) u_{t_0}(t) - \frac{h}{k}(t - t_0 - k) u_{t_0+k}(t).$$

15. The function is defined by

$$g(t) = \begin{cases} 0, & 0 \leq t < t_0 \\ \frac{h}{k}(t - t_0), & t_0 \leq t < t_0 + k \\ -\frac{h}{k}(t - t_0 - 2k), & t_0 + k \leq t < t_0 + 2k \\ 0, & t \geq t_0 + 2k \end{cases}$$

which can also be written as

$$g(t) = \frac{h}{k}(t - t_0) u_{t_0}(t) - \frac{2h}{k}(t - t_0 - k) u_{t_0+k}(t) + \frac{h}{k}(t - t_0 - 2k) u_{t_0+2k}(t).$$

16(d). From Part (c), the solution is

$$u(t) = 4k u_{3/2}(t) h \left( t - \frac{3}{2} \right) - 4k u_{5/2}(t) h \left( t - \frac{5}{2} \right),$$

where

$$h(t) = \frac{1}{4} - \frac{\sqrt{7}}{84} e^{-t/8} \sin \left( \frac{3\sqrt{7}t}{8} \right) - \frac{1}{4} e^{-t/8} \cos \left( \frac{3\sqrt{7}t}{8} \right).$$

Due to the *damping term*, the solution will decay to *zero*. The maximum will occur

shortly after the forcing ceases. By plotting the various solutions, it appears that the solution will reach a value of  $y = 2$ , as long as  $k > 2.51$ .

(e).

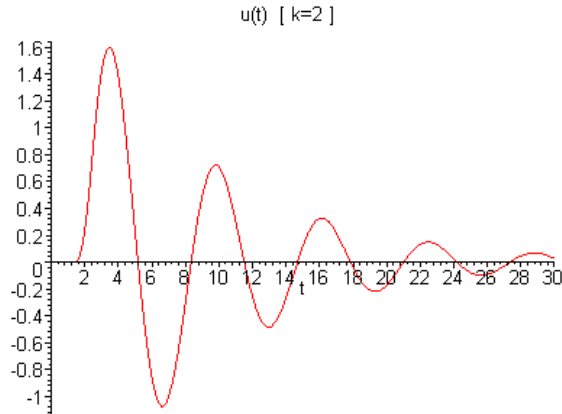

Based on the graph, and numerical calculation,  $|u(t)| < 0.1$  for  $t > 25.6773$ .

17. We consider the initial value problem

$$y'' + 4y = \frac{1}{k}[(t - 5)u_5(t) - (t - 5 - k)u_{5+k}(t)],$$

with  $y(0) = y'(0) = 0$ .

(a). The specified function is defined by

$$f(t) = \begin{cases} 0, & 0 \leq t < 5 \\ \frac{1}{k}(t - 5), & 5 \leq t < 5 + k \\ 1, & t \geq 5 + k \end{cases}$$

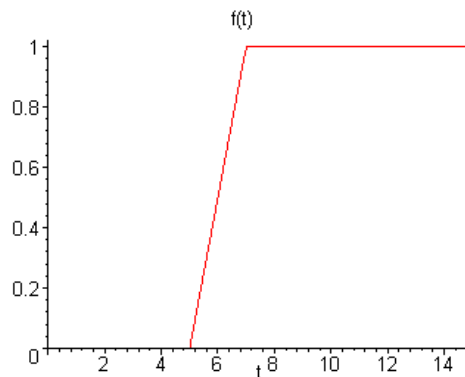

(b). Taking the Laplace transform of both sides of the ODE, we obtain

$$s^2 Y(s) - s y(0) - y'(0) + 4Y(s) = \frac{e^{-5s}}{ks^2} - \frac{e^{-(5+k)s}}{ks^2}.$$

Applying the initial conditions,

$$s^2 Y(s) + 4Y(s) = \frac{e^{-5s}}{ks^2} - \frac{e^{-(5+k)s}}{ks^2}.$$

Solving for the transform,

$$Y(s) = \frac{e^{-5s}}{ks^2(s^2 + 4)} - \frac{e^{-(5+k)s}}{ks^2(s^2 + 4)}.$$

Using partial fractions,

$$\frac{1}{s^2(s^2 + 4)} = \frac{1}{4} \left[ \frac{1}{s^2} - \frac{1}{s^2 + 4} \right].$$

It follows that

$$\mathcal{L}^{-1} \left[ \frac{1}{s^2(s^2 + 4)} \right] = \frac{1}{4}t - \frac{1}{8}\sin 2t.$$

Using Theorem 6.3.1, the solution of the IVP is

$$y(t) = \frac{1}{k} [h(t - 5) u_5(t) - h(t - 5 - k) u_{5+k}(t)],$$

in which  $h(t) = \frac{1}{4}t - \frac{1}{8}\sin 2t$ .

(c). Note that for  $t > 5 + k$ , the solution is given by

$$\begin{aligned} y(t) &= \frac{1}{4} - \frac{1}{8k} \sin(2t - 10) + \frac{1}{8k} \sin(2t - 10 - 2k) \\ &= \frac{1}{4} - \frac{\sin k}{4k} \cos(2t - 10 - k). \end{aligned}$$

So for  $t > 5 + k$ , the solution oscillates about  $y_m = 1/4$ , with an amplitude of

$$A = \frac{|\sin(k)|}{4k}.$$



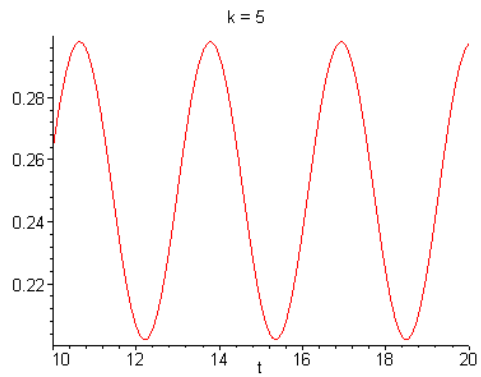
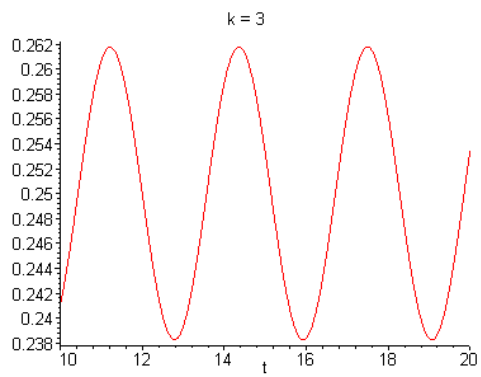
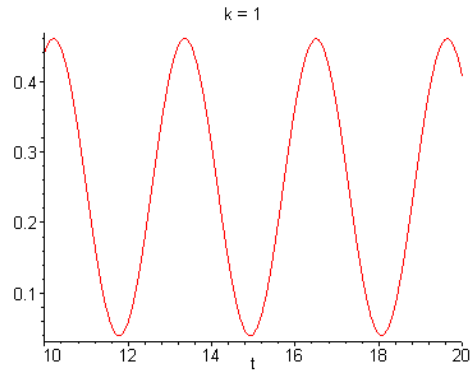

18(a).

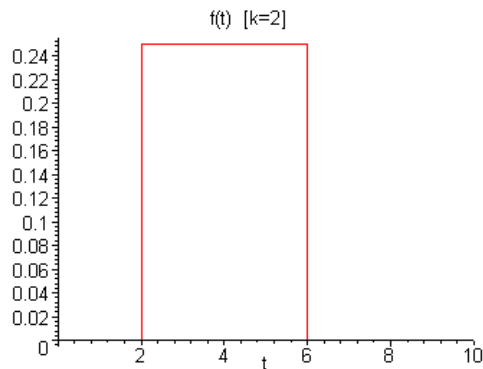

(b). The forcing function can be expressed as

$$f_k(t) = \frac{1}{2k} [u_{4-k}(t) - u_{4+k}(t)].$$

Taking the Laplace transform of both sides of the ODE, we obtain

$$s^2 Y(s) - s y(0) - y'(0) + \frac{1}{3} [s Y(s) - y(0)] + 4 Y(s) = \frac{e^{-(4-k)s}}{2ks} - \frac{e^{-(4+k)s}}{2ks}.$$

Applying the initial conditions,

$$s^2 Y(s) + \frac{1}{3} s Y(s) + 4 Y(s) = \frac{e^{-(4-k)s}}{2ks} - \frac{e^{-(4+k)s}}{2ks}.$$

Solving for the transform,

$$Y(s) = \frac{3 e^{-(4-k)s}}{2ks(3s^2 + s + 12)} - \frac{3 e^{-(4+k)s}}{2ks(3s^2 + s + 12)}.$$

Using partial fractions,

$$\begin{aligned} \frac{1}{s(3s^2 + s + 12)} &= \frac{1}{12} \left[ \frac{1}{s} - \frac{1 + 3s}{3s^2 + s + 12} \right] \\ &= \frac{1}{12} \left[ \frac{1}{s} - \frac{1}{6} \frac{1 + 6(s + \frac{1}{6})}{(s + \frac{1}{6})^2 + \frac{143}{36}} \right]. \end{aligned}$$

Let

$$H(s) = \frac{1}{8k} \left[ \frac{1}{s} - \frac{\frac{1}{6}}{(s + \frac{1}{6})^2 + \frac{143}{36}} - \frac{s + \frac{1}{6}}{(s + \frac{1}{6})^2 + \frac{143}{36}} \right].$$

It follows that

$$h(t) = \mathcal{L}^{-1}[H(s)] = \frac{1}{8k} - \frac{e^{-t/6}}{8k} \left[ \frac{1}{\sqrt{143}} \sin\left(\frac{\sqrt{143}t}{6}\right) + \cos\left(\frac{\sqrt{143}t}{6}\right) \right].$$

Based on Theorem 6.3.1, the solution of the IVP is

$$y(t) = h(t - 4 + k) u_{4-k}(t) - h(t - 4 - k) u_{4+k}(t).$$

(c).

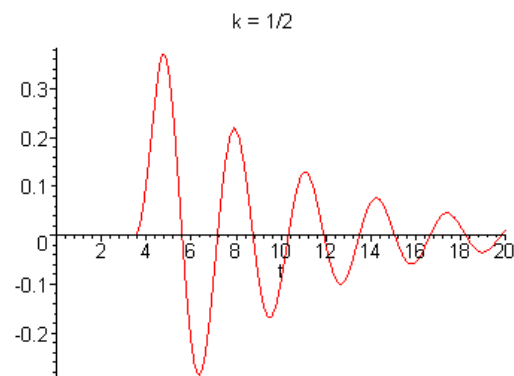
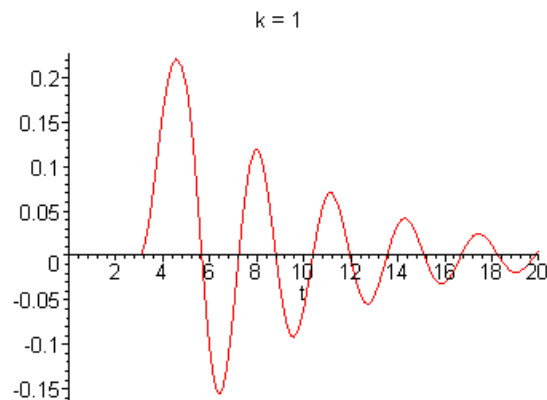
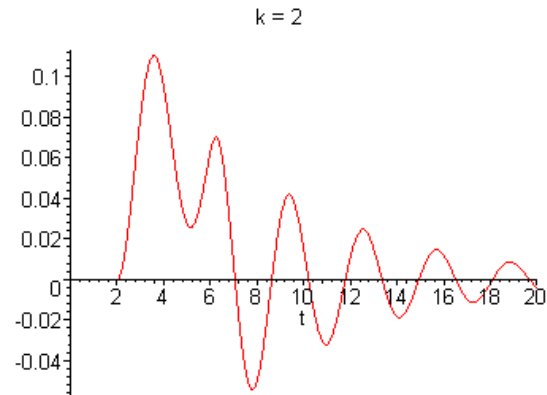

As the parameter  $k$  decreases, the solution remains *null* for a longer period of time.

Since the *magnitude* of the impulsive force *increases*, the initial *overshoot* of the response also increases. The *duration* of the impulse decreases. All solutions eventually decay to  $y = 0$ .

19(a).

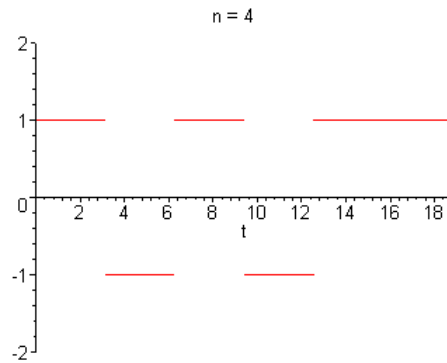

(c). From Part (b),

$$u(t) = 1 - \cos t + 2 \sum_{k=1}^n (-1)^k [1 - \cos(t - k\pi)] u_{k\pi}(t).$$

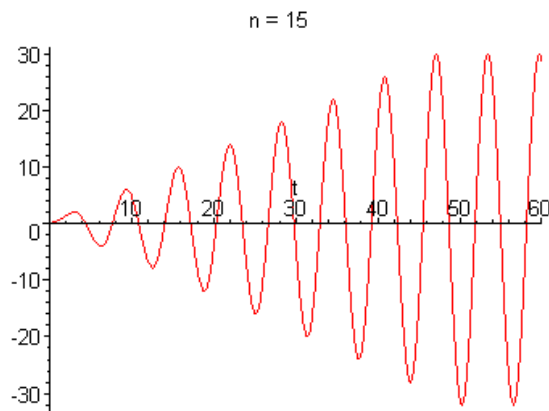

21(a).

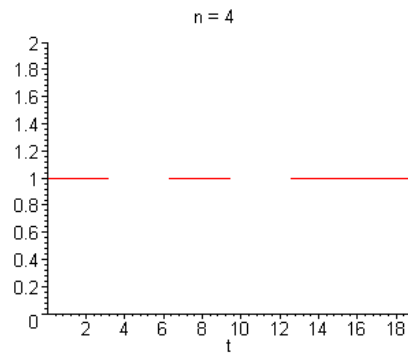
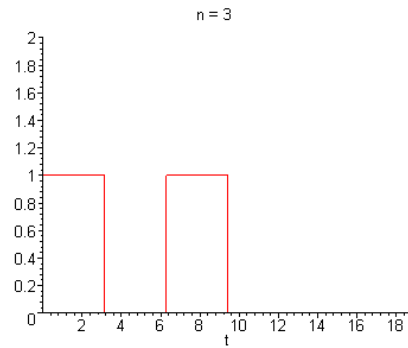

(b). Taking the Laplace transform of both sides of the ODE, we obtain

$$s^2 U(s) - s u(0) - u'(0) + U(s) = \frac{1}{s} + \sum_{k=1}^n \frac{(-1)^k e^{-k\pi s}}{s}.$$

Applying the initial conditions,

$$s^2 U(s) + U(s) = \frac{1}{s} + \sum_{k=1}^n \frac{(-1)^k e^{-k\pi s}}{s}.$$

Solving for the transform,

$$U(s) = \frac{1}{s(s^2 + 1)} + \sum_{k=1}^n \frac{(-1)^k e^{-k\pi s}}{s(s^2 + 1)}.$$

Using partial fractions,

$$\frac{1}{s(s^2 + 1)} = \frac{1}{s} - \frac{s}{s^2 + 1}.$$

Let

$$h(t) = \mathcal{L}^{-1}\left[\frac{1}{s(s^2 + 1)}\right] = 1 - \cos t.$$

Applying Theorem 6.3.1, term-by-term, the solution of the IVP is

$$u(t) = h(t) + \sum_{k=1}^n (-1)^k h(t - k\pi) u_{k\pi}(t).$$

Note that

$$\begin{aligned} h(t - k\pi) &= u_0(t - k\pi) - \cos(t - k\pi) \\ &= u_{k\pi}(t) - (-1)^k \cos t. \end{aligned}$$

Hence

$$u(t) = 1 - \cos t + \sum_{k=1}^n (-1)^k u_{k\pi}(t) - (\cos t) \sum_{k=1}^n u_{k\pi}(t).$$

(c).

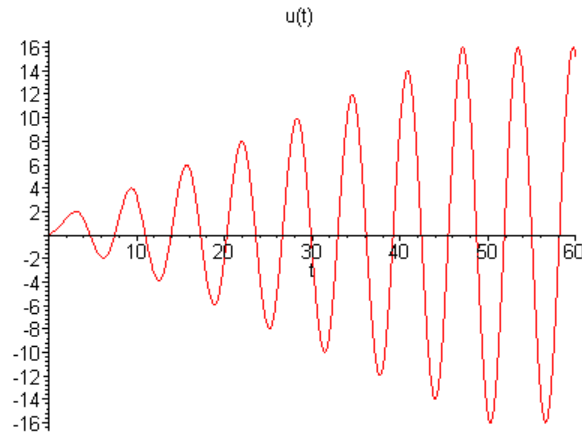

The ODE has no *damping term*. Each interval of forcing adds to the energy of the system.

Hence the amplitude will increase. For  $n = 15$ ,  $g(t) = 0$  when  $t > 15\pi$ . Therefore the oscillation will eventually become *steady*, with an amplitude depending on the values of  $u(15\pi)$  and  $u'(15\pi)$ .

(d). As  $n$  increases, the interval of forcing also increases. Hence the amplitude of the transient will increase with  $n$ . Eventually, the forcing function will be *constant*. In fact, for *large* values of  $t$ ,

$$g(t) = \begin{cases} 1, & n \text{ even} \\ 0, & n \text{ odd} \end{cases}$$

Further, for  $t > n\pi$ ,

$$u(t) = 1 - \cos t - n \cos t - \frac{1 - (-1)^n}{2}.$$

Hence the steady state solution will oscillate about 0 or 1, depending on  $n$ , with an amplitude of  $A = n + 1$ .

In the limit, as  $n \rightarrow \infty$ , the forcing function will be a periodic function, with period  $2\pi$ . From Prob. 27, in Section 6.3,

$$\mathcal{L}[g(t)] = \frac{1}{s(1 + e^{-s})}.$$

As  $n$  increases, the duration and magnitude of the transient will increase without bound.

22(a). Taking the initial conditions into consideration, the transform of the ODE is

$$s^2 U(s) + 0.1 s U(s) + U(s) = \frac{1}{s} + \sum_{k=1}^n \frac{(-1)^k e^{-k\pi s}}{s}.$$

Solving for the transform,

$$U(s) = \frac{1}{s(s^2 + 0.1s + 1)} + \sum_{k=1}^n \frac{(-1)^k e^{-k\pi s}}{s(s^2 + 0.1s + 1)}.$$

Using partial fractions,

$$\frac{1}{s(s^2 + 0.1s + 1)} = \frac{1}{s} - \frac{s + 0.1}{s^2 + 0.1s + 1}.$$

Since the denominator in the second term is irreducible, write

$$\frac{s + 0.1}{s^2 + 0.1s + 1} = \frac{(s + 0.05) + 0.05}{(s + 0.05)^2 + (399/400)}.$$

Let

$$\begin{aligned} h(t) &= \mathcal{L}^{-1} \left[ \frac{1}{s} - \frac{(s + 0.05)}{(s + 0.05)^2 + (399/400)} - \frac{0.05}{(s + 0.05)^2 + (399/400)} \right] \\ &= 1 - e^{-t/20} \left[ \cos \left( \frac{\sqrt{399}}{20} t \right) + \frac{1}{\sqrt{399}} \sin \left( \frac{\sqrt{399}}{20} t \right) \right]. \end{aligned}$$

Applying Theorem 6.3.1, term-by-term, the solution of the IVP is

$$u(t) = h(t) + \sum_{k=1}^n (-1)^k h(t - k\pi) u_{k\pi}(t).$$

For *odd* values of  $n$ , the solution approaches  $y = 0$ .

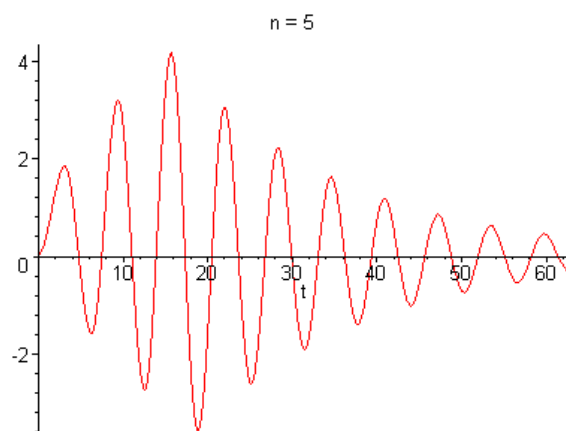

For *even* values of  $n$ , the solution approaches  $y = 1$ .

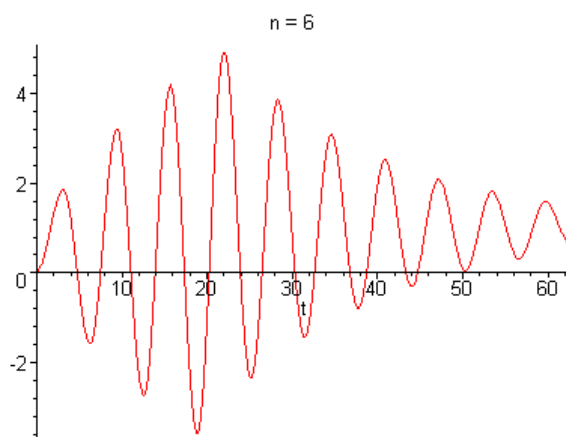

(b). The solution is a sum of *damped sinusoids*, each of frequency  $\omega = \sqrt{399}/20 \approx 1$ . Each term has an 'initial' amplitude of approximately 1. For any given  $n$ , the solution contains  $n + 1$  such terms. Although the amplitude will *increase* with  $n$ , the amplitude will also be bounded by  $n + 1$ .

(c). Suppose that the forcing function is replaced by  $g(t) = \sin t$ . Based on the methods in Chapter 3, the general solution of the differential equation is

$$u(t) = e^{-t/20} \left[ c_1 \cos\left(\frac{\sqrt{399}}{20} t\right) + c_2 \sin\left(\frac{\sqrt{399}}{20} t\right) \right] + u_p(t).$$

Note that  $u_p(t) = A \cos t + B \sin t$ . Using the method of *undetermined coefficients*,  $A = -10$  and  $B = 0$ . Based on the initial conditions, the solution of the IVP is



$$u(t) = 10 e^{-t/20} \left[ \cos \left( \frac{\sqrt{399}}{20} t \right) + \frac{1}{\sqrt{399}} \sin \left( \frac{\sqrt{399}}{20} t \right) \right] - 10 \cos t.$$

Observe that both solutions have the same frequency,  $\omega = \sqrt{399}/20 \approx 1$ .

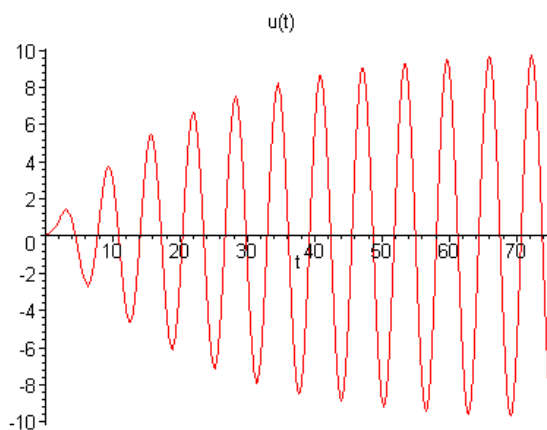

23(a). Taking the initial conditions into consideration, the transform of the ODE is

$$s^2 U(s) + U(s) = \frac{1}{s} + 2 \sum_{k=1}^n \frac{(-1)^k e^{-(11k/4)s}}{s}.$$

Solving for the transform,

$$U(s) = \frac{1}{s(s^2 + 1)} + 2 \sum_{k=1}^n \frac{(-1)^k e^{-(11k/4)s}}{s(s^2 + 1)}.$$

Using partial fractions,

$$\frac{1}{s(s^2 + 1)} = \frac{1}{s} - \frac{s}{s^2 + 1}.$$

Let

$$h(t) = \mathcal{L}^{-1} \left[ \frac{1}{s(s^2 + 1)} \right] = 1 - \cos t.$$

Applying Theorem 6.3.1, term-by-term, the solution of the IVP is

$$u(t) = h(t) + 2 \sum_{k=1}^n (-1)^k h \left( t - \frac{11k}{4} \right) u_{11k/4}(t).$$

That is,

$$u(t) = 1 - \cos t + 2 \sum_{k=1}^n (-1)^k \left[ 1 - \cos \left( t - \frac{11k}{4} \right) \right] u_{11k/4}(t).$$

(b).

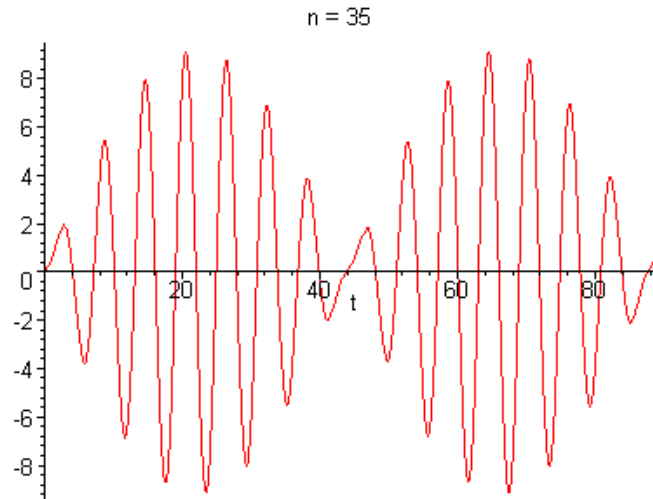

(c). Based on the plot, the '*slow period*' appears to be 88. The '*fast period*' appears to be about 6. These values correspond to a '*slow frequency*' of  $\omega_s = 0.0714$  and a '*fast frequency*'  $\omega_f = 1.0472$ .

(d). The natural frequency of the system is  $\omega_0 = 1$ . The forcing function is initially periodic, with period  $T = 11/2 = 5.5$ . Hence the corresponding forcing frequency is  $\omega = 1.1424$ . Using the results in Section 3.9, the '*slow frequency*' is given by

$$\omega_s = \frac{|\omega - \omega_0|}{2} = 0.0712$$

and the '*fast frequency*' is given by

$$\omega_f = \frac{|\omega + \omega_0|}{2} = 1.0712.$$

Based on these values, the '*slow period*' is predicted as 88.247 and the '*fast period*' is given as 5.8656.

## Section 6.5

2. Taking the Laplace transform of both sides of the ODE, we obtain

$$s^2 Y(s) - s y(0) - y'(0) + 4Y(s) = e^{-\pi s} - e^{-2\pi s}.$$

Applying the initial conditions,

$$s^2 Y(s) + 4Y(s) = e^{-\pi s} - e^{-2\pi s}.$$

Solving for the transform,

$$Y(s) = \frac{e^{-\pi s} - e^{-2\pi s}}{s^2 + 4} = \frac{e^{-\pi s}}{s^2 + 4} - \frac{e^{-2\pi s}}{s^2 + 4}.$$

Applying Theorem 6.3.1, the solution of the IVP is

$$\begin{aligned} y(t) &= \frac{1}{2} \sin(2t - 2\pi) u_{\pi}(t) - \frac{1}{2} \sin(2t - 4\pi) u_{2\pi}(t) \\ &= \frac{1}{2} \sin(2t) [u_{\pi}(t) - u_{2\pi}(t)]. \end{aligned}$$

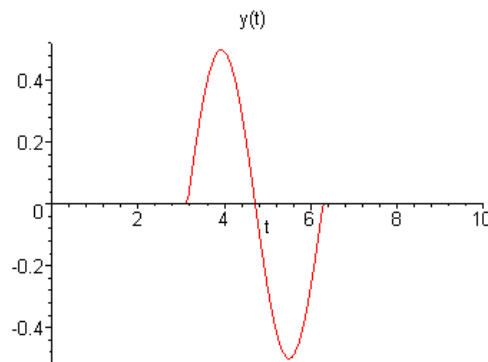

4. Taking the Laplace transform of both sides of the ODE, we obtain

$$s^2 Y(s) - s y(0) - y'(0) - Y(s) = -20 e^{-3s}.$$

Applying the initial conditions,

$$s^2 Y(s) - Y(s) - s = -20 e^{-3s}.$$

Solving for the transform,

$$Y(s) = \frac{s}{s^2 - 1} - \frac{20 e^{-3s}}{s^2 - 1}.$$

Using a *table of transforms*, and Theorem 6.3.1, the solution of the IVP is

$$y(t) = \cosh t - 20 \sinh(t - 3) u_3(t).$$

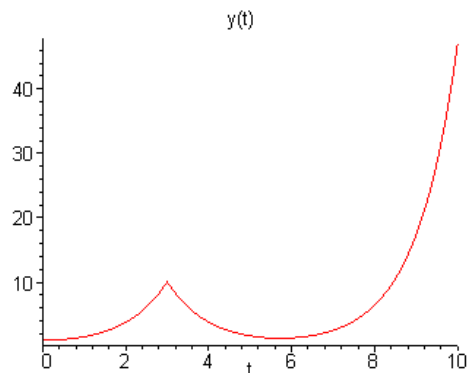

6. Taking the initial conditions into consideration, the transform of the ODE is

$$s^2 Y(s) + 4Y(s) - s/2 = e^{-4\pi s}.$$

Solving for the transform,

$$Y(s) = \frac{s/2}{s^2 + 4} + \frac{e^{-4\pi s}}{s^2 + 4}.$$

Using a *table of transforms*, and Theorem 6.3.1, the solution of the IVP is

$$\begin{aligned} y(t) &= \frac{1}{2} \cos 2t + \frac{1}{2} \sin(2t - 8\pi) u_{4\pi}(t) \\ &= \frac{1}{2} \cos 2t + \frac{1}{2} \sin(2t) u_{4\pi}(t). \end{aligned}$$

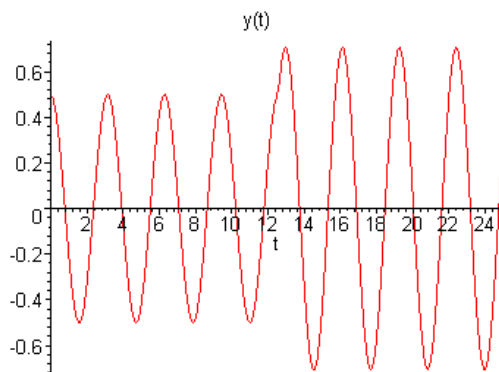

8. Taking the Laplace transform of both sides of the ODE, we obtain

$$s^2 Y(s) - s y(0) - y'(0) + 4Y(s) = 2 e^{-(\pi/4)s}.$$

Applying the initial conditions,

$$s^2 Y(s) + 4Y(s) = 2 e^{-(\pi/4)s}.$$

Solving for the transform,

$$Y(s) = \frac{2e^{-(\pi/4)s}}{s^2 + 4}.$$

Applying Theorem 6.3.1, the solution of the IVP is

$$y(t) = \sin\left(2t - \frac{\pi}{2}\right)u_{\pi/4}(t) = -\cos(2t)u_{\pi/4}(t).$$

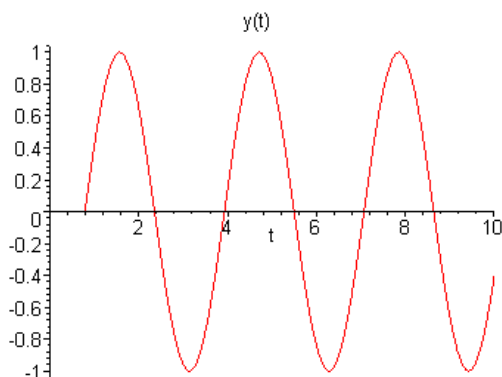

9. Taking the initial conditions into consideration, the transform of the ODE is

$$s^2 Y(s) + Y(s) = \frac{e^{-(\pi/2)s}}{s} + 3e^{-(3\pi/2)s} - \frac{e^{-2\pi s}}{s}.$$

Solving for the transform,

$$Y(s) = \frac{e^{-(\pi/2)s}}{s(s^2 + 1)} + \frac{3e^{-(3\pi/2)s}}{s^2 + 1} - \frac{e^{-2\pi s}}{s(s^2 + 1)}.$$

Using partial fractions,

$$\frac{1}{s(s^2 + 1)} = \frac{1}{s} - \frac{s}{s^2 + 1}.$$

Hence

$$Y(s) = \frac{e^{-(\pi/2)s}}{s} - \frac{s e^{-(\pi/2)s}}{s^2 + 1} + \frac{3e^{-(3\pi/2)s}}{s^2 + 1} - \frac{e^{-2\pi s}}{s} + \frac{s e^{-2\pi s}}{s^2 + 1}.$$

Based on Theorem 6.3.1, the solution of the IVP is

$$y(t) = u_{\pi/2}(t) - \cos\left(t - \frac{\pi}{2}\right)u_{\pi/2}(t) + 3\sin\left(t - \frac{3\pi}{2}\right)u_{3\pi/2}(t) - u_{2\pi}(t) + \cos(t - 2\pi)u_{2\pi}(t).$$

That is,

$$y(t) = [1 - \sin(t)]u_{\pi/2}(t) + 3\cos(t)u_{3\pi/2}(t) - [1 - \cos(t)]u_{2\pi}(t).$$

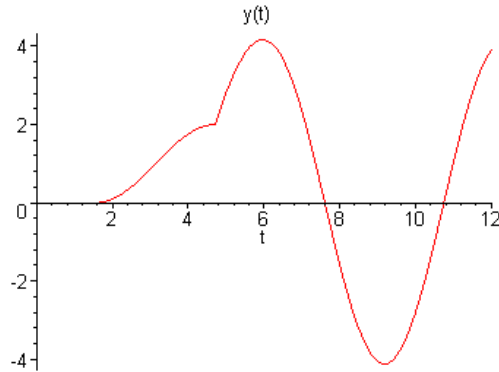

10. Taking the transform of both sides of the ODE,

$$\begin{aligned} 2s^2Y(s) + sY(s) + 4Y(s) &= \int_0^\infty e^{-st} \delta\left(t - \frac{\pi}{6}\right) \sin t \, dt \\ &= \frac{1}{2} e^{-(\pi/6)s}. \end{aligned}$$

Solving for the transform,

$$Y(s) = \frac{e^{-(\pi/6)s}}{2(2s^2 + s + 4)}.$$

First write

$$\frac{1}{2(2s^2 + s + 4)} = \frac{\frac{1}{4}}{\left(s + \frac{1}{4}\right)^2 + \frac{31}{16}}.$$

It follows that

$$y(t) = \mathcal{L}^{-1}[Y(s)] = \frac{1}{\sqrt{31}} e^{-(t-\pi/6)/4} \cdot \sin \frac{\sqrt{31}}{4} \left(t - \frac{\pi}{6}\right) u_{\pi/6}(t).$$

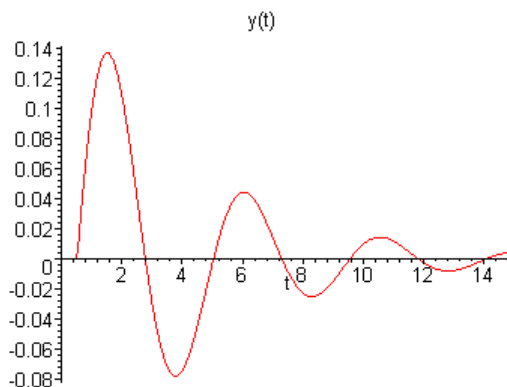

11. Taking the initial conditions into consideration, the transform of the ODE is

$$s^2 Y(s) + 2s Y(s) + 2 Y(s) = \frac{s}{s^2 + 1} + e^{-(\pi/2)s}.$$

Solving for the transform,

$$Y(s) = \frac{s}{(s^2 + 1)(s^2 + 2s + 2)} + \frac{e^{-(\pi/2)s}}{s^2 + 2s + 2}.$$

Using partial fractions,

$$\frac{s}{(s^2 + 1)(s^2 + 2s + 2)} = \frac{1}{5} \left[ \frac{s}{s^2 + 1} + \frac{2}{s^2 + 1} - \frac{s + 4}{s^2 + 2s + 2} \right].$$

We can also write

$$\frac{s + 4}{s^2 + 2s + 2} = \frac{(s + 1) + 3}{(s + 1)^2 + 1}.$$

Let

$$Y_1(s) = \frac{s}{(s^2 + 1)(s^2 + 2s + 2)}.$$

Then

$$\mathcal{L}^{-1}[Y_1(s)] = \frac{1}{5} \cos t + \frac{2}{5} \sin t - \frac{1}{5} e^{-t} [\cos t + 3 \sin t].$$

Applying Theorem 6.3.1,

$$\mathcal{L}^{-1} \left[ \frac{e^{-(\pi/2)s}}{s^2 + 2s + 2} \right] = e^{-(t-\frac{\pi}{2})} \sin \left( t - \frac{\pi}{2} \right) u_{\pi/2}(t).$$

Hence the solution of the IVP is

$$y(t) = \frac{1}{5} \cos t + \frac{2}{5} \sin t - \frac{1}{5} e^{-t} [\cos t + 3 \sin t] - e^{-(t-\frac{\pi}{2})} \cos(t) u_{\pi/2}(t).$$

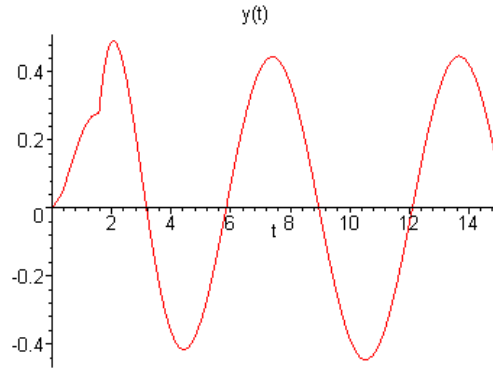

12. Taking the initial conditions into consideration, the transform of the ODE is

$$s^4 Y(s) - Y(s) = e^{-s}.$$

Solving for the transform,

$$Y(s) = \frac{e^{-s}}{s^4 - 1}.$$

Using partial fractions,

$$\frac{1}{s^4 - 1} = \frac{1}{2} \left[ \frac{1}{s^2 - 1} - \frac{1}{s^2 + 1} \right].$$

It follows that

$$\mathcal{L}^{-1} \left[ \frac{1}{s^4 - 1} \right] = \frac{1}{2} \sinh t - \frac{1}{2} \sin t.$$

Applying Theorem 6.3.1, the solution of the IVP is

$$y(t) = \frac{1}{2} [\sinh(t - 1) - \sin(t - 1)] u_1(t).$$

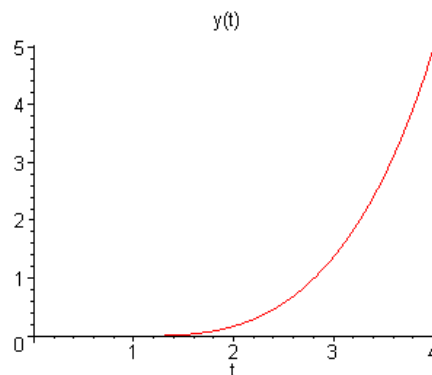



14(a). The Laplace transform of the ODE is

$$s^2 Y(s) + \frac{1}{2}s Y(s) + Y(s) = e^{-s}.$$

Solving for the transform of the solution,

$$Y(s) = \frac{e^{-s}}{s^2 + s/2 + 1}.$$

First write

$$\frac{1}{s^2 + s/2 + 1} = \frac{1}{\left(s + \frac{1}{4}\right)^2 + \frac{15}{16}}.$$

Taking the inverse transform and applying both *shifting theorems*,

$$y(t) = \frac{4}{\sqrt{15}} e^{-(t-1)/4} \sin \frac{\sqrt{15}}{4} (t-1) u_1(t).$$

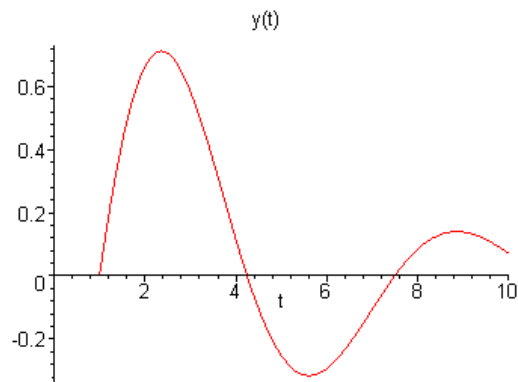

(b). As shown on the graph, the maximum is attained at some  $t_1 > 2$ . Note that for  $t > 2$ ,

$$y(t) = \frac{4}{\sqrt{15}} e^{-(t-1)/4} \sin \frac{\sqrt{15}}{4} (t-1).$$

Setting  $y'(t) = 0$ , we find that  $t_1 \approx 2.3613$ . The maximum value is calculated as  $y(2.3613) \approx 0.71153$ .

(c). Setting  $\gamma = 1/4$ , the transform of the solution is

$$Y(s) = \frac{e^{-s}}{s^2 + s/4 + 1}.$$

Following the same steps, it follows that

$$y(t) = \frac{8}{3\sqrt{7}} e^{-(t-1)/8} \sin \frac{3\sqrt{7}}{8} (t-1) u_1(t).$$

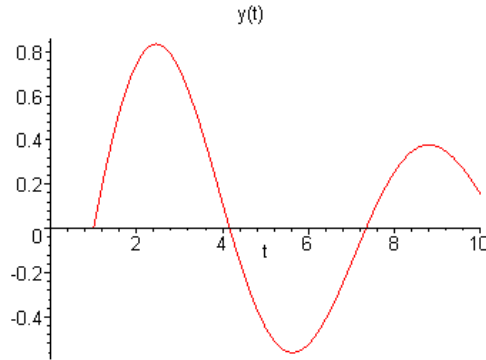

Once again, the maximum is attained at some  $t_1 > 2$ . Setting  $y'(t) = 0$ , we find that  $t_1 \approx 2.4569$ , with  $y(t_1) \approx 0.8335$ .

(d). Now suppose that  $0 < \gamma < 1$ . Then the transform of the solution is

$$Y(s) = \frac{e^{-s}}{s^2 + \gamma s + 1}.$$

First write

$$\frac{1}{s^2 + \gamma s + 1} = \frac{1}{(s + \gamma/2)^2 + (1 - \gamma^2/4)}.$$

It follows that

$$h(t) = \mathcal{L}^{-1} \left[ \frac{1}{s^2 + \gamma s + 1} \right] = \frac{2}{\sqrt{4 - \gamma^2}} e^{-\gamma t/2} \sin \left( \sqrt{1 - \gamma^2/4} \cdot t \right).$$

Hence the solution is

$$y(t) = h(t-1) u_1(t).$$

The solution is nonzero only if  $t > 1$ , in which case  $y(t) = h(t-1)$ . Setting  $y'(t) = 0$ , we obtain

$$\tan \left[ \sqrt{1 - \gamma^2/4} \cdot (t-1) \right] = \frac{1}{\gamma} \sqrt{4 - \gamma^2},$$

that is,

$$\frac{\tan \left[ \sqrt{1 - \gamma^2/4} \cdot (t-1) \right]}{\sqrt{1 - \gamma^2/4}} = \frac{2}{\gamma}.$$

As  $\gamma \rightarrow 0$ , we obtain the *formal* equation  $\tan(t - 1) = \infty$ . Hence  $t_1 \rightarrow 1 + \frac{\pi}{2}$ . Setting  $t = \pi/2$  in  $h(t)$ , and letting  $\gamma \rightarrow 0$ , we find that  $y_1 \rightarrow 1$ . These conclusions agree with the case  $\gamma = 0$ , for which it is easy to show that the solution is

$$y(t) = \sin(t - 1) u_1(t).$$

15(a). See Prob. 14. It follows that the solution of the IVP is

$$y(t) = \frac{4k}{\sqrt{15}} e^{-(t-1)/4} \sin \frac{\sqrt{15}}{4} (t - 1) u_1(t).$$

This function is a *multiple* of the answer in Prob. 14(a). Hence the peak value occurs at  $t_1 \approx 2.3613$ . The maximum value is calculated as  $y(2.3613) \approx 0.71153 k$ . We find that the appropriate value of  $k$  is  $k_1 = 2/0.71153 \approx 2.8108$ .

(b). Based on Prob. 14(c), the solution is

$$y(t) = \frac{8k}{3\sqrt{7}} e^{-(t-1)/8} \sin \frac{3\sqrt{7}}{8} (t - 1) u_1(t).$$

Since this function is a *multiple* of the solution in Prob. 14(c), we have  $t_1 \approx 2.4569$ , with  $y(t_1) \approx 0.8335 k$ . The solution attains a value of  $y = 2$ , for  $k_1 = 2/0.8335$ , that is,  $k_1 \approx 2.3995$ .

(c). Similar to Prob. 14(d), for  $0 < \gamma < 1$ , the solution is

$$y(t) = h(t - 1) u_1(t),$$

in which

$$h(t) = \frac{2k}{\sqrt{4 - \gamma^2}} e^{-\gamma t/2} \sin\left(\sqrt{1 - \gamma^2/4} \cdot t\right).$$

It follows that  $t_1 - 1 \rightarrow \pi/2$ . Setting  $t = \pi/2$  in  $h(t)$ , and letting  $\gamma \rightarrow 0$ , we find that  $y_1 \rightarrow k$ . Requiring that the *peak value* remains at  $y = 2$ , the limiting value of  $k$  is  $k_1 = 2$ . These conclusions agree with the case  $\gamma = 0$ , for which it is easy to show that the solution is

$$y(t) = k \sin(t - 1) u_1(t).$$

16(a). Taking the initial conditions into consideration, the transformation of the ODE is

$$s^2 Y(s) + Y(s) = \frac{1}{2k} \left[ \frac{e^{-(4-k)s}}{s} - \frac{e^{-(4+k)s}}{s} \right].$$

Solving for the transform of the solution,

$$Y(s) = \frac{1}{2k} \left[ \frac{e^{-(4-k)s}}{s(s^2 + 1)} - \frac{e^{-(4+k)s}}{s(s^2 + 1)} \right].$$

Using partial fractions,

$$\frac{1}{s(s^2 + 1)} = \frac{1}{s} - \frac{s}{s^2 + 1}.$$

Now let

$$h(t) = \mathcal{L}^{-1} \left[ \frac{1}{s(s^2 + 1)} \right] = 1 - \cos t.$$

Applying Theorem 6.3.1, the solution is

$$\phi(t, k) = \frac{1}{2k} [h(t - 4 + k) u_{4-k}(t) - h(t - 4 - k) u_{4+k}(t)].$$

That is,

$$\begin{aligned} \phi(t, k) &= \frac{1}{2k} [u_{4-k}(t) - u_{4+k}(t)] - \\ &\quad - \frac{1}{2k} [\cos(t - 4 + k) u_{4-k}(t) - \cos(t - 4 - k) u_{4+k}(t)]. \end{aligned}$$

(b). Consider various values of  $t$ . For any fixed  $t < 4$ ,  $\phi(t, k) = 0$ , as long as  $4 - k > t$ . If  $t \geq 4$ , then for  $4 + k < t$ ,

$$\phi(t, k) = -\frac{1}{2k} [\cos(t - 4 + k) - \cos(t - 4 - k)].$$

It follows that

$$\begin{aligned} \lim_{k \rightarrow 0} \phi(t, k) &= \lim_{k \rightarrow 0} -\frac{\cos(t - 4 + k) - \cos(t - 4 - k)}{2k} \\ &= \sin(t - 4). \end{aligned}$$

Hence

$$\lim_{k \rightarrow 0} \phi(t, k) = \sin(t - 4) u_4(t).$$

(c). The Laplace transform of the differential equation

$$y'' + y = \delta(t - 4),$$

with  $y(0) = y'(0) = 0$ , is

$$s^2 Y(s) + Y(s) = e^{-4s}.$$

Solving for the transform of the solution,

$$Y(s) = \frac{e^{-4s}}{s^2 + 1}.$$

It follows that the solution is

$$\phi_0(t) = \sin(t - 4) u_4(t).$$

(d).

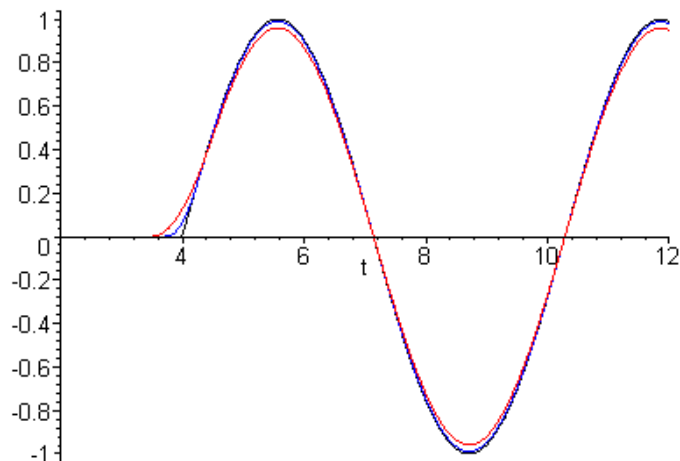

18(b). The transform of the ODE (given the specified initial conditions) is

$$s^2 Y(s) + Y(s) = \sum_{k=1}^{20} (-1)^{k+1} e^{-k\pi s}.$$

Solving for the transform of the solution,

$$Y(s) = \frac{1}{s^2 + 1} \sum_{k=1}^{20} (-1)^{k+1} e^{-k\pi s}.$$

Applying Theorem 6.3.1, term-by-term,

$$\begin{aligned} y(t) &= \sum_{k=1}^{20} (-1)^{k+1} \sin(t - k\pi) u_{k\pi}(t) \\ &= -\sin(t) \cdot \sum_{k=1}^{20} u_{k\pi}(t). \end{aligned}$$

(c).

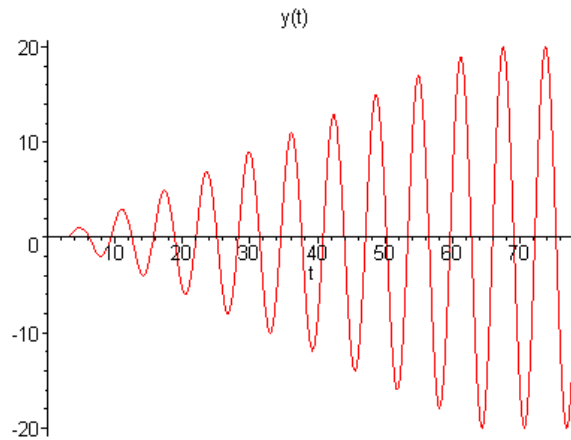

19(b). Taking the initial conditions into consideration, the transform of the ODE is

$$s^2 Y(s) + Y(s) = \sum_{k=1}^{20} e^{-(k\pi/2)s}.$$

Solving for the transform of the solution,

$$Y(s) = \frac{1}{s^2 + 1} \sum_{k=1}^{20} e^{-(k\pi/2)s}.$$

Applying Theorem 6.3.1, term-by-term,

$$y(t) = \sum_{k=1}^{20} \sin\left(t - \frac{k\pi}{2}\right) u_{k\pi/2}(t).$$

(c).

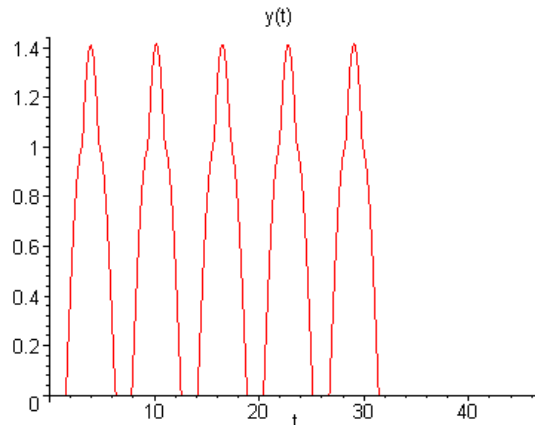

20(b). The transform of the ODE (given the specified initial conditions) is

$$s^2 Y(s) + Y(s) = \sum_{k=1}^{20} (-1)^{k+1} e^{-(k\pi/2)s}.$$

Solving for the transform of the solution,

$$Y(s) = \sum_{k=1}^{20} (-1)^{k+1} \frac{e^{-(k\pi/2)s}}{s^2 + 1}.$$

Applying Theorem 6.3.1, term-by-term,

$$y(t) = \sum_{k=1}^{20} (-1)^{k+1} \sin\left(t - \frac{k\pi}{2}\right) u_{k\pi/2}(t).$$

(c).

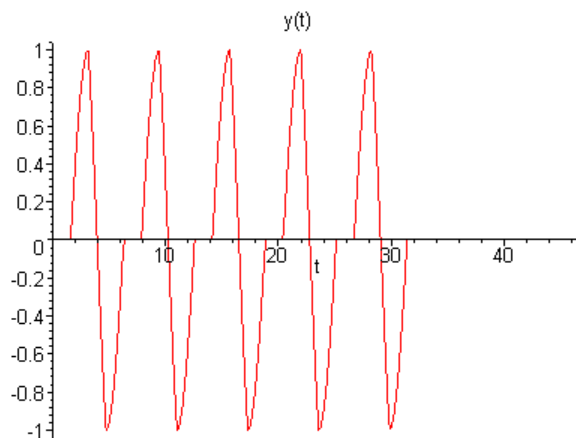

22(b). Taking the initial conditions into consideration, the transform of the ODE is

$$s^2 Y(s) + Y(s) = \sum_{k=1}^{40} (-1)^{k+1} e^{-(11k/4)s}.$$

Solving for the transform of the solution,

$$Y(s) = \sum_{k=1}^{40} (-1)^{k+1} \frac{e^{-(11k/4)s}}{s^2 + 1}.$$

Applying Theorem 6.3.1, term-by-term,

$$y(t) = \sum_{k=1}^{40} (-1)^{k+1} \sin\left(t - \frac{11k}{4}\right) u_{11k/4}(t).$$

(c).

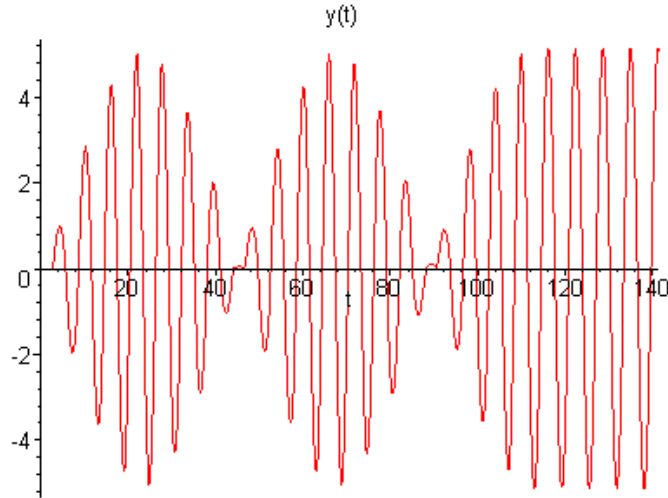

23(b). The transform of the ODE (given the specified initial conditions) is

$$s^2 Y(s) + 0.1s Y(s) + Y(s) = \sum_{k=1}^{20} (-1)^{k+1} e^{-k\pi s}.$$

Solving for the transform of the solution,

$$Y(s) = \sum_{k=1}^{20} \frac{e^{-k\pi s}}{s^2 + 0.1s + 1}.$$

First write

$$\frac{1}{s^2 + 0.1s + 1} = \frac{1}{\left(s + \frac{1}{20}\right)^2 + \frac{399}{400}}.$$

It follows that

$$\mathcal{L}^{-1}\left[\frac{1}{s^2 + 0.1s + 1}\right] = \frac{20}{\sqrt{399}} e^{-t/20} \sin\left(\frac{\sqrt{399}}{20} t\right).$$

Applying Theorem 6.3.1, term-by-term,



$$y(t) = \sum_{k=1}^{20} (-1)^{k+1} h(t - k\pi) u_{k\pi}(t),$$

in which

$$h(t) = \frac{20}{\sqrt{399}} e^{-t/20} \sin\left(\frac{\sqrt{399}}{20} t\right).$$

(c).

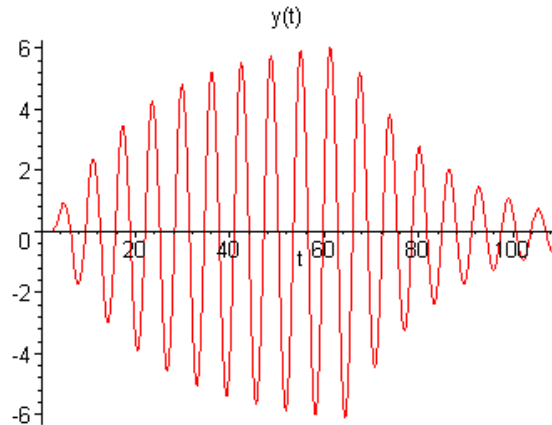

24(b). Taking the initial conditions into consideration, the transform of the ODE is

$$s^2 Y(s) + 0.1s Y(s) + Y(s) = \sum_{k=1}^{15} e^{-(2k-1)\pi s}.$$

Solving for the transform of the solution,

$$Y(s) = \sum_{k=1}^{15} \frac{e^{-(2k-1)\pi s}}{s^2 + 0.1s + 1}.$$

As shown in Prob. 23,

$$\mathcal{L}^{-1}\left[\frac{1}{s^2 + 0.1s + 1}\right] = \frac{20}{\sqrt{399}} e^{-t/20} \sin\left(\frac{\sqrt{399}}{20} t\right).$$

Applying Theorem 6.3.1, term-by-term,

$$y(t) = \sum_{k=1}^{15} h[t - (2k - 1)\pi] u_{(2k-1)\pi}(t),$$

in which

$$h(t) = \frac{20}{\sqrt{399}} e^{-t/20} \sin\left(\frac{\sqrt{399}}{20} t\right).$$

(c).

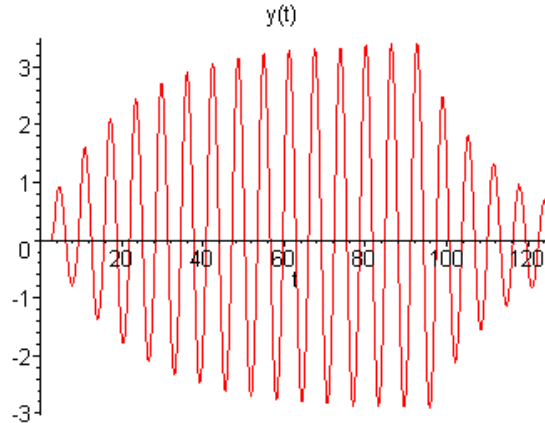

25(a). A fundamental set of solutions is  $y_1(t) = e^{-t} \cos t$  and  $y_2(t) = e^{-t} \sin t$ . Based on Prob. 22, in Section 3.7, a particular solution is given by

$$y_p(t) = \int_0^t \frac{y_1(s)y_2(t) - y_1(t)y_2(s)}{W(y_1, y_2)(s)} f(s) ds.$$

In the given problem,

$$\begin{aligned} y_p(t) &= \int_0^t \frac{e^{-s-t} [\cos(s) \sin(t) - \sin(s) \cos(t)]}{\exp(-2s)} f(s) ds. \\ &= \int_0^t e^{-(t-s)} \sin(t-s) f(s) ds. \end{aligned}$$

Given the specified initial conditions,

$$y(t) = \int_0^t e^{-(t-s)} \sin(t-s) f(s) ds.$$

(b). Let  $f(t) = \delta(t - \pi)$ . It is easy to see that if  $t < \pi$ ,  $y(t) = 0$ . If  $t > \pi$ ,

$$\int_0^t e^{-(t-s)} \sin(t-s) \delta(s - \pi) ds = e^{-(t-\pi)} \sin(t - \pi).$$

Setting  $t = \pi + \varepsilon$ , and letting  $\varepsilon \rightarrow 0$ , we find that  $y(\pi) = 0$ . Hence

$$y(t) = e^{-(t-\pi)} \sin(t - \pi) u_{\pi}(t).$$

(c). The Laplace transform of the solution is

$$\begin{aligned} Y(s) &= \frac{e^{-\pi s}}{s^2 + 2s + 2} \\ &= \frac{e^{-\pi s}}{(s + 1)^2 + 1}. \end{aligned}$$

Hence the solutions agree.

## Section 6.6

1(a). The *convolution integral* is defined as

$$f * g(t) = \int_0^t f(t - \tau)g(\tau)d\tau.$$

Consider the change of variable  $u = t - \tau$ . It follows that

$$\begin{aligned} \int_0^t f(t - \tau)g(\tau)d\tau &= \int_t^0 f(u)g(t - u)(-du) \\ &= \int_0^t g(t - u)f(u)du \\ &= g * f(t). \end{aligned}$$

(b). Based on the distributive property of the *real numbers*, the convolution is also distributive.

(c). By definition,

$$\begin{aligned} f * (g * h)(t) &= \int_0^t f(t - \tau)[g * h(\tau)]d\tau \\ &= \int_0^t f(t - \tau) \left[ \int_0^\tau g(\tau - \eta)h(\eta)d\eta \right] d\tau \\ &= \int_0^t \int_0^\tau f(t - \tau)g(\tau - \eta)h(\eta) d\eta d\tau. \end{aligned}$$

The region of integration, in the double integral is the area between the straight lines  $\eta = 0$ ,  $\eta = \tau$  and  $\tau = t$ . Interchanging the order of integration,

$$\begin{aligned} \int_0^t \int_0^\tau f(t - \tau)g(\tau - \eta)h(\eta) d\eta d\tau &= \int_0^t \int_\eta^t f(t - \tau)g(\tau - \eta)h(\eta) d\tau d\eta \\ &= \int_0^t \left[ \int_\eta^t f(t - \tau)g(\tau - \eta)d\tau \right] h(\eta) d\eta. \end{aligned}$$

Now let  $\tau - \eta = u$ . Then

$$\begin{aligned} \int_\eta^t f(t - \tau)g(\tau - \eta)d\tau &= \int_0^{t-\eta} f(t - \eta - u)g(u)du \\ &= f * g(t - \eta). \end{aligned}$$

Hence

$$\int_0^t f(t - \tau)[g * h(\tau)]d\tau = \int_0^t [f * g(t - \tau)]h(\tau) d\tau.$$

2. Let  $f(t) = e^t$ . Then

$$\begin{aligned} f * 1(t) &= \int_0^t e^{t-\tau} \cdot 1 \, d\tau \\ &= e^t \int_0^t e^{-\tau} \, d\tau \\ &= e^t - 1. \end{aligned}$$

3. It follows directly that

$$\begin{aligned} f * f(t) &= \int_0^t \sin(t-\tau) \sin(\tau) \, d\tau \\ &= \frac{1}{2} \int_0^t [\cos(t-2\tau) - \cos(t)] \, d\tau \\ &= \frac{1}{2} [\sin(t) - t \cos(t)]. \end{aligned}$$

The *range* of the resulting function is  $\mathbb{R}$ .

5. We have  $\mathcal{L}[e^{-t}] = 1/(s+1)$  and  $\mathcal{L}[\sin t] = 1/(s^2+1)$ . Based on Theorem 6.6.1,

$$\begin{aligned} \mathcal{L}\left[\int_0^t e^{-(t-\tau)} \sin(\tau) \, d\tau\right] &= \frac{1}{s+1} \cdot \frac{1}{s^2+1} \\ &= \frac{1}{(s+1)(s^2+1)}. \end{aligned}$$

6. Let  $g(t) = t$  and  $h(t) = e^t$ . Then  $f(t) = g * h(t)$ . Applying Theorem 6.6.1,

$$\begin{aligned} \mathcal{L}\left[\int_0^t g(t-\tau)h(\tau) \, d\tau\right] &= \frac{1}{s^2} \cdot \frac{1}{s-1} \\ &= \frac{1}{s^2(s-1)}. \end{aligned}$$

7. We have  $f(t) = g * h(t)$ , in which  $g(t) = \sin t$  and  $h(t) = \cos t$ . The transform of the convolution integral is

$$\begin{aligned} \mathcal{L}\left[\int_0^t g(t-\tau)h(\tau) \, d\tau\right] &= \frac{1}{s^2+1} \cdot \frac{s}{s^2+1} \\ &= \frac{s}{(s^2+1)^2}. \end{aligned}$$

9. It is easy to see that

$$\mathcal{L}^{-1}\left[\frac{1}{s+1}\right] = e^{-t} \quad \text{and} \quad \mathcal{L}^{-1}\left[\frac{s}{s^2+4}\right] = \cos 2t.$$

Applying Theorem 6.6.1,

$$\mathcal{L}^{-1}\left[\frac{s}{(s+1)(s^2+4)}\right] = \int_0^t e^{-(t-\tau)} \cos 2\tau \, d\tau.$$

10. We first note that

$$\mathcal{L}^{-1}\left[\frac{1}{(s+1)^2}\right] = t e^{-t} \quad \text{and} \quad \mathcal{L}^{-1}\left[\frac{1}{s^2+4}\right] = \frac{1}{2} \sin 2t.$$

Based on the *convolution theorem*,

$$\begin{aligned} \mathcal{L}^{-1}\left[\frac{1}{(s+1)^2(s^2+4)}\right] &= \frac{1}{2} \int_0^t (t-\tau) e^{-(t-\tau)} \sin 2\tau \, d\tau \\ &= \frac{1}{2} \int_0^t \tau e^{-\tau} \sin(2t-2\tau) \, d\tau. \end{aligned}$$

11. Let  $g(t) = \mathcal{L}^{-1}[G(s)]$ . Since  $\mathcal{L}^{-1}[1/(s^2+1)] = \sin t$ , the inverse transform of the product is

$$\begin{aligned} \mathcal{L}^{-1}\left[\frac{G(s)}{s^2+1}\right] &= \int_0^t g(t-\tau) \sin \tau \, d\tau \\ &= \int_0^t \sin(t-\tau) g(\tau) \, d\tau. \end{aligned}$$

12. Taking the initial conditions into consideration, the transform of the ODE is

$$s^2 Y(s) - 1 + \omega^2 Y(s) = G(s).$$

Solving for the transform of the solution,

$$Y(s) = \frac{1}{s^2 + \omega^2} + \frac{G(s)}{s^2 + \omega^2}.$$

As shown in a related situation, Prob. 11,

$$\mathcal{L}^{-1}\left[\frac{G(s)}{s^2 + \omega^2}\right] = \frac{1}{\omega} \int_0^t \sin \omega(t-\tau) g(\tau) \, d\tau.$$

Hence the solution of the IVP is

$$y(t) = \frac{1}{\omega} \sin \omega t + \frac{1}{\omega} \int_0^t \sin \omega(t - \tau) g(\tau) d\tau.$$

14. The transform of the ODE (given the specified initial conditions) is

$$4s^2 Y(s) + 4s Y(s) + 17 Y(s) = G(s).$$

Solving for the transform of the solution,

$$Y(s) = \frac{G(s)}{4s^2 + 4s + 17}.$$

First write

$$\frac{1}{4s^2 + 4s + 17} = \frac{\frac{1}{4}}{\left(s + \frac{1}{2}\right)^2 + 4}.$$

Based on the elementary properties of the Laplace transform,

$$\mathcal{L}^{-1}\left[\frac{1}{4s^2 + 4s + 17}\right] = \frac{1}{8} e^{-t/2} \sin 2t.$$

Applying the *convolution theorem*, the solution of the IVP is

$$y(t) = \frac{1}{8} \int_0^t e^{-(t-\tau)/2} \sin 2(t - \tau) g(\tau) d\tau.$$

16. Taking the initial conditions into consideration, the transform of the ODE is

$$s^2 Y(s) - 2s + 3 + 4[s Y(s) - 2] + 4 Y(s) = G(s).$$

Solving for the transform of the solution,

$$Y(s) = \frac{2s + 5}{(s + 2)^2} + \frac{G(s)}{(s + 2)^2}.$$

We can write

$$\frac{2s + 5}{(s + 2)^2} = \frac{2}{s + 2} + \frac{1}{(s + 2)^2}.$$

It follows that

$$\mathcal{L}^{-1}\left[\frac{2}{s + 2}\right] = 2e^{-2t} \quad \text{and} \quad \mathcal{L}^{-1}\left[\frac{1}{(s + 2)^2}\right] = t e^{-2t}.$$

Based on the *convolution theorem*, the solution of the IVP is

$$y(t) = 2e^{-2t} + te^{-2t} + \int_0^t (t - \tau)e^{-2(t-\tau)}g(\tau) d\tau.$$

18. The transform of the ODE (given the specified initial conditions) is

$$s^4 Y(s) - Y(s) = G(s).$$

Solving for the transform of the solution,

$$Y(s) = \frac{G(s)}{s^4 - 1}.$$

First write

$$\frac{1}{s^4 - 1} = \frac{1}{2} \left[ \frac{1}{s^2 - 1} - \frac{1}{s^2 + 1} \right].$$

It follows that

$$\mathcal{L}^{-1} \left[ \frac{1}{s^4 - 1} \right] = \frac{1}{2} [\sinh t - \sin t].$$

Based on the *convolution theorem*, the solution of the IVP is

$$y(t) = \frac{1}{2} \int_0^t [\sinh(t - \tau) - \sin(t - \tau)]g(\tau) d\tau.$$

19. Taking the initial conditions into consideration, the transform of the ODE is

$$s^4 Y(s) - s^3 + 5s^2 Y(s) - 5s + 4Y(s) = G(s).$$

Solving for the transform of the solution,

$$Y(s) = \frac{s^3 + 5s}{(s^2 + 1)(s^2 + 4)} + \frac{G(s)}{(s^2 + 1)(s^2 + 4)}.$$

Using partial fractions, we find that

$$\frac{s^3 + 5s}{(s^2 + 1)(s^2 + 4)} = \frac{1}{3} \left[ \frac{4s}{s^2 + 1} - \frac{s}{s^2 + 4} \right],$$

and

$$\frac{1}{(s^2 + 1)(s^2 + 4)} = \frac{1}{3} \left[ \frac{1}{s^2 + 1} - \frac{1}{s^2 + 4} \right].$$

It follows that



$$\mathcal{L}^{-1}\left[\frac{s(s^2 + 5)}{(s^2 + 1)(s^2 + 4)}\right] = \frac{4}{3} \cos t - \frac{1}{3} \cos 2t,$$

and

$$\mathcal{L}^{-1}\left[\frac{1}{(s^2 + 1)(s^2 + 4)}\right] = \frac{1}{3} \sin t - \frac{1}{6} \sin 2t.$$

Based on the *convolution theorem*, the solution of the IVP is

$$y(t) = \frac{4}{3} \cos t - \frac{1}{3} \cos 2t + \frac{1}{6} \int_0^t [2 \sin(t - \tau) - \sin 2(t - \tau)]g(\tau) d\tau.$$

21(a). Let  $\phi(t) = u''(t)$ . Substitution into the *integral equation* results in

$$u''(t) + \int_0^t (t - \xi) u''(\xi) d\xi = \sin 2t.$$

Integrating by parts,

$$\begin{aligned} \int_0^t (t - \xi) u''(\xi) d\xi &= (t - \xi) u'(\xi) \Big|_{\xi=0}^{\xi=t} + \int_0^t u'(\xi) d\xi \\ &= -t u'(0) + u(t) - u(0). \end{aligned}$$

Hence

$$u''(t) + u(t) - t u'(0) - u(0) = \sin 2t.$$

(b). Substituting the given *initial conditions* for the function  $u(t)$ ,

$$u''(t) + u(t) = \sin 2t.$$

Hence the solution of the IVP is equivalent to solving the integral equation in Part (a).

(c). Taking the Laplace transform of the integral equation, with  $\Phi(s) = \mathcal{L}[\phi(t)]$ ,

$$\Phi(s) + \frac{1}{s^2} \cdot \Phi(s) = \frac{2}{s^2 + 4}.$$

Note that the *convolution theorem* was applied. Solving for the transform  $\Phi(s)$ ,

$$\Phi(s) = \frac{2s^2}{(s^2 + 1)(s^2 + 4)}.$$

Using partial fractions, we can write

$$\frac{2s^2}{(s^2 + 1)(s^2 + 4)} = \frac{2}{3} \left[ \frac{4}{s^2 + 4} - \frac{1}{s^2 + 1} \right].$$

Therefore the solution of the *integral equation* is

$$\phi(t) = \frac{4}{3} \sin 2t - \frac{2}{3} \sin t.$$

(d). Taking the Laplace transform of the ODE, with  $U(s) = \mathcal{L}[u(t)]$ ,

$$s^2 U(s) + U(s) = \frac{2}{s^2 + 4}.$$

Solving for the transform of the solution,

$$U(s) = \frac{2}{(s^2 + 1)(s^2 + 4)}.$$

Using partial fractions, we can write

$$\frac{2}{(s^2 + 1)(s^2 + 4)} = \frac{1}{3} \left[ \frac{2}{s^2 + 1} - \frac{2}{s^2 + 4} \right].$$

It follows that the solution of the IVP is

$$u(t) = \frac{2}{3} \sin t - \frac{1}{3} \sin 2t.$$

We find that  $u''(t) = -\frac{2}{3} \sin t + \frac{4}{3} \sin 2t$ .

22(a). First note that

$$\int_0^b \frac{f(y)}{\sqrt{b-y}} dy = \left( \frac{1}{\sqrt{y}} * f \right)(b).$$

Take the Laplace transformation of both sides of the equation. Using the *convolution theorem*, with  $F(s) = \mathcal{L}[f(y)]$ ,

$$\frac{T_0}{s} = \frac{1}{\sqrt{2g}} F(s) \cdot \mathcal{L} \left[ \frac{1}{\sqrt{y}} \right].$$

It was shown in Prob. 27(c), Section 6.1, that

$$\mathcal{L} \left[ \frac{1}{\sqrt{y}} \right] = \sqrt{\frac{\pi}{s}}.$$

Hence

$$\frac{T_0}{s} = \frac{1}{\sqrt{2g}} F(s) \cdot \sqrt{\frac{\pi}{s}},$$

with

$$F(s) = \sqrt{\frac{2g}{\pi}} \cdot \frac{T_0}{\sqrt{s}}.$$

Taking the inverse transform, we obtain

$$f(y) = \frac{T_0}{\pi} \sqrt{\frac{2g}{y}}.$$

(b). Combining equations (i) and (iv),

$$\frac{2gT_0^2}{\pi^2 y} = 1 + \left(\frac{dx}{dy}\right)^2.$$

Solving for the derivative  $dx/dy$ ,

$$\frac{dx}{dy} = \sqrt{\frac{2\alpha - y}{y}},$$

in which  $\alpha = gT_0^2/\pi^2$ .

(c). Consider the *change of variable*  $y = 2\alpha \sin^2(\theta/2)$ . Using the chain rule,

$$\frac{dy}{d\theta} = 2\alpha \sin(\theta/2)\cos(\theta/2) \cdot \frac{d\theta}{d\theta}$$

and

$$\frac{dx}{d\theta} = \frac{1}{2\alpha \sin(\theta/2)\cos(\theta/2)} \cdot \frac{dx}{d\theta}.$$

It follows that

$$\begin{aligned} \frac{dx}{d\theta} &= 2\alpha \sin(\theta/2)\cos(\theta/2) \sqrt{\frac{\cos^2(\theta/2)}{\sin^2(\theta/2)}} \\ &= 2\alpha \cos^2(\theta/2) \\ &= \alpha + \alpha \cos \theta. \end{aligned}$$

Direct integration results in

$$x(\theta) = \alpha \theta + \alpha \sin \theta + C.$$

Since the curve passes through the *origin*, we require  $y(0) = x(0) = 0$ . Hence  $C = 0$ , and  $x(\theta) = \alpha \theta + \alpha \sin \theta$ . We also have

$$\begin{aligned}y(\theta) &= 2\alpha \sin^2(\theta/2) \\ &= \alpha - \alpha \cos \theta.\end{aligned}$$

## Chapter Seven

### Section 7.1

1. Introduce the variables  $x_1 = u$  and  $x_2 = u'$ . It follows that  $x_1' = x_2$  and

$$\begin{aligned} x_2' &= u'' \\ &= -2u - 0.5u'. \end{aligned}$$

In terms of the new variables, we obtain the system of two first order ODEs

$$\begin{aligned} x_1' &= x_2 \\ x_2' &= -2x_1 - 0.5x_2. \end{aligned}$$

3. First divide both sides of the equation by  $t^2$ , and write

$$u'' = -\frac{1}{t}u' - \left(1 - \frac{1}{4t^2}\right)u.$$

Set  $x_1 = u$  and  $x_2 = u'$ . It follows that  $x_1' = x_2$  and

$$\begin{aligned} x_2' &= u'' \\ &= -\frac{1}{t}u' - \left(1 - \frac{1}{4t^2}\right)u. \end{aligned}$$

We obtain the system of equations

$$\begin{aligned} x_1' &= x_2 \\ x_2' &= -\left(1 - \frac{1}{4t^2}\right)x_1 - \frac{1}{t}x_2. \end{aligned}$$

6. One of the ways to transform the system is to assign the variables

$$y_1 = x_1, \quad y_2 = x_1', \quad y_3 = x_2, \quad y_4 = x_2'.$$

Before proceeding, note that

$$\begin{aligned} x_1'' &= \frac{1}{m_1}[-(k_1 + k_2)x_1 + k_2x_2 + F_1(t)] \\ x_2'' &= \frac{1}{m_2}[k_2x_1 - (k_2 + k_3)x_2 + F_2(t)]. \end{aligned}$$

Differentiating the new variables, we obtain the system of four first order equations

$$\begin{aligned}
 y_1' &= y_2 \\
 y_2' &= \frac{1}{m_1} [ - (k_1 + k_2)y_1 + k_2y_3 + F_1(t) ] \\
 y_3' &= y_4 \\
 y_4' &= \frac{1}{m_2} [ k_2y_1 - (k_2 + k_3)y_3 + F_2(t) ].
 \end{aligned}$$

7(a). Solving the *first* equation for  $x_2$ , we have  $x_2 = x_1' + 2x_1$ . Substitution into the second equation results in

$$(x_1' + 2x_1)' = x_1 - 2(x_1' + 2x_1).$$

That is,  $x_1'' + 4x_1' + 3x_1 = 0$ . The resulting equation is a second order differential equation with *constant coefficients*. The general solution is

$$x_1(t) = c_1e^{-t} + c_2e^{-3t}.$$

With  $x_2$  given in terms of  $x_1$ , it follows that

$$x_2(t) = c_1e^{-t} - c_2e^{-3t}.$$

(b). Imposing the specified initial conditions, we obtain

$$\begin{aligned}
 c_1 + c_2 &= 2 \\
 c_1 - c_2 &= 3,
 \end{aligned}$$

with solution  $c_1 = 5/2$  and  $c_2 = -1/2$ . Hence

$$x_1(t) = \frac{5}{2}e^{-t} - \frac{1}{2}e^{-3t} \quad \text{and} \quad x_2(t) = \frac{5}{2}e^{-t} + \frac{1}{2}e^{-3t}.$$

(c).

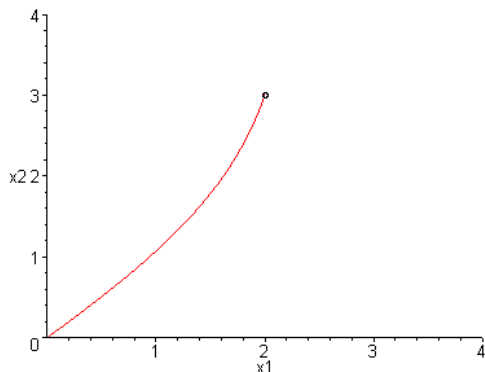

10. Solving the *first* equation for  $x_2$ , we obtain  $x_2 = (x_1 - x_1')/2$ . Substitution into

the second equation results in

$$(x_1 - x_1')/2 = 3x_1 - 2(x_1 - x_1').$$

Rearranging the terms, the single differential equation for  $x_1$  is

$$x_1'' + 3x_1' + 2x_1 = 0.$$

The general solution is

$$x_1(t) = c_1e^{-t} + c_2e^{-2t}.$$

With  $x_2$  given in terms of  $x_1$ , it follows that

$$x_2(t) = c_1e^{-t} + \frac{3}{2}c_2e^{-3t}.$$

Invoking the specified *initial conditions*,  $c_1 = -7$  and  $c_2 = 6$ . Hence

$$x_1(t) = -7e^{-t} + 6e^{-2t} \text{ and } x_2(t) = -7e^{-t} + 9e^{-3t}.$$

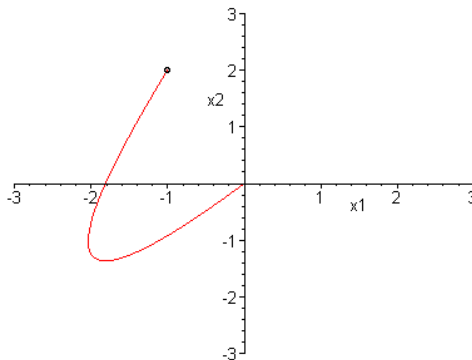

11. Solving the *first* equation for  $x_2$ , we have  $x_2 = x_1'/2$ . Substitution into the second equation results in

$$x_1''/2 = -2x_1.$$

The resulting equation is  $x_1'' + 4x_1 = 0$ , with general solution

$$x_1(t) = c_1\cos 2t + c_2\sin 2t.$$

With  $x_2$  given in terms of  $x_1$ , it follows that

$$x_2(t) = -c_1\sin 2t + c_2\cos 2t.$$

Imposing the specified initial conditions, we obtain  $c_1 = 3$  and  $c_2 = 4$ . Hence

$$x_1(t) = 3\cos 2t + 4\sin 2t \text{ and } x_2(t) = -3\sin 2t + 4\cos 2t.$$

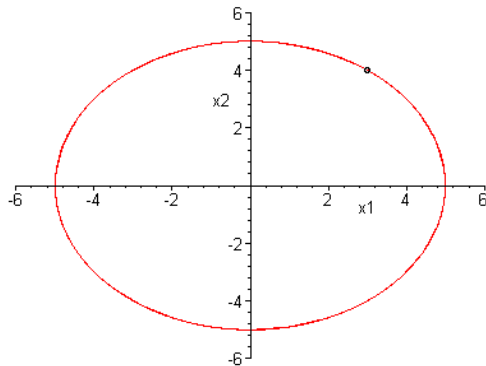

12. Solving the *first* equation for  $x_2$ , we obtain  $x_2 = x_1'/2 + x_1/4$ . Substitution into the second equation results in

$$x_1''/2 + x_1'/4 = -2x_1 - (x_1'/2 + x_1/4)/2.$$

Rearranging the terms, the single differential equation for  $x_1$  is

$$x_1'' + x_1' + \frac{17}{4}x_1 = 0.$$

The general solution is

$$x_1(t) = e^{-t/2}[c_1 \cos 2t + c_2 \sin 2t].$$

With  $x_2$  given in terms of  $x_1$ , it follows that

$$x_2(t) = e^{-t/2}[-c_1 \cos 2t + c_2 \sin 2t].$$

Imposing the specified initial conditions, we obtain  $c_1 = -2$  and  $c_2 = 2$ . Hence

$$x_1(t) = e^{-t/2}[-2 \cos 2t + 2 \sin 2t] \text{ and } x_2(t) = e^{-t/2}[2 \cos 2t + 2 \sin 2t].$$

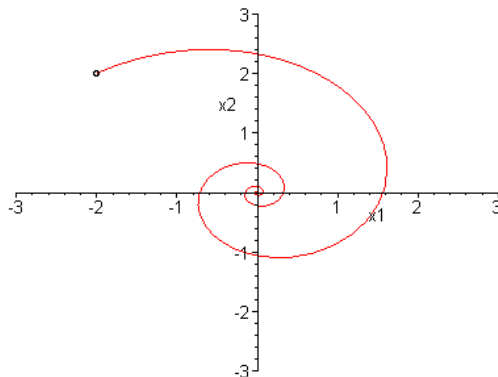

13. Solving the *first* equation for  $V$ , we obtain  $V = L \cdot I'$ . Substitution into the second equation results in



$$L \cdot I'' = -\frac{I}{C} - \frac{L}{RC}I'.$$

Rearranging the terms, the single differential equation for  $I$  is

$$LRC \cdot I'' + L \cdot I' + R \cdot I = 0.$$

15. Direct substitution results in

$$\begin{aligned} (c_1x_1(t) + c_2x_2(t))' &= p_{11}(t)[c_1x_1(t) + c_2x_2(t)] + p_{12}(t)[c_1y_1(t) + c_2y_2(t)] \\ (c_1y_1(t) + c_2y_2(t))' &= p_{21}(t)[c_1x_1(t) + c_2x_2(t)] + p_{22}(t)[c_1y_1(t) + c_2y_2(t)]. \end{aligned}$$

Expanding the left-hand-side of the *first* equation,

$$\begin{aligned} c_1x_1'(t) + c_2x_2'(t) &= c_1[p_{11}(t)x_1(t) + p_{12}(t)y_1(t)] + \\ &+ c_2[p_{11}(t)x_2(t) + p_{12}(t)y_2(t)]. \end{aligned}$$

Repeat with the second equation to show that the system of ODEs is identically satisfied.

16. Based on the hypothesis,

$$\begin{aligned} x_1'(t) &= p_{11}(t)x_1(t) + p_{12}(t)y_1(t) + g_1(t) \\ x_2'(t) &= p_{11}(t)x_2(t) + p_{12}(t)y_2(t) + g_1(t). \end{aligned}$$

Subtracting the two equations,

$$x_1'(t) - x_2'(t) = p_{11}(t)[x_1'(t) - x_2'(t)] + p_{12}(t)[y_1'(t) - y_2'(t)].$$

Similarly,

$$y_1'(t) - y_2'(t) = p_{21}(t)[x_1'(t) - x_2'(t)] + p_{22}(t)[y_1'(t) - y_2'(t)].$$

Hence the *difference* of the two solutions satisfies the *homogeneous* ODE.

17. For *rectilinear motion* in one dimension, Newton's second law can be stated as

$$\sum F = m x''.$$

The *resisting* force exerted by a linear spring is given by  $F_s = k \delta$ , in which  $\delta$  is the *displacement* of the end of a spring from its equilibrium configuration. Hence, with  $0 < x_1 < x_2$ , the first two springs are in *tension*, and the last spring is in *compression*. The *sum* of the spring forces on  $m_1$  is

$$F_s^1 = -k_1x_1 - k_2(x_2 - x_1).$$

The *total* force on  $m_1$  is

$$\sum F^1 = -k_1 x_1 + k_2(x_2 - x_1) + F_1(t).$$

Similarly, the *total* force on  $m_2$  is

$$\sum F^2 = -k_2(x_2 - x_1) - k_3 x_2 + F_2(t).$$

18(a). Taking a *clockwise* loop around each of the paths, it is easy to see that voltage drops are given by  $V_1 - V_2 = 0$ , and  $V_2 - V_3 = 0$ .

(b). Consider the *right node*. The *current in* is given by  $I_1 + I_2$ . The current *leaving* the node is  $-I_3$ . Hence the current passing through the node is  $(I_1 + I_2) - (-I_3)$ . Based on Kirchhoff's first law,  $I_1 + I_2 + I_3 = 0$ .

(c). In the capacitor,

$$C V_1' = I_1.$$

In the resistor,

$$V_2 = R I_2.$$

In the inductor,

$$L I_3' = V_3.$$

(d). Based on part (a),  $V_3 = V_2 = V_1$ . Based on part (b),

$$C V_1' + \frac{1}{R} V_2 + I_3 = 0.$$

It follows that

$$C V_1' = -\frac{1}{R} V_1 - I_3 \quad \text{and} \quad L I_3' = V_1.$$

20. Let  $I_1, I_2, I_3$ , and  $I_4$  be the current through the resistors, inductor, and capacitor, respectively. Assign  $V_1, V_2, V_3$ , and  $V_4$  as the respective voltage drops. Based on Kirchhoff's second law, the net voltage drops, around each loop, satisfy

$$V_1 + V_3 + V_4 = 0, \quad V_1 + V_3 + V_2 = 0 \quad \text{and} \quad V_4 - V_2 = 0.$$

Applying Kirchhoff's first law to the upper-right node,

$$I_3 - (I_2 + I_4) = 0.$$

Likewise, in the remaining nodes,

$$I_1 - I_3 = 0 \text{ and } I_2 + I_4 - I_1 = 0.$$

That is,

$$V_4 - V_2 = 0, \quad V_1 + V_3 + V_4 = 0 \text{ and } I_2 + I_4 - I_3 = 0.$$

Using the current-voltage relations,

$$V_1 = R_1 I_1, \quad V_2 = R_2 I_2, \quad L I_3' = V_3, \quad C V_4' = I_4.$$

Combining these equations,

$$R_1 I_3 + L I_3' + V_4 = 0 \text{ and } C V_4' = I_3 - \frac{V_4}{R_2}.$$

Now set  $I_3 = I$  and  $V_4 = V$ , to obtain the system of equations

$$L I' = -R_1 I - V \text{ and } C V' = I - \frac{V}{R_2}.$$

22(a).

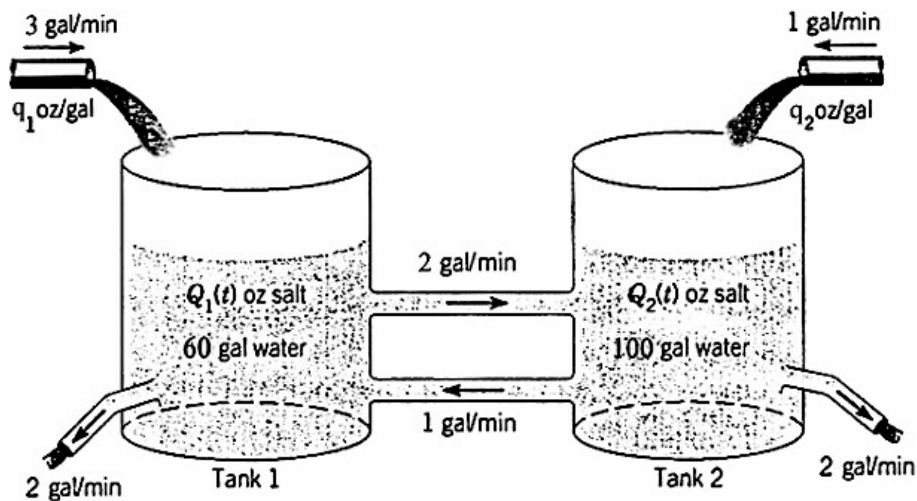

Let  $Q_1(t)$  and  $Q_2(t)$  be the *amount* of salt in the respective tanks at time  $t$ . Note that the *volume* of each tank remains constant. Based on conservation of mass, the *rate of increase* of salt, in any given tank, is given by

$$\text{rate of increase} = \text{rate in} - \text{rate out}.$$

For Tank 1, the rate of salt flowing *into* Tank 1 is

$$\begin{aligned} r_{in} &= \left[ q_1 \frac{\text{oz}}{\text{gal}} \right] \left[ 3 \frac{\text{gal}}{\text{min}} \right] + \left[ \frac{Q_2}{100} \frac{\text{oz}}{\text{gal}} \right] \left[ 1 \frac{\text{gal}}{\text{min}} \right] \\ &= 3 q_1 + \frac{Q_2}{100} \frac{\text{oz}}{\text{min}}. \end{aligned}$$

The rate at which salt flow *out* of Tank 1 is

$$r_{out} = \left[ \frac{Q_1}{60} \frac{\text{oz}}{\text{gal}} \right] \left[ 4 \frac{\text{gal}}{\text{min}} \right] = \frac{Q_1}{15} \frac{\text{oz}}{\text{min}}.$$

Hence

$$\frac{dQ_1}{dt} = 3 q_1 + \frac{Q_2}{100} - \frac{Q_1}{15}.$$

Similarly, for Tank 2,

$$\frac{dQ_2}{dt} = q_2 + \frac{Q_1}{30} - \frac{3Q_2}{100}.$$

The process is modeled by the system of equations

$$\begin{aligned} Q_1' &= -\frac{Q_1}{15} + \frac{Q_2}{100} + 3 q_1 \\ Q_2' &= \frac{Q_1}{30} - \frac{3Q_2}{100} + q_2. \end{aligned}$$

The initial conditions are  $Q_1(0) = Q_1^0$  and  $Q_2(0) = Q_2^0$ .

(b). The *equilibrium values* are obtain by solving the system

$$\begin{aligned} -\frac{Q_1}{15} + \frac{Q_2}{100} + 3 q_1 &= 0 \\ \frac{Q_1}{30} - \frac{3Q_2}{100} + q_2 &= 0. \end{aligned}$$

Its solution leads to  $Q_1^E = 54 q_1 + 6 q_2$  and  $Q_2^E = 60 q_1 + 40 q_2$ .

(c). The question refers to possible solution of the system

$$\begin{aligned} 54 q_1 + 6 q_2 &= 60 \\ 60 q_1 + 40 q_2 &= 50. \end{aligned}$$

It is possible for formally solve the system of equations, but the unique solution gives

$$q_1 = \frac{7}{6} \frac{\text{oz}}{\text{gal}} \quad \text{and} \quad q_2 = -\frac{1}{2} \frac{\text{oz}}{\text{gal}},$$

which is *not* physically possible.

(d). We can write

$$q_2 = -9q_1 + \frac{Q_1^E}{6}$$

$$q_2 = -\frac{3}{2}q_1 + \frac{Q_2^E}{40},$$

which are the equations of two lines in the  $q_1q_2$ -plane:

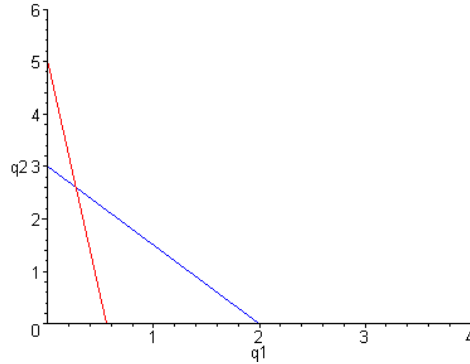

The intercepts of the *first* line are  $Q_1^E/54$  and  $Q_1^E/6$ . The intercepts of the *second* line are  $Q_2^E/60$  and  $Q_2^E/40$ . Therefore the system will have a unique solution, in the *first quadrant*, as long as  $Q_1^E/54 \leq Q_2^E/60$  or  $Q_2^E/40 \leq Q_1^E/6$ . That is,

$$\frac{10}{9} \leq \frac{Q_2^E}{Q_1^E} \leq \frac{20}{3}.$$

## Section 7.2

2(a).

$$\mathbf{A} - 2\mathbf{B} = \begin{pmatrix} 1+i-2i & -1+2i-6 \\ 3+2i-4 & 2-i+4i \end{pmatrix} = \begin{pmatrix} 1-i & -7+2i \\ -1+2i & 2+3i \end{pmatrix}.$$

(b).

$$3\mathbf{A} + \mathbf{B} = \begin{pmatrix} 3+3i+i & -3+6i+3 \\ 9+6i+2 & 6-3i-2i \end{pmatrix} = \begin{pmatrix} 3+4i & 6i \\ 11+6i & 6-5i \end{pmatrix}.$$

(c).

$$\begin{aligned} \mathbf{AB} &= \begin{pmatrix} (1+i)i+2(-1+2i) & 3(1+i)+(-1+2i)(-2i) \\ (3+2i)i+2(2-i) & 3(3+2i)+(2-i)(-2i) \end{pmatrix} \\ &= \begin{pmatrix} -3+5i & 7+5i \\ 2+i & 7+2i \end{pmatrix}. \end{aligned}$$

(d).

$$\begin{aligned} \mathbf{BA} &= \begin{pmatrix} (1+i)i+3(3+2i) & (-1+2i)i+3(2-i) \\ 2(1+i)+(-2i)(3+2i) & 2(-1+2i)+(-2i)(2-i) \end{pmatrix} \\ &= \begin{pmatrix} 8+7i & 4-4i \\ 6-4i & -4 \end{pmatrix}. \end{aligned}$$

3.

$$\begin{aligned} \mathbf{A}^T + \mathbf{B}^T &= \begin{pmatrix} -2 & 1 & 2 \\ 1 & 0 & -1 \\ 2 & -3 & 1 \end{pmatrix} + \begin{pmatrix} 1 & 3 & -2 \\ 2 & -1 & 1 \\ 3 & -1 & 0 \end{pmatrix} \\ &= \begin{pmatrix} -1 & 4 & 0 \\ 3 & -1 & 0 \\ 5 & -4 & 1 \end{pmatrix} \\ &= (\mathbf{A} + \mathbf{B})^T. \end{aligned}$$

4(b).

$$\bar{\mathbf{A}} = \begin{pmatrix} 3+2i & 1-i \\ 2+i & -2-3i \end{pmatrix}.$$

(c). By definition,  $\mathbf{A}^* = (\bar{\mathbf{A}}^T) = (\bar{\mathbf{A}})^T$ .

5.

$$2(\mathbf{A} + \mathbf{B}) = 2 \begin{pmatrix} 5 & 3 & -2 \\ 0 & 2 & 5 \\ 1 & 2 & 3 \end{pmatrix} = \begin{pmatrix} 10 & 6 & -4 \\ 0 & 4 & 10 \\ 2 & 4 & 6 \end{pmatrix}.$$

7. Let  $\mathbf{A} = (a_{ij})$  and  $\mathbf{B} = (b_{ij})$ . The given operations in (a) – (d) are performed elementwise. That is,

- (a).  $a_{ij} + b_{ij} = b_{ij} + a_{ij}$ .  
 (b).  $a_{ij} + (b_{ij} + c_{ij}) = (a_{ij} + b_{ij}) + c_{ij}$ .  
 (c).  $\alpha(a_{ij} + b_{ij}) = \alpha a_{ij} + \alpha b_{ij}$ .  
 (d).  $(\alpha + \beta) a_{ij} = \alpha a_{ij} + \beta a_{ij}$ .

In the following, let  $\mathbf{A} = (a_{ij})$ ,  $\mathbf{B} = (b_{ij})$  and  $\mathbf{C} = (c_{ij})$ .

(e). Calculating the generic element,

$$(\mathbf{BC})_{ij} = \sum_{k=1}^n b_{ik} c_{kj}.$$

Therefore

$$\begin{aligned} [\mathbf{A}(\mathbf{BC})]_{ij} &= \sum_{r=1}^n a_{ir} \left( \sum_{k=1}^n b_{rk} c_{kj} \right) \\ &= \sum_{r=1}^n \sum_{k=1}^n a_{ir} b_{rk} c_{kj} \\ &= \sum_{k=1}^n \left[ \left( \sum_{r=1}^n a_{ir} b_{rk} \right) c_{kj} \right]. \end{aligned}$$

The last summation is recognized as

$$\sum_{r=1}^n a_{ir} b_{rk} = (\mathbf{AB})_{ik},$$

which is the  $ik$ -th element of the matrix  $\mathbf{AB}$ .

(f). Likewise,

$$\begin{aligned}
[\mathbf{A}(\mathbf{B} + \mathbf{C})]_{ij} &= \sum_{k=1}^n a_{ik}(b_{kj} + c_{kj}) \\
&= \sum_{k=1}^n a_{ik} b_{kj} + \sum_{k=1}^n a_{ik} c_{kj} \\
&= (\mathbf{AB})_{ij} + (\mathbf{AC})_{ij}.
\end{aligned}$$

8(a).  $\mathbf{x}^T \mathbf{y} = 2(-1 + i) + 2(3i) + (1 - i)(3 - i) = 4i.$

(b).  $\mathbf{y}^T \mathbf{y} = (-1 + i)^2 + 2^2 + (3 - i)^2 = 12 - 8i.$

(c).  $(\mathbf{x}, \mathbf{y}) = 2(-1 - i) + 2(3i) + (1 - i)(3 + i) = 2 + 2i.$

(d).  $(\mathbf{y}, \mathbf{y}) = (-1 + i)(-1 - i) + 2^2 + (3 - i)(3 + i) = 16.$

9. Indeed,

$$\mathbf{x}^T \mathbf{y} = \sum_{j=1}^n x_j y_j = \mathbf{y}^T \mathbf{x},$$

and

$$(\mathbf{x}, \mathbf{y}) = \sum_{j=1}^n x_j \bar{y}_j = \sum_{j=1}^n \bar{y}_j x_j = \overline{\sum_{j=1}^n y_j \bar{x}_j} = \overline{(\mathbf{y}, \mathbf{x})}.$$

11. First *augment* the given matrix by the identity matrix:

$$[\mathbf{A} | \mathbf{I}] = \begin{pmatrix} 3 & -1 & 1 & 0 \\ 6 & 2 & 0 & 1 \end{pmatrix}.$$

Divide the *first row* by 3, to obtain

$$\begin{pmatrix} 1 & -\frac{1}{3} & \frac{1}{3} & 0 \\ 6 & 2 & 0 & 1 \end{pmatrix}.$$

Adding  $-6$  times the *first row* to the *second row* results in

$$\begin{pmatrix} 1 & -\frac{1}{3} & \frac{1}{3} & 0 \\ 0 & 4 & -2 & 1 \end{pmatrix}.$$

Divide the *second row* by 4, to obtain

$$\begin{pmatrix} 1 & -\frac{1}{3} & \frac{1}{3} & 0 \\ 0 & 1 & -\frac{1}{2} & \frac{1}{4} \end{pmatrix}.$$

Finally, adding  $1/3$  times the *second row* to the *first row* results in



$$\begin{pmatrix} 1 & 0 & \frac{1}{6} & \frac{1}{12} \\ 0 & 1 & -\frac{1}{2} & \frac{1}{4} \end{pmatrix}.$$

Hence

$$\begin{pmatrix} 3 & -1 \\ 6 & 2 \end{pmatrix}^{-1} = \frac{1}{12} \begin{pmatrix} 2 & 1 \\ -6 & 3 \end{pmatrix}.$$

13. The augmented matrix is

$$\begin{pmatrix} 1 & 1 & -1 & 1 & 0 & 0 \\ 2 & -1 & 1 & 0 & 1 & 0 \\ 1 & 1 & 2 & 0 & 0 & 1 \end{pmatrix}.$$

Combining the elements of the *first row* with the elements of the *second* and *third* rows results in

$$\begin{pmatrix} 1 & 1 & -1 & 1 & 0 & 0 \\ 0 & -3 & 3 & -2 & 1 & 0 \\ 0 & 0 & 3 & -1 & 0 & 1 \end{pmatrix}.$$

Divide the elements of the *second row* by  $-3$ , and the elements of the *third row* by  $3$ . Now subtracting the new *second row* from the *first row* yields

$$\begin{pmatrix} 1 & 0 & 0 & \frac{1}{3} & \frac{1}{3} & 0 \\ 0 & 1 & -1 & \frac{2}{3} & -\frac{1}{3} & 0 \\ 0 & 0 & 1 & -\frac{1}{3} & 0 & \frac{1}{3} \end{pmatrix}.$$

Finally, combine the *third row* with the *second row* to obtain

$$\begin{pmatrix} 1 & 0 & 0 & \frac{1}{3} & \frac{1}{3} & 0 \\ 0 & 1 & 0 & \frac{1}{3} & -\frac{1}{3} & \frac{1}{3} \\ 0 & 0 & 1 & -\frac{1}{3} & 0 & \frac{1}{3} \end{pmatrix}.$$

Hence

$$\begin{pmatrix} 1 & 1 & -1 \\ 2 & -1 & 1 \\ 1 & 1 & 2 \end{pmatrix}^{-1} = \frac{1}{3} \begin{pmatrix} 1 & 1 & 0 \\ 1 & -1 & 1 \\ -1 & 0 & 1 \end{pmatrix}.$$

15. Elementary row operations yield

$$\begin{pmatrix} 2 & 1 & 0 & 1 & 0 & 0 \\ 0 & 2 & 1 & 0 & 1 & 0 \\ 0 & 0 & 2 & 0 & 0 & 1 \end{pmatrix} \rightarrow \begin{pmatrix} 1 & \frac{1}{2} & 0 & \frac{1}{2} & 0 & 0 \\ 0 & 1 & \frac{1}{2} & 0 & \frac{1}{2} & 0 \\ 0 & 0 & 1 & 0 & 0 & \frac{1}{2} \end{pmatrix} \rightarrow$$

$$\begin{pmatrix} 1 & 0 & -\frac{1}{4} & \frac{1}{2} & -\frac{1}{4} & 0 \\ 0 & 1 & 0 & 0 & \frac{1}{2} & -\frac{1}{4} \\ 0 & 0 & 1 & 0 & 0 & \frac{1}{2} \end{pmatrix} \rightarrow \begin{pmatrix} 1 & 0 & -\frac{1}{4} & \frac{1}{2} & -\frac{1}{4} & 0 \\ 0 & 1 & 0 & 0 & \frac{1}{2} & -\frac{1}{4} \\ 0 & 0 & 1 & 0 & 0 & \frac{1}{2} \end{pmatrix}.$$

Finally, combining the *first* and *third* rows results in

$$\begin{pmatrix} 1 & 0 & 0 & \frac{1}{2} & -\frac{1}{4} & \frac{1}{8} \\ 0 & 1 & 0 & 0 & \frac{1}{2} & -\frac{1}{4} \\ 0 & 0 & 1 & 0 & 0 & \frac{1}{2} \end{pmatrix}.$$

16. Elementary row operations yield

$$\begin{pmatrix} 1 & -1 & -1 & 1 & 0 & 0 \\ 2 & 1 & 0 & 0 & 1 & 0 \\ 3 & -2 & 1 & 0 & 0 & 1 \end{pmatrix} \rightarrow \begin{pmatrix} 1 & -1 & -1 & 1 & 0 & 0 \\ 0 & 3 & 2 & -2 & 1 & 0 \\ 0 & 1 & 4 & -3 & 0 & 1 \end{pmatrix} \rightarrow$$

$$\begin{pmatrix} 1 & 0 & -\frac{1}{3} & \frac{1}{3} & \frac{1}{3} & 0 \\ 0 & 1 & \frac{2}{3} & -\frac{2}{3} & \frac{1}{3} & 0 \\ 0 & 0 & \frac{10}{3} & -\frac{7}{3} & -\frac{1}{3} & 1 \end{pmatrix} \rightarrow \begin{pmatrix} 1 & 0 & 0 & \frac{1}{10} & \frac{3}{10} & \frac{1}{10} \\ 0 & 1 & 0 & -\frac{3}{15} & \frac{2}{5} & -\frac{1}{5} \\ 0 & 0 & \frac{10}{3} & -\frac{7}{3} & -\frac{1}{3} & 1 \end{pmatrix}.$$

Finally, normalizing the *last* row results in

$$\begin{pmatrix} 1 & 0 & 0 & \frac{1}{10} & \frac{3}{10} & \frac{1}{10} \\ 0 & 1 & 0 & -\frac{3}{15} & \frac{2}{5} & -\frac{1}{5} \\ 0 & 0 & 1 & -\frac{7}{10} & -\frac{1}{10} & \frac{3}{10} \end{pmatrix}.$$

17. Elementary row operations on the augmented matrix yield the row-reduced form of the augmented matrix

$$\begin{pmatrix} 1 & 0 & -\frac{1}{7} & 0 & \frac{1}{7} & \frac{2}{7} \\ 0 & 1 & \frac{3}{7} & 0 & \frac{4}{7} & \frac{1}{7} \\ 0 & 0 & 0 & 1 & -2 & -1 \end{pmatrix}.$$

The *left submatrix* cannot be converted to the identity matrix. Hence the given matrix is singular.

18. Elementary row operations on the augmented matrix yield

$$\begin{pmatrix} 1 & 0 & 0 & -1 & 1 & 0 & 0 & 0 \\ 0 & -1 & 1 & 0 & 0 & 1 & 0 & 0 \\ -1 & 0 & 1 & 0 & 0 & 0 & 1 & 0 \\ 0 & 1 & -1 & 1 & 0 & 0 & 0 & 1 \end{pmatrix} \rightarrow \begin{pmatrix} 1 & 0 & 0 & -1 & 1 & 0 & 0 & 0 \\ 0 & -1 & 1 & 0 & 0 & 1 & 0 & 0 \\ 0 & 0 & 1 & -1 & 1 & 0 & 1 & 0 \\ 0 & 1 & -1 & 1 & 0 & 0 & 0 & 1 \end{pmatrix} \rightarrow$$

$$\begin{pmatrix} 1 & 0 & 0 & -1 & 1 & 0 & 0 & 0 \\ 0 & 1 & -1 & 0 & 0 & -1 & 0 & 0 \\ 0 & 0 & 1 & -1 & 1 & 0 & 1 & 0 \\ 0 & 0 & 0 & 1 & 0 & 1 & 0 & 1 \end{pmatrix} \rightarrow \begin{pmatrix} 1 & 0 & 0 & 0 & 1 & 1 & 0 & 1 \\ 0 & 1 & 0 & 0 & 1 & 0 & 1 & 1 \\ 0 & 0 & 1 & 0 & 1 & 1 & 1 & 1 \\ 0 & 0 & 0 & 1 & 0 & 1 & 0 & 1 \end{pmatrix}.$$

19. Elementary row operations on the augmented matrix yield

$$\begin{pmatrix} 1 & -1 & 2 & 0 & 1 & 0 & 0 & 0 \\ -1 & 2 & -4 & 2 & 0 & 1 & 0 & 0 \\ 1 & 0 & 1 & 3 & 0 & 0 & 1 & 0 \\ -2 & 2 & 0 & -1 & 0 & 0 & 0 & 1 \end{pmatrix} \rightarrow \begin{pmatrix} 1 & -1 & 2 & 0 & 1 & 0 & 0 & 0 \\ 0 & 1 & -2 & 2 & 1 & 1 & 0 & 0 \\ 0 & 1 & -1 & 3 & -1 & 0 & 1 & 0 \\ 0 & 0 & 4 & -1 & 2 & 0 & 0 & 1 \end{pmatrix} \rightarrow$$

$$\begin{pmatrix} 1 & 0 & 0 & 2 & 2 & 1 & 0 & 0 \\ 0 & 1 & -2 & 2 & 1 & 1 & 0 & 0 \\ 0 & 0 & 1 & 1 & -2 & -1 & 1 & 0 \\ 0 & 0 & 4 & -1 & 2 & 0 & 0 & 1 \end{pmatrix} \rightarrow \begin{pmatrix} 1 & 0 & 0 & 2 & 2 & 1 & 0 & 0 \\ 0 & 1 & 0 & 4 & -3 & -1 & 2 & 0 \\ 0 & 0 & 1 & 1 & -2 & -1 & 1 & 0 \\ 0 & 0 & 0 & -5 & 10 & 4 & -4 & 1 \end{pmatrix}.$$

Normalizing the *last row* and combining it with the others results in

$$\begin{pmatrix} 1 & 0 & 0 & 2 & 2 & 1 & 0 & 0 \\ 0 & 1 & 0 & 4 & -3 & -1 & 2 & 0 \\ 0 & 0 & 1 & 1 & -2 & -1 & 1 & 0 \\ 0 & 0 & 0 & 1 & -2 & -\frac{4}{5} & \frac{4}{5} & -\frac{1}{5} \end{pmatrix} \rightarrow \begin{pmatrix} 1 & 0 & 0 & 0 & 6 & \frac{13}{5} & -\frac{8}{5} & \frac{2}{5} \\ 0 & 1 & 0 & 0 & 5 & \frac{11}{5} & -\frac{6}{5} & \frac{4}{5} \\ 0 & 0 & 1 & 0 & 0 & -\frac{1}{5} & \frac{1}{5} & \frac{1}{5} \\ 0 & 0 & 0 & 1 & -2 & -\frac{4}{5} & \frac{4}{5} & -\frac{1}{5} \end{pmatrix}.$$

20. Suppose that  $\mathbf{A}$  is *nonsingular*, and that there exist matrices  $\mathbf{B}$  and  $\mathbf{C}$ , such that  $\mathbf{AB} = \mathbf{I}$  and  $\mathbf{AC} = \mathbf{I}$ . Based on the properties of matrices, it follows that

$$\mathbf{A}(\mathbf{B} - \mathbf{C}) = \mathbf{AY} = \mathbf{0}_{n \times n}.$$

Write the *difference* of the two matrices,  $\mathbf{Y}$ , in terms of its *columns* as

$$\mathbf{Y} = [\mathbf{y}^1 | \mathbf{y}^2 | \cdots | \mathbf{y}^n].$$

The  $j$ -th column of the product matrix,  $\mathbf{AY}$ , can be expressed as  $\mathbf{A}\mathbf{y}^j$ . Now since *all* columns of the product matrix consist only of *zeros*, we end up with  $n$  homogeneous systems of linear equations

$$\mathbf{A}\mathbf{y}^j = \mathbf{0}_{n \times 1}, \quad j = 1, 2, \dots, n.$$

Since  $\mathbf{A}$  is *nonsingular*, each system must have a *trivial solution*. That is,  $\mathbf{y}^j = \mathbf{0}_{n \times 1}$ , for  $j = 1, 2, \dots, n$ . Hence  $\mathbf{Y} = \mathbf{0}_{n \times n}$  and  $\mathbf{B} = \mathbf{C}$ .

21(a).

$$\begin{aligned}\mathbf{A} + 3\mathbf{B} &= \begin{pmatrix} e^t & 2e^{-t} & e^{2t} \\ 2e^t & e^{-t} & -e^{2t} \\ -e^t & 3e^{-t} & 2e^{2t} \end{pmatrix} + \begin{pmatrix} 6e^t & 3e^{-t} & 9e^{2t} \\ -3e^t & 6e^{-t} & 3e^{2t} \\ 9e^t & -3e^{-t} & -3e^{2t} \end{pmatrix} \\ &= \begin{pmatrix} 7e^t & 5e^{-t} & 10e^{2t} \\ -e^t & 7e^{-t} & 2e^{2t} \\ 8e^t & 0 & -e^{2t} \end{pmatrix}.\end{aligned}$$

(b). Based on the standard definition of *matrix multiplication*,

$$\mathbf{AB} = \begin{pmatrix} 2e^{2t} - 2 + 3e^{3t} & 1 + 4e^{-2t} - e^t & 3e^{3t} + 2e^t - e^{4t} \\ 4e^{2t} - 1 - 3e^{3t} & 2 + 2e^{-2t} + e^t & 6e^{3t} + e^t + e^{4t} \\ -2e^{2t} - 3 + 6e^{3t} & -1 + 6e^{-2t} - 2e^t & -3e^{3t} + 3e^t - 2e^{4t} \end{pmatrix}.$$

(c).

$$\frac{d\mathbf{A}}{dt} = \begin{pmatrix} e^t & -2e^{-t} & 2e^{2t} \\ 2e^t & -e^{-t} & -2e^{2t} \\ -e^t & -3e^{-t} & 4e^{2t} \end{pmatrix}.$$

(d). Note that

$$\int \mathbf{A}(t)dt = \begin{pmatrix} e^t & -2e^{-t} & e^{2t}/2 \\ 2e^t & -e^{-t} & -e^{2t}/2 \\ -e^t & -3e^{-t} & e^{2t} \end{pmatrix} + \mathbf{C}.$$

Therefore

$$\begin{aligned}\int_0^1 \mathbf{A}(t)dt &= \begin{pmatrix} e & -2e^{-1} & e^2/2 \\ 2e & -e^{-1} & -e^2/2 \\ -e & -3e^{-1} & e^2 \end{pmatrix} - \begin{pmatrix} 1 & -2 & 1/2 \\ 2 & -1 & -1/2 \\ -1 & -3 & 1 \end{pmatrix} \\ &= \begin{pmatrix} e-1 & 2-2e^{-1} & e^2/2-1/2 \\ 2e-2 & 1-e^{-1} & 1/2-e^2/2 \\ 1-e & 3-3e^{-1} & e^2-1 \end{pmatrix}.\end{aligned}$$

The result can also be written as

$$(e-1) \begin{pmatrix} 1 & \frac{2}{e} & \frac{1}{2}(e+1) \\ 2 & \frac{1}{e} & -\frac{1}{2}(e+1) \\ -1 & \frac{3}{e} & e+1 \end{pmatrix}.$$

23. First note that

$$\mathbf{x}' = \begin{pmatrix} 1 \\ 0 \end{pmatrix} e^t + 2 \begin{pmatrix} 1 \\ 1 \end{pmatrix} (e^t + t e^t) = \begin{pmatrix} 3e^t + 2t e^t \\ 2e^t + 2t e^t \end{pmatrix}.$$

We also have

$$\begin{aligned} \begin{pmatrix} 2 & -1 \\ 3 & -2 \end{pmatrix} \mathbf{x} &= \begin{pmatrix} 2 & -1 \\ 3 & -2 \end{pmatrix} \begin{pmatrix} 1 \\ 0 \end{pmatrix} e^t + \begin{pmatrix} 2 & -1 \\ 3 & -2 \end{pmatrix} \begin{pmatrix} 2 \\ 2 \end{pmatrix} (t e^t) \\ &= \begin{pmatrix} 2 \\ 3 \end{pmatrix} e^t + \begin{pmatrix} 2 \\ 2 \end{pmatrix} (t e^t) \\ &= \begin{pmatrix} 2e^t + 2t e^t \\ 3e^t + 2t e^t \end{pmatrix}. \end{aligned}$$

It follows that

$$\begin{pmatrix} 2 & -1 \\ 3 & -2 \end{pmatrix} \mathbf{x} + \begin{pmatrix} 1 \\ -1 \end{pmatrix} e^t = \begin{pmatrix} 3e^t + 2t e^t \\ 2e^t + 2t e^t \end{pmatrix}.$$

24. It is easy to see that

$$\mathbf{x}' = \begin{pmatrix} -6 \\ 8 \\ 4 \end{pmatrix} e^{-t} + \begin{pmatrix} 0 \\ 4 \\ -4 \end{pmatrix} e^{2t} = \begin{pmatrix} -6e^{-t} \\ 8e^{-t} + 4e^{2t} \\ 4e^{-t} - 4e^{2t} \end{pmatrix}.$$

On the other hand,

$$\begin{aligned} \begin{pmatrix} 1 & 1 & 1 \\ 2 & 1 & -1 \\ 0 & -1 & 1 \end{pmatrix} \mathbf{x} &= \begin{pmatrix} 1 & 1 & 1 \\ 2 & 1 & -1 \\ 0 & -1 & 1 \end{pmatrix} \begin{pmatrix} 6 \\ -8 \\ -4 \end{pmatrix} e^{-t} + \begin{pmatrix} 1 & 1 & 1 \\ 2 & 1 & -1 \\ 0 & -1 & 1 \end{pmatrix} \begin{pmatrix} 0 \\ 2 \\ -2 \end{pmatrix} e^{2t} \\ &= \begin{pmatrix} -6 \\ 8 \\ 4 \end{pmatrix} e^{-t} + \begin{pmatrix} 0 \\ 4 \\ -4 \end{pmatrix} e^{2t}. \end{aligned}$$

26. Differentiation, elementwise, results in

$$\Psi' = \begin{pmatrix} e^t & -2e^{-2t} & 3e^{3t} \\ -4e^t & 2e^{-2t} & 6e^{3t} \\ -e^t & 2e^{-2t} & 3e^{3t} \end{pmatrix}.$$

On the other hand,

$$\begin{aligned} \begin{pmatrix} 1 & -1 & 4 \\ 3 & 2 & -1 \\ 2 & 1 & -1 \end{pmatrix} \Psi &= \begin{pmatrix} 1 & -1 & 4 \\ 3 & 2 & -1 \\ 2 & 1 & -1 \end{pmatrix} \begin{pmatrix} e^t & e^{-2t} & e^{3t} \\ -4e^t & -e^{-2t} & 2e^{3t} \\ -e^t & -e^{-2t} & e^{3t} \end{pmatrix} \\ &= \begin{pmatrix} e^t & -2e^{-2t} & 3e^{3t} \\ -4e^t & 2e^{-2t} & 6e^{3t} \\ -e^t & 2e^{-2t} & 3e^{3t} \end{pmatrix}. \end{aligned}$$

## Section 7.3

4. The augmented matrix is

$$\left( \begin{array}{ccc|c} 1 & 2 & -1 & 0 \\ 2 & 1 & 1 & 0 \\ 1 & -1 & 2 & 0 \end{array} \right).$$

Adding  $-2$  times the *first row* to the *second row* and subtracting the *first row* from the *third row* results in

$$\left( \begin{array}{ccc|c} 1 & 2 & -1 & 0 \\ 0 & -3 & 3 & 0 \\ 0 & -3 & 3 & 0 \end{array} \right).$$

Adding the *negative* of the *second row* to the *third row* results in

$$\left( \begin{array}{ccc|c} 1 & 2 & -1 & 0 \\ 0 & -3 & 3 & 0 \\ 0 & 0 & 0 & 0 \end{array} \right).$$

We evidently end up with an equivalent system of equations

$$\begin{aligned} x_1 + 2x_2 - x_3 &= 0 \\ -x_2 + x_3 &= 0. \end{aligned}$$

Since there is no unique solution, let  $x_3 = \alpha$ , where  $\alpha$  is arbitrary. It follows that  $x_2 = \alpha$ , and  $x_1 = -\alpha$ . Hence all solutions have the form

$$\mathbf{x} = \alpha \begin{pmatrix} -1 \\ 1 \\ 1 \end{pmatrix}.$$

5. The augmented matrix is

$$\left( \begin{array}{ccc|c} 1 & 0 & -1 & 0 \\ 3 & 1 & 1 & 0 \\ -1 & 1 & 2 & 0 \end{array} \right).$$

Adding  $-3$  times the *first row* to the *second row* and adding the *first row* to the *last row* yields

$$\left( \begin{array}{ccc|c} 1 & 0 & -1 & 0 \\ 0 & 1 & 3 & 0 \\ 0 & 1 & 1 & 0 \end{array} \right).$$

Now add the *negative* of the *second row* to the *third row* to obtain

$$\left( \begin{array}{ccc|c} 1 & 0 & -1 & 0 \\ 0 & 1 & 3 & 0 \\ 0 & 0 & -2 & 0 \end{array} \right).$$

We end up with an equivalent linear system

$$\begin{aligned} x_1 - x_3 &= 0 \\ x_2 + 3x_3 &= 0 \\ x_3 &= 0. \end{aligned}$$

Hence the unique solution of the given system of equations is  $x_1 = x_2 = x_3 = 0$ .

7. Write the given vectors as *columns* of the matrix

$$\mathbf{X} = \begin{pmatrix} 2 & 0 & -1 \\ 1 & 1 & 2 \\ 0 & 0 & 0 \end{pmatrix}.$$

It is evident that  $\det(\mathbf{X}) = 0$ . Hence the vectors are *linearly dependent*. In order to find a linear relationship between them, write  $c_1\mathbf{x}^{(1)} + c_2\mathbf{x}^{(2)} + c_3\mathbf{x}^{(3)} = \mathbf{0}$ . The latter equation is equivalent to

$$\begin{pmatrix} 2 & 0 & -1 \\ 1 & 1 & 2 \\ 0 & 0 & 0 \end{pmatrix} \begin{pmatrix} c_1 \\ c_2 \\ c_3 \end{pmatrix} = \begin{pmatrix} 0 \\ 0 \\ 0 \end{pmatrix}.$$

Performing elementary row operations,

$$\left( \begin{array}{ccc|c} 2 & 0 & -1 & 0 \\ 1 & 1 & 2 & 0 \\ 0 & 0 & 0 & 0 \end{array} \right) \rightarrow \left( \begin{array}{ccc|c} 1 & 0 & -1/2 & 0 \\ 0 & 1 & 5/2 & 0 \\ 0 & 0 & 0 & 0 \end{array} \right).$$

We obtain the system of equations

$$\begin{aligned} c_1 - c_3/2 &= 0 \\ c_2 + 5c_3/2 &= 0. \end{aligned}$$

Setting  $c_3 = 2$ , it follows that  $c_1 = 1$  and  $c_2 = -5$ . Hence

$$\mathbf{x}^{(1)} - 5\mathbf{x}^{(2)} + 2\mathbf{x}^{(3)} = \mathbf{0}.$$

9. The matrix containing the given vectors as *columns* is

$$\mathbf{X} = \begin{pmatrix} 1 & 2 & -1 & 3 \\ 2 & 3 & 0 & -1 \\ -1 & 1 & 2 & 1 \\ 0 & -1 & 2 & 3 \end{pmatrix}.$$



We find that  $\det(\mathbf{X}) = -70$ . Hence the given vectors are *linearly independent*.

10. Write the given vectors as *columns* of the matrix

$$\mathbf{X} = \begin{pmatrix} 1 & 3 & 2 & 4 \\ 2 & 1 & -1 & 3 \\ -2 & 0 & 1 & -2 \end{pmatrix}.$$

The *four* vectors are necessarily *linearly dependent*. Hence there are nonzero scalars such that  $c_1\mathbf{x}^{(1)} + c_2\mathbf{x}^{(2)} + c_3\mathbf{x}^{(3)} + c_4\mathbf{x}^{(4)} = \mathbf{0}$ . The latter equation is equivalent to

$$\begin{pmatrix} 1 & 3 & 2 & 4 \\ 2 & 1 & -1 & 3 \\ -2 & 0 & 1 & -2 \end{pmatrix} \begin{pmatrix} c_1 \\ c_2 \\ c_3 \\ c_4 \end{pmatrix} = \begin{pmatrix} 0 \\ 0 \\ 0 \end{pmatrix}.$$

Performing elementary row operations,

$$\left( \begin{array}{cccc|c} 1 & 3 & 2 & 4 & 0 \\ 2 & 1 & -1 & 3 & 0 \\ -2 & 0 & 1 & -2 & 0 \end{array} \right) \rightarrow \left( \begin{array}{cccc|c} 1 & 0 & 0 & 1 & 0 \\ 0 & 1 & 0 & 1 & 0 \\ 0 & 0 & 1 & 0 & 0 \end{array} \right).$$

We end up with an equivalent linear system

$$\begin{aligned} c_1 + c_4 &= 0 \\ c_2 + c_4 &= 0 \\ c_3 &= 0. \end{aligned}$$

Let  $c_4 = -1$ . Then  $c_1 = 1$  and  $c_2 = 1$ . Therefore we find that

$$\mathbf{x}^{(1)} + \mathbf{x}^{(2)} - \mathbf{x}^{(4)} = \mathbf{0}.$$

11. The matrix containing the given vectors as *columns*,  $\mathbf{X}$ , is of size  $n \times m$ . Since  $n < m$ , we can augment the matrix with  $m - n$  rows of *zeros*. The resulting matrix,  $\tilde{\mathbf{X}}$ , is of size  $m \times m$ . Since  $\tilde{\mathbf{X}}$  is square matrix, with *at least* one row of *zeros*, it follows that  $\det(\tilde{\mathbf{X}}) = 0$ . Hence the column vectors of  $\tilde{\mathbf{X}}$  are linearly dependent. That is, there is a *nonzero* vector,  $\mathbf{c}$ , such that  $\tilde{\mathbf{X}}\mathbf{c} = \mathbf{0}_{m \times 1}$ . If we write only the first  $n$  rows of the latter equation, we have  $\mathbf{X}\mathbf{c} = \mathbf{0}_{n \times 1}$ . Therefore the column vectors of  $\mathbf{X}$  are *linearly dependent*.

12. By inspection, we find that

$$\mathbf{x}^{(1)}(t) - 2\mathbf{x}^{(2)}(t) = \begin{pmatrix} -e^{-t} \\ 0 \end{pmatrix}.$$

Hence  $3\mathbf{x}^{(1)}(t) - 6\mathbf{x}^{(2)}(t) + \mathbf{x}^{(3)}(t) = \mathbf{0}$ , and the vectors are *linearly dependent*.

13. Two vectors are *linearly dependent* if and only if one is a *nonzero* scalar multiple

of the other. However, there is no *nonzero* scalar,  $c$ , such that  $2 \sin t = c \sin t$  and  $\sin t = 2c \sin t$  for all  $t \in (-\infty, \infty)$ . Therefore the vectors are *linearly independent*.

16. The eigenvalues  $\lambda$  and eigenvectors  $\mathbf{x}$  satisfy the equation

$$\begin{pmatrix} 3 - \lambda & -2 \\ 4 & -1 - \lambda \end{pmatrix} \begin{pmatrix} x_1 \\ x_2 \end{pmatrix} = \begin{pmatrix} 0 \\ 0 \end{pmatrix}.$$

For a nonzero solution, we must have  $(3 - \lambda)(-1 - \lambda) + 8 = 0$ , that is,

$$\lambda^2 - 2\lambda + 5 = 0.$$

The eigenvalues are  $\lambda_1 = 1 - 2i$  and  $\lambda_2 = 1 + 2i$ . The components of the eigenvector  $\mathbf{x}^{(1)}$  are solutions of the system

$$\begin{pmatrix} 2 + 2i & -2 \\ 4 & -2 + 2i \end{pmatrix} \begin{pmatrix} x_1 \\ x_2 \end{pmatrix} = \begin{pmatrix} 0 \\ 0 \end{pmatrix}.$$

The two equations reduce to  $(1 + i)x_1 = x_2$ . Hence  $\mathbf{x}^{(1)} = (1, 1 + i)^T$ . Now setting  $\lambda = \lambda_2 = 1 + 2i$ , we have

$$\begin{pmatrix} 2 - 2i & -2 \\ 4 & -2 - 2i \end{pmatrix} \begin{pmatrix} x_1 \\ x_2 \end{pmatrix} = \begin{pmatrix} 0 \\ 0 \end{pmatrix},$$

with solution given by  $\mathbf{x}^{(2)} = (1, 1 - i)^T$ .

17. The eigenvalues  $\lambda$  and eigenvectors  $\mathbf{x}$  satisfy the equation

$$\begin{pmatrix} -2 - \lambda & 1 \\ 1 & -2 - \lambda \end{pmatrix} \begin{pmatrix} x_1 \\ x_2 \end{pmatrix} = \begin{pmatrix} 0 \\ 0 \end{pmatrix}.$$

For a nonzero solution, we must have  $(-2 - \lambda)(-2 - \lambda) - 1 = 0$ , that is,

$$\lambda^2 + 4\lambda + 3 = 0.$$

The eigenvalues are  $\lambda_1 = -3$  and  $\lambda_2 = -1$ . For  $\lambda_1 = -3$ , the system of equations becomes

$$\begin{pmatrix} 1 & 1 \\ 1 & 1 \end{pmatrix} \begin{pmatrix} x_1 \\ x_2 \end{pmatrix} = \begin{pmatrix} 0 \\ 0 \end{pmatrix},$$

which reduces to  $x_1 + x_2 = 0$ . A solution vector is given by  $\mathbf{x}^{(1)} = (1, -1)^T$ . Substituting  $\lambda = \lambda_2 = -1$ , we have

$$\begin{pmatrix} -1 & 1 \\ 1 & -1 \end{pmatrix} \begin{pmatrix} x_1 \\ x_2 \end{pmatrix} = \begin{pmatrix} 0 \\ 0 \end{pmatrix}.$$

The equations reduce to  $x_1 = x_2$ . Hence a solution vector is given by  $\mathbf{x}^{(2)} = (1, 1)^T$ .

19. The eigensystem is obtained from analysis of the equation

$$\begin{pmatrix} 1 - \lambda & \sqrt{3} \\ \sqrt{3} & -1 - \lambda \end{pmatrix} \begin{pmatrix} x_1 \\ x_2 \end{pmatrix} = \begin{pmatrix} 0 \\ 0 \end{pmatrix}.$$

For a nonzero solution, the determinant of the coefficient matrix must be zero. That is,

$$\lambda^2 - 4 = 0.$$

Hence the eigenvalues are  $\lambda_1 = -2$  and  $\lambda_2 = 2$ . Substituting the first eigenvalue,  $\lambda = -2$ , yields

$$\begin{pmatrix} 3 & \sqrt{3} \\ \sqrt{3} & 1 \end{pmatrix} \begin{pmatrix} x_1 \\ x_2 \end{pmatrix} = \begin{pmatrix} 0 \\ 0 \end{pmatrix}.$$

The system is equivalent to the equation  $\sqrt{3}x_1 + x_2 = 0$ . A solution vector is given by  $\mathbf{x}^{(1)} = (1, -\sqrt{3})^T$ . Substitution of  $\lambda = 2$  results in

$$\begin{pmatrix} -1 & \sqrt{3} \\ \sqrt{3} & -3 \end{pmatrix} \begin{pmatrix} x_1 \\ x_2 \end{pmatrix} = \begin{pmatrix} 0 \\ 0 \end{pmatrix},$$

which reduces to  $x_1 = \sqrt{3}x_2$ . A corresponding solution vector is  $\mathbf{x}^{(2)} = (\sqrt{3}, 1)^T$ .

20. The eigenvalues  $\lambda$  and eigenvectors  $\mathbf{x}$  satisfy the equation

$$\begin{pmatrix} -3 - \lambda & 3/4 \\ -5 & 1 - \lambda \end{pmatrix} \begin{pmatrix} x_1 \\ x_2 \end{pmatrix} = \begin{pmatrix} 0 \\ 0 \end{pmatrix}.$$

For a nonzero solution, we must have  $(-3 - \lambda)(1 - \lambda) + 15/4 = 0$ , that is,

$$\lambda^2 + 2\lambda + 3/4 = 0.$$

Hence the eigenvalues are  $\lambda_1 = -3/2$  and  $\lambda_2 = -1/2$ . In order to determine the eigenvector corresponding to  $\lambda_1$ , set  $\lambda = -3/2$ . The system of equations becomes

$$\begin{pmatrix} -3/2 & 3/4 \\ -5 & 5/2 \end{pmatrix} \begin{pmatrix} x_1 \\ x_2 \end{pmatrix} = \begin{pmatrix} 0 \\ 0 \end{pmatrix},$$

which reduces to  $-2x_1 + x_2 = 0$ . A solution vector is given by  $\mathbf{x}^{(1)} = (1, 2)^T$ . Substitution of  $\lambda = \lambda_2 = -1/2$  results in

$$\begin{pmatrix} -5/2 & 3/4 \\ -5 & 3/2 \end{pmatrix} \begin{pmatrix} x_1 \\ x_2 \end{pmatrix} = \begin{pmatrix} 0 \\ 0 \end{pmatrix},$$

which reduces to  $10x_1 = 3x_2$ . A corresponding solution vector is  $\mathbf{x}^{(2)} = (3, 10)^T$ .

22. The eigensystem is obtained from analysis of the equation

$$\begin{pmatrix} 3 - \lambda & 2 & 2 \\ 1 & 4 - \lambda & 1 \\ -2 & -4 & -1 - \lambda \end{pmatrix} \begin{pmatrix} x_1 \\ x_2 \\ x_3 \end{pmatrix} = \begin{pmatrix} 0 \\ 0 \\ 0 \end{pmatrix}.$$

The characteristic equation of the coefficient matrix is  $\lambda^3 - 6\lambda^2 + 11\lambda - 6 = 0$ , with roots  $\lambda_1 = 1$ ,  $\lambda_2 = 2$  and  $\lambda_3 = 3$ . Setting  $\lambda = \lambda_1 = 1$ , we have

$$\begin{pmatrix} 2 & 2 & 2 \\ 1 & 3 & 1 \\ -2 & -4 & -2 \end{pmatrix} \begin{pmatrix} x_1 \\ x_2 \\ x_3 \end{pmatrix} = \begin{pmatrix} 0 \\ 0 \\ 0 \end{pmatrix}.$$

This system reduces to the equations

$$\begin{aligned} x_1 + x_3 &= 0 \\ x_2 &= 0. \end{aligned}$$

A corresponding solution vector is given by  $\mathbf{x}^{(1)} = (1, 0, -1)^T$ . Setting  $\lambda = \lambda_2 = 2$ , the *reduced* system of equations is

$$\begin{aligned} x_1 + 2x_2 &= 0 \\ x_3 &= 0. \end{aligned}$$

A corresponding solution vector is given by  $\mathbf{x}^{(2)} = (-2, 1, 0)^T$ . Finally, setting  $\lambda = \lambda_3 = 3$ , the *reduced* system of equations is

$$\begin{aligned} x_1 &= 0 \\ x_2 + x_3 &= 0. \end{aligned}$$

A corresponding solution vector is given by  $\mathbf{x}^{(3)} = (0, 1, -1)^T$ .

23. For computational purposes, note that if  $\lambda$  is an eigenvalue of  $\mathbf{B}$ , then  $c\lambda$  is an eigenvalue of the matrix  $\mathbf{A} = c\mathbf{B}$ . Eigenvectors are unaffected, since they are only determined up to a scalar multiple. So with

$$\mathbf{B} = \begin{pmatrix} 11 & -2 & 8 \\ -2 & 2 & 10 \\ 8 & 10 & 5 \end{pmatrix},$$

the associated characteristic equation is  $\mu^3 - 18\mu^2 - 81\mu + 1458 = 0$ , with roots  $\mu_1 = -9$ ,  $\mu_2 = 9$  and  $\mu_3 = 18$ . Hence the eigenvalues of the given matrix,  $\mathbf{A}$ , are  $\lambda_1 = -1$ ,  $\lambda_2 = 1$  and  $\lambda_3 = 2$ . Setting  $\lambda = \lambda_1 = -1$ , (which corresponds to using  $\mu_1 = -9$  in the *modified* problem) the *reduced* system of equations is

$$\begin{aligned} 2x_1 + x_3 &= 0 \\ x_2 + x_3 &= 0. \end{aligned}$$

A corresponding solution vector is given by  $\mathbf{x}^{(1)} = (1, 2, -2)^T$ . Setting  $\lambda = \lambda_2 = 1$ , the *reduced* system of equations is

$$\begin{aligned}x_1 + 2x_3 &= 0 \\x_2 - 2x_3 &= 0.\end{aligned}$$

A corresponding solution vector is given by  $\mathbf{x}^{(2)} = (2, -2, -1)^T$ . Finally, setting  $\lambda = \lambda_2 = 1$ , the *reduced* system of equations is

$$\begin{aligned}x_1 - x_3 &= 0 \\2x_2 - x_3 &= 0.\end{aligned}$$

A corresponding solution vector is given by  $\mathbf{x}^{(3)} = (2, 1, 2)^T$ .

25. Suppose that  $\mathbf{Ax} = \mathbf{0}$ , but that  $\mathbf{x} \neq \mathbf{0}$ . Let  $\mathbf{A} = (a_{ij})$ . Using elementary row operations, it is possible to transform the matrix into one that is *not* upper triangular. If it were upper triangular, backsubstitution would imply that  $\mathbf{x} = \mathbf{0}$ . Hence a linear combination of all the rows results in a row containing only *zeros*. That is, there are  $n$  scalars,  $\beta_i$ , one for each row and not all zero, such that for each column  $j$ ,

$$\sum_{i=1}^n \beta_i a_{ij} = 0.$$

Now consider  $\mathbf{A}^* = (b_{ij})$ . By definition,  $b_{ij} = \overline{a_{ji}}$ , or  $a_{ij} = \overline{b_{ji}}$ . It follows that for each  $j$ ,

$$\sum_{i=1}^n \beta_i \overline{b_{ji}} = \sum_{k=1}^n \overline{b_{jk}} \beta_k = \sum_{k=1}^n b_{jk} \overline{\beta_k} = 0.$$

Let  $\mathbf{y} = (\overline{\beta_1}, \overline{\beta_2}, \dots, \overline{\beta_n})^T$ . We therefore have *nonzero* vector,  $\mathbf{y}$ , such that  $\mathbf{A}^*\mathbf{y} = \mathbf{0}$ .

26. By definition,

$$\begin{aligned}(\mathbf{Ax}, \mathbf{y}) &= \sum_{i=0}^n (\mathbf{Ax})_i \overline{y_i} \\&= \sum_{i=0}^n \sum_{j=0}^n a_{ij} x_j \overline{y_i}.\end{aligned}$$

Let  $b_{ij} = \overline{a_{ji}}$ , so that  $a_{ij} = \overline{b_{ji}}$ . Now interchanging the order of summation,

$$\begin{aligned}(\mathbf{Ax}, \mathbf{y}) &= \sum_{j=0}^n x_j \sum_{i=0}^n a_{ij} \overline{y_i} \\&= \sum_{j=0}^n x_j \sum_{i=0}^n \overline{b_{ji}} \overline{y_i}.\end{aligned}$$

Now note that

$$\sum_{i=0}^n \overline{b_{ji}} \overline{y_i} = \overline{\sum_{i=0}^n b_{ji} y_i} = \overline{(\mathbf{A}^* \mathbf{y})_j}.$$

Therefore

$$(\mathbf{A} \mathbf{x}, \mathbf{y}) = \sum_{j=0}^n x_j \overline{(\mathbf{A}^* \mathbf{y})_j} = (\mathbf{x}, \mathbf{A}^* \mathbf{y}).$$

28. By linearity,

$$\begin{aligned} \mathbf{A}(\mathbf{x}^{(0)} + \alpha \boldsymbol{\xi}) &= \mathbf{A} \mathbf{x}^{(0)} + \alpha \mathbf{A} \boldsymbol{\xi} \\ &= \mathbf{b} + \mathbf{0} \\ &= \mathbf{b}. \end{aligned}$$

29. Let  $c_{ij} = \overline{a_{ji}}$ . By the hypothesis, there is a nonzero vector,  $\mathbf{y}$ , such that

$$\sum_{j=1}^n c_{ij} y_j = \sum_{j=1}^n \overline{a_{ji}} y_j = 0, \quad i = 1, 2, \dots, n.$$

Taking the *conjugate* of both sides, and interchanging the indices, we have

$$\sum_{i=1}^n a_{ij} \overline{y_i} = 0.$$

This implies that a linear combination of *each row* of  $\mathbf{A}$  is equal to *zero*. Now consider the augmented matrix  $[\mathbf{A} \mid \mathbf{b}]$ . Replace the *last* row by

$$\sum_{i=1}^n \overline{y_i} [a_{i1}, a_{i2}, \dots, a_{in}, b_i] = \left[ 0, 0, \dots, 0, \sum_{i=1}^n \overline{y_i} b_i \right].$$

We find that if  $(\mathbf{b}, \mathbf{y}) = 0$ , then the last row of the augmented matrix contains only zeros. Hence there are  $n - 1$  remaining equations. We can now set  $x_n = \alpha$ , some parameter, and solve for the other variables in terms of  $\alpha$ . Therefore the system of equations  $\mathbf{A} \mathbf{x} = \mathbf{b}$  has a solution.

30. If  $\lambda = 0$  is an eigenvalue of  $\mathbf{A}$ , then there is a nonzero vector,  $\mathbf{x}$ , such that

$$\mathbf{A} \mathbf{x} = \lambda \mathbf{x} = \mathbf{0}.$$

That is,  $\mathbf{A} \mathbf{x} = \mathbf{0}$  has a nonzero solution. This implies that the mapping defined by  $\mathbf{A}$  is *not 1-to-1*, and hence not invertible. On the other hand, if  $\mathbf{A}$  is singular, then  $\det(\mathbf{A}) = 0$ .

Thus,  $\mathbf{A} \mathbf{x} = \mathbf{0}$  has a nonzero solution. The latter equation can be written as  $\mathbf{A} \mathbf{x} = 0 \mathbf{x}$ .

31. As shown in Prob. 26,  $(\mathbf{A} \mathbf{x}, \mathbf{y}) = (\mathbf{x}, \mathbf{A}^* \mathbf{y})$ . By definition of a *Hermitian* matrix,

$$\mathbf{A} = \mathbf{A}^*.$$

32(a). Based on Prob. 31,  $(\mathbf{Ax}, \mathbf{x}) = (\mathbf{x}, \mathbf{Ax})$ .

(b). Let  $\mathbf{x}$  be an eigenvector corresponding to an eigenvalue  $\lambda$ . It then follows that  $(\mathbf{Ax}, \mathbf{x}) = (\lambda\mathbf{x}, \mathbf{x})$  and  $(\mathbf{x}, \mathbf{Ax}) = (\mathbf{x}, \lambda\mathbf{x})$ . Based on the properties of the inner product,  $(\lambda\mathbf{x}, \mathbf{x}) = \lambda(\mathbf{x}, \mathbf{x})$  and  $(\mathbf{x}, \lambda\mathbf{x}) = \bar{\lambda}(\mathbf{x}, \mathbf{x})$ . Then from Part (a),

$$\lambda(\mathbf{x}, \mathbf{x}) = \bar{\lambda}(\mathbf{x}, \mathbf{x}).$$

(c). From Part (b),

$$(\lambda - \bar{\lambda})(\mathbf{x}, \mathbf{x}) = 0.$$

Based on the definition of an eigenvector,  $(\mathbf{x}, \mathbf{x}) = \|\mathbf{x}\|^2 > 0$ . Hence we must have  $\lambda - \bar{\lambda} = 0$ , which implies that  $\lambda$  is *real*.

33. From Prob. 31,

$$(\mathbf{Ax}^{(1)}, \mathbf{x}^{(2)}) = (\mathbf{x}^{(1)}, \mathbf{Ax}^{(2)}).$$

Hence

$$\lambda_1(\mathbf{x}^{(1)}, \mathbf{x}^{(2)}) = \bar{\lambda}_2(\mathbf{x}^{(1)}, \mathbf{x}^{(2)}) = \lambda_2(\mathbf{x}^{(1)}, \mathbf{x}^{(2)}),$$

since the eigenvalues are real. Therefore

$$(\lambda_1 - \lambda_2)(\mathbf{x}^{(1)}, \mathbf{x}^{(2)}) = 0.$$

Given that  $\lambda_1 \neq \lambda_2$ , we must have  $(\mathbf{x}^{(1)}, \mathbf{x}^{(2)}) = 0$ .

## Section 7.4

3. Eq. (14) states that the Wronskian satisfies the first order linear ODE

$$\frac{dW}{dt} = (p_{11} + p_{22} + \cdots + p_{nn})W.$$

The general solution is

$$W(t) = C \exp \left[ \int (p_{11} + p_{22} + \cdots + p_{nn}) dt \right],$$

in which  $C$  is an arbitrary constant. Let  $\mathbf{X}_1$  and  $\mathbf{X}_2$  be matrices representing two sets of fundamental solutions. It follows that

$$\begin{aligned} \det(\mathbf{X}_1) = W_1(t) &= C_1 \exp \left[ \int (p_{11} + p_{22} + \cdots + p_{nn}) dt \right] \\ \det(\mathbf{X}_2) = W_2(t) &= C_2 \exp \left[ \int (p_{11} + p_{22} + \cdots + p_{nn}) dt \right]. \end{aligned}$$

Hence  $\det(\mathbf{X}_1)/\det(\mathbf{X}_2) = C_1/C_2$ . Note that  $C_2 \neq 0$ .

4. First note that  $p_{11} + p_{22} = -p(t)$ . As shown in Prob. (3),

$$W[\mathbf{x}^{(1)}, \mathbf{x}^{(2)}] = c e^{-\int p(t) dt}.$$

For second order linear ODE, the Wronskian (as defined in Chap. 3) satisfies the first order differential equation  $W' + p(t)W = 0$ . It follows that

$$W[y^{(1)}, y^{(2)}] = c_1 e^{-\int p(t) dt}.$$

Alternatively, based on the hypothesis,

$$\begin{aligned} y^{(1)} &= \alpha_{11} x_{11} + \alpha_{12} x_{12} \\ y^{(2)} &= \alpha_{21} x_{11} + \alpha_{22} x_{12}. \end{aligned}$$

Direct calculation shows that

$$\begin{aligned} W[y^{(1)}, y^{(2)}] &= \begin{vmatrix} \alpha_{11} x_{11} + \alpha_{12} x_{12} & \alpha_{21} x_{11} + \alpha_{22} x_{12} \\ \alpha_{11} x'_{11} + \alpha_{12} x'_{12} & \alpha_{21} x'_{11} + \alpha_{22} x'_{12} \end{vmatrix} \\ &= (\alpha_{11}\alpha_{22} - \alpha_{12}\alpha_{21})x_{11}x'_{12} - (\alpha_{11}\alpha_{22} - \alpha_{12}\alpha_{21})x_{12}x'_{11} \\ &= (\alpha_{11}\alpha_{22} - \alpha_{12}\alpha_{21})x_{11}x_{22} - (\alpha_{11}\alpha_{22} - \alpha_{12}\alpha_{21})x_{12}x_{21}. \end{aligned}$$

Here we used the fact that  $x'_1 = x_2$ . Hence

$$W[y^{(1)}, y^{(2)}] = (\alpha_{11}\alpha_{22} - \alpha_{12}\alpha_{21})W[\mathbf{x}^{(1)}, \mathbf{x}^{(2)}].$$

5. The *particular solution* satisfies the ODE  $[\mathbf{x}^{(p)}]' = \mathbf{P}(t)\mathbf{x}^{(p)} + \mathbf{g}(t)$ . Now let



$\mathbf{x} = \phi(t)$  be any solution of the homogeneous equation. That is,  $\mathbf{x}' = \mathbf{P}(t)\mathbf{x}$ . We know that  $\mathbf{x} = \mathbf{x}^c$ , in which  $\mathbf{x}^c$  is a linear combination of some fundamental solution. By linearity of the differential equation, it follows that  $\mathbf{x} = \mathbf{x}^{(p)} + \mathbf{x}^c$  is a solution of the ODE. Based on the *uniqueness theorem*, all solutions must have this form.

7(a). By definition,

$$W[\mathbf{x}^{(1)}, \mathbf{x}^{(2)}] = \begin{vmatrix} t^2 & e^t \\ 2t & e^t \end{vmatrix} = (t^2 - 2t)e^t.$$

(b). The Wronskian vanishes at  $t_0 = 0$  and  $t_0 = 2$ . Hence the vectors are linearly independent on  $\mathcal{D} = (-\infty, 0) \cup (0, 2) \cup (2, \infty)$ .

(c). It follows from Theorem 7.4.3 that one or more of the coefficients of the ODE must be discontinuous at  $t_0 = 0$  and  $t_0 = 2$ . If not, the Wronskian would not vanish.

(d). Let

$$\mathbf{x} = c_1 \begin{pmatrix} t^2 \\ 2t \end{pmatrix} + c_2 \begin{pmatrix} e^t \\ e^t \end{pmatrix}.$$

Then

$$\mathbf{x}' = c_1 \begin{pmatrix} 2t \\ 2 \end{pmatrix} + c_2 \begin{pmatrix} e^t \\ e^t \end{pmatrix}.$$

On the other hand,

$$\begin{aligned} \begin{pmatrix} p_{11} & p_{12} \\ p_{21} & p_{22} \end{pmatrix} \mathbf{x} &= c_1 \begin{pmatrix} p_{11} & p_{12} \\ p_{21} & p_{22} \end{pmatrix} \begin{pmatrix} t^2 \\ 2t \end{pmatrix} + c_2 \begin{pmatrix} p_{11} & p_{12} \\ p_{21} & p_{22} \end{pmatrix} \begin{pmatrix} e^t \\ e^t \end{pmatrix} \\ &= \begin{pmatrix} c_1[p_{11}t^2 + 2p_{12}t] + c_2[p_{11} + p_{12}]e^t \\ c_1[p_{21}t^2 + 2p_{22}t] + c_2[p_{21} + p_{22}]e^t \end{pmatrix}. \end{aligned}$$

Comparing coefficients, we find that

$$\begin{aligned} p_{11}t^2 + 2p_{12}t &= 2t \\ p_{11} + p_{12} &= 1 \\ p_{21}t^2 + 2p_{22}t &= 2 \\ p_{21} + p_{22} &= 1. \end{aligned}$$

Solution of this system of equations results in

$$p_{11}(t) = 0, p_{12}(t) = 1, p_{21}(t) = \frac{2 - 2t}{t^2 - 2t}, p_{22}(t) = \frac{t^2 - 2}{t^2 - 2t}.$$

Hence the vectors are solutions of the ODE

$$\mathbf{x}' = \frac{1}{t^2 - 2t} \begin{pmatrix} 0 & t^2 - 2t \\ 2 - 2t & t^2 - 2 \end{pmatrix} \mathbf{x}.$$

8. Suppose that the solutions  $\mathbf{x}^{(1)}, \mathbf{x}^{(2)}, \dots, \mathbf{x}^{(m)}$  are linearly *dependent* at  $t = t_0$ . Then there are constants  $c_1, c_2, \dots, c_m$  (not all zero) such that

$$c_1 \mathbf{x}^{(1)}(t_0) + c_2 \mathbf{x}^{(2)}(t_0) + \dots + c_m \mathbf{x}^{(m)}(t_0) = \mathbf{0}.$$

Now let  $\mathbf{z}(t) = c_1 \mathbf{x}^{(1)}(t) + c_2 \mathbf{x}^{(2)}(t) + \dots + c_m \mathbf{x}^{(m)}(t)$ . Then clearly,  $\mathbf{z}(t)$  is a solution of  $\mathbf{x}' = \mathbf{P}(t)\mathbf{x}$ , with  $\mathbf{z}(t_0) = \mathbf{0}$ . Furthermore,  $\mathbf{y}(t) \equiv \mathbf{0}$  is also a solution, with  $\mathbf{y}(t_0) = \mathbf{0}$ . By the *uniqueness theorem*,  $\mathbf{z}(t) = \mathbf{y}(t) = \mathbf{0}$ . Hence

$$c_1 \mathbf{x}^{(1)}(t) + c_2 \mathbf{x}^{(2)}(t) + \dots + c_m \mathbf{x}^{(m)}(t) = \mathbf{0}$$

on the entire interval  $\alpha < t < \beta$ . Going in the other direction is trivial.

9(a). Let  $\mathbf{y}(t)$  be *any* solution of  $\mathbf{x}' = \mathbf{P}(t)\mathbf{x}$ . It follows that

$$\mathbf{z}(t) + \mathbf{y}(t) = c_1 \mathbf{x}^{(1)}(t) + c_2 \mathbf{x}^{(2)}(t) + \dots + c_n \mathbf{x}^{(n)}(t) + \mathbf{y}(t)$$

is also a solution. Now let  $t_0 \in (\alpha, \beta)$ . Then the collection of vectors

$$\mathbf{x}^{(1)}(t_0), \mathbf{x}^{(2)}(t_0), \dots, \mathbf{x}^{(n)}(t_0), \mathbf{y}(t_0)$$

constitutes  $n + 1$  vectors, each with  $n$  components. Based on the assertion in Prob. 11, Section 7.3, these vectors are necessarily linearly *dependent*. That is, there are  $n + 1$  constants  $b_1, b_2, \dots, b_n, b_{n+1}$  (not all zero) such that

$$b_1 \mathbf{x}^{(1)}(t_0) + b_2 \mathbf{x}^{(2)}(t_0) + \dots + b_n \mathbf{x}^{(n)}(t_0) + b_{n+1} \mathbf{y}(t_0) = \mathbf{0}.$$

From Prob. 8, we have

$$b_1 \mathbf{x}^{(1)}(t) + b_2 \mathbf{x}^{(2)}(t) + \dots + b_n \mathbf{x}^{(n)}(t) + b_{n+1} \mathbf{y}(t) = \mathbf{0}$$

for all  $t \in (\alpha, \beta)$ . Now  $b_{n+1} \neq 0$ , otherwise that would contradict the fact that the first  $n$  vectors are linearly independent. Hence

$$\mathbf{y}(t) = -\frac{1}{b_{n+1}} (b_1 \mathbf{x}^{(1)}(t) + b_2 \mathbf{x}^{(2)}(t) + \dots + b_n \mathbf{x}^{(n)}(t)),$$

and the assertion is true.

(b). Consider  $\mathbf{z}(t) = c_1 \mathbf{x}^{(1)}(t) + c_2 \mathbf{x}^{(2)}(t) + \dots + c_n \mathbf{x}^{(n)}(t)$ , and suppose that we also have

$$\mathbf{z}(t) = k_1 \mathbf{x}^{(1)}(t) + k_2 \mathbf{x}^{(2)}(t) + \dots + k_n \mathbf{x}^{(n)}(t).$$

Based on the assumption,

$$(k_1 - c_1)\mathbf{x}^{(1)}(t) + (k_2 - c_2)\mathbf{x}^{(2)}(t) + \cdots + (k_n - c_n)\mathbf{x}^{(n)}(t) = \mathbf{0}.$$

The collection of vectors

$$\mathbf{x}^{(1)}(t), \mathbf{x}^{(2)}(t), \dots, \mathbf{x}^{(n)}(t)$$

is linearly *independent* on  $\alpha < t < \beta$ . It follows that  $k_i - c_i = 0$ , for  $i = 1, 2, \dots, n$ .

## Section 7.5

2. Setting  $\mathbf{x} = \boldsymbol{\xi} e^{rt}$ , and substituting into the ODE, we obtain the algebraic equations

$$\begin{pmatrix} 1-r & -2 \\ 3 & -4-r \end{pmatrix} \begin{pmatrix} \xi_1 \\ \xi_2 \end{pmatrix} = \begin{pmatrix} 0 \\ 0 \end{pmatrix}.$$

For a nonzero solution, we must have  $\det(\mathbf{A} - r\mathbf{I}) = r^2 + 3r + 2 = 0$ . The roots of the characteristic equation are  $r_1 = -1$  and  $r_2 = -2$ . For  $r = -1$ , the two equations reduce to  $\xi_1 = \xi_2$ . The corresponding eigenvector is  $\boldsymbol{\xi}^{(1)} = (1, 1)^T$ . Substitution of  $r = -2$  results in the single equation  $3\xi_1 = 2\xi_2$ . A corresponding eigenvector is  $\boldsymbol{\xi}^{(2)} = (2, 3)^T$ . Since the eigenvalues are *distinct*, the general solution is

$$\mathbf{x} = c_1 \begin{pmatrix} 1 \\ 1 \end{pmatrix} e^{-t} + c_2 \begin{pmatrix} 2 \\ 3 \end{pmatrix} e^{-2t}.$$

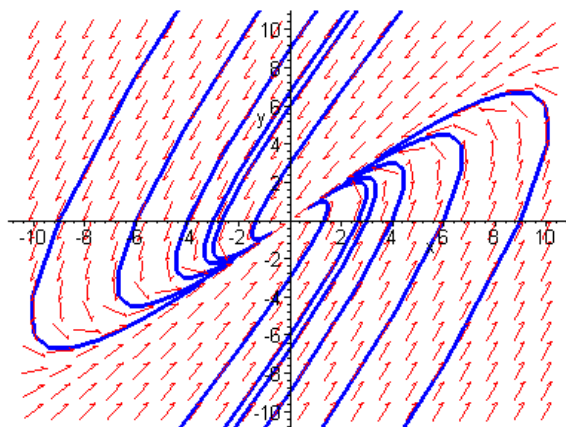

3. Setting  $\mathbf{x} = \boldsymbol{\xi} e^{rt}$  results in the algebraic equations

$$\begin{pmatrix} 2-r & -1 \\ 3 & -2-r \end{pmatrix} \begin{pmatrix} \xi_1 \\ \xi_2 \end{pmatrix} = \begin{pmatrix} 0 \\ 0 \end{pmatrix}.$$

For a nonzero solution, we must have  $\det(\mathbf{A} - r\mathbf{I}) = r^2 - 1 = 0$ . The roots of the characteristic equation are  $r_1 = 1$  and  $r_2 = -1$ . For  $r = 1$ , the system of equations reduces to  $\xi_1 = \xi_2$ . The corresponding eigenvector is  $\boldsymbol{\xi}^{(1)} = (1, 1)^T$ . Substitution of  $r = -1$  results in the single equation  $3\xi_1 = \xi_2$ . A corresponding eigenvector is  $\boldsymbol{\xi}^{(2)} = (1, 3)^T$ . Since the eigenvalues are *distinct*, the general solution is

$$\mathbf{x} = c_1 \begin{pmatrix} 1 \\ 1 \end{pmatrix} e^t + c_2 \begin{pmatrix} 1 \\ 3 \end{pmatrix} e^{-t}.$$

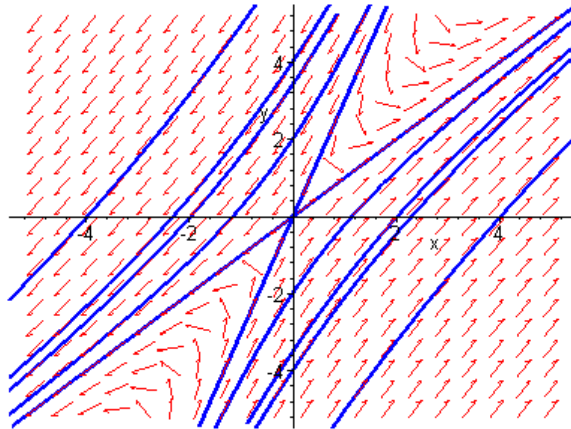

The system has an *unstable* eigendirection along  $\boldsymbol{\xi}^{(1)} = (1, 1)^T$ . Unless  $c_1 = 0$ , all solutions will diverge.

4. Solution of the ODE requires analysis of the algebraic equations

$$\begin{pmatrix} 1 - r & 1 \\ 4 & -2 - r \end{pmatrix} \begin{pmatrix} \xi_1 \\ \xi_2 \end{pmatrix} = \begin{pmatrix} 0 \\ 0 \end{pmatrix}.$$

For a nonzero solution, we must have  $\det(\mathbf{A} - r\mathbf{I}) = r^2 + r - 6 = 0$ . The roots of the characteristic equation are  $r_1 = 2$  and  $r_2 = -3$ . For  $r = 2$ , the system of equations reduces to  $\xi_1 = \xi_2$ . The corresponding eigenvector is  $\boldsymbol{\xi}^{(1)} = (1, 1)^T$ . Substitution of  $r = -3$  results in the single equation  $4\xi_1 + \xi_2 = 0$ . A corresponding eigenvector is  $\boldsymbol{\xi}^{(2)} = (1, -4)^T$ . Since the eigenvalues are *distinct*, the general solution is

$$\mathbf{x} = c_1 \begin{pmatrix} 1 \\ 1 \end{pmatrix} e^{2t} + c_2 \begin{pmatrix} 1 \\ -4 \end{pmatrix} e^{-3t}.$$

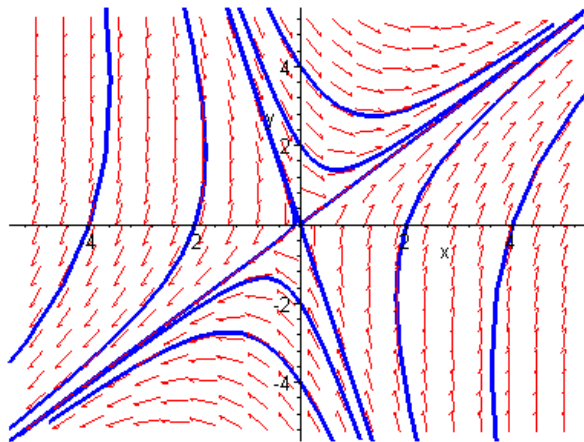

The system has an *unstable* eigendirection along  $\boldsymbol{\xi}^{(1)} = (1, 1)^T$ . Unless  $c_1 = 0$ , all solutions will diverge.

8. Setting  $\mathbf{x} = \boldsymbol{\xi} e^{rt}$  results in the algebraic equations

$$\begin{pmatrix} 3-r & 6 \\ -1 & -2-r \end{pmatrix} \begin{pmatrix} \xi_1 \\ \xi_2 \end{pmatrix} = \begin{pmatrix} 0 \\ 0 \end{pmatrix}.$$

For a nonzero solution, we must have  $\det(\mathbf{A} - r\mathbf{I}) = r^2 - r = 0$ . The roots of the characteristic equation are  $r_1 = 1$  and  $r_2 = 0$ . With  $r = 1$ , the system of equations reduces to  $\xi_1 + 3\xi_2 = 0$ . The corresponding eigenvector is  $\boldsymbol{\xi}^{(1)} = (3, -1)^T$ . For the case  $r = 0$ , the system is equivalent to the equation  $\xi_1 + 2\xi_2 = 0$ . An eigenvector is  $\boldsymbol{\xi}^{(2)} = (2, -1)^T$ . Since the eigenvalues are *distinct*, the general solution is

$$\mathbf{x} = c_1 \begin{pmatrix} 3 \\ -1 \end{pmatrix} e^t + c_2 \begin{pmatrix} 2 \\ -1 \end{pmatrix}.$$

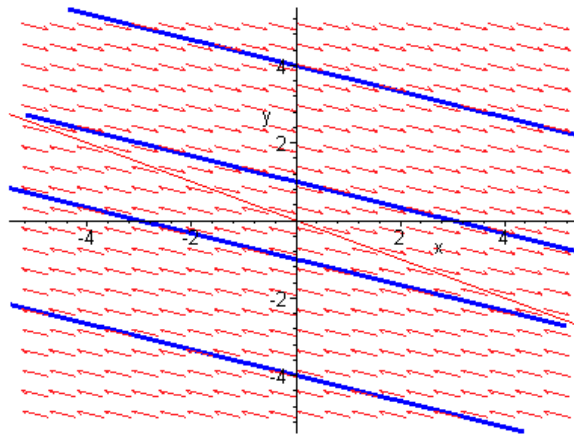

The *entire line* along the eigendirection  $\boldsymbol{\xi}^{(2)} = (2, -1)^T$  consists of equilibrium points. All other solutions diverge. The direction field changes across the line  $x_1 + 2x_2 = 0$ . Eliminating the exponential terms in the solution, the trajectories are given by

$$x_1 + 3x_2 = -c_2.$$

10. The characteristic equation is given by

$$\begin{vmatrix} 2-r & 2+i \\ -1 & -1-i-r \end{vmatrix} = r^2 - (1-i)r - i = 0.$$

The equation has *complex* roots  $r_1 = 1$  and  $r_2 = -i$ . For  $r = 1$ , the components of the solution vector must satisfy  $\xi_1 + (2+i)\xi_2 = 0$ . Thus the corresponding eigenvector is  $\boldsymbol{\xi}^{(1)} = (2+i, -1)^T$ . Substitution of  $r = -i$  results in the single equation  $\xi_1 + \xi_2 = 0$ . A corresponding eigenvector is  $\boldsymbol{\xi}^{(2)} = (1, -1)^T$ . Since the eigenvalues are *distinct*, the general solution is

$$\mathbf{x} = c_1 \begin{pmatrix} 2+i \\ -1 \end{pmatrix} e^t + c_2 \begin{pmatrix} 1 \\ -1 \end{pmatrix} e^{-it}.$$

11. Setting  $\mathbf{x} = \boldsymbol{\xi} e^{rt}$  results in the algebraic equations

$$\begin{pmatrix} 1-r & 1 & 2 \\ 1 & 2-r & 1 \\ 2 & 1 & 1-r \end{pmatrix} \begin{pmatrix} \xi_1 \\ \xi_2 \\ \xi_3 \end{pmatrix} = \begin{pmatrix} 0 \\ 0 \\ 0 \end{pmatrix}.$$

For a nonzero solution, we must have  $\det(\mathbf{A} - r\mathbf{I}) = r^3 - 4r^2 - r + 4 = 0$ . The roots of the characteristic equation are  $r_1 = 4$ ,  $r_2 = 1$  and  $r_3 = -1$ . Setting  $r = 4$ , we have

$$\begin{pmatrix} -3 & 1 & 2 \\ 1 & -2 & 1 \\ 2 & 1 & -3 \end{pmatrix} \begin{pmatrix} \xi_1 \\ \xi_2 \\ \xi_3 \end{pmatrix} = \begin{pmatrix} 0 \\ 0 \\ 0 \end{pmatrix}.$$

This system reduces to the equations

$$\begin{aligned} \xi_1 - \xi_3 &= 0 \\ \xi_2 - \xi_3 &= 0. \end{aligned}$$

A corresponding solution vector is given by  $\boldsymbol{\xi}^{(1)} = (1, 1, 1)^T$ . Setting  $\lambda = 1$ , the *reduced* system of equations is

$$\begin{aligned} \xi_1 - \xi_3 &= 0 \\ \xi_2 + 2\xi_3 &= 0. \end{aligned}$$

A corresponding solution vector is given by  $\boldsymbol{\xi}^{(2)} = (1, -2, 1)^T$ . Finally, setting  $\lambda = -1$ , the *reduced* system of equations is

$$\begin{aligned} \xi_1 + \xi_3 &= 0 \\ \xi_2 &= 0. \end{aligned}$$

A corresponding solution vector is given by  $\boldsymbol{\xi}^{(3)} = (1, 0, -1)^T$ . Since the eigenvalues are distinct, the general solution is

$$\mathbf{x} = c_1 \begin{pmatrix} 1 \\ 1 \\ 1 \end{pmatrix} e^{4t} + c_2 \begin{pmatrix} 1 \\ -2 \\ 1 \end{pmatrix} e^t + c_3 \begin{pmatrix} 1 \\ 0 \\ -1 \end{pmatrix} e^{-t}.$$

12. The eigensystem is obtained from analysis of the equation

$$\begin{pmatrix} 3-r & 2 & 4 \\ 2 & -r & 2 \\ 4 & 2 & 3-r \end{pmatrix} \begin{pmatrix} \xi_1 \\ \xi_2 \\ \xi_3 \end{pmatrix} = \begin{pmatrix} 0 \\ 0 \\ 0 \end{pmatrix}.$$

The characteristic equation of the coefficient matrix is  $r^3 - 6r^2 - 15r - 8 = 0$ , with roots  $r_1 = 8$ ,  $r_2 = -1$  and  $r_3 = -1$ . Setting  $r = r_1 = 8$ , we have

$$\begin{pmatrix} -5 & 2 & 4 \\ 2 & -8 & 2 \\ 4 & 2 & -5 \end{pmatrix} \begin{pmatrix} \xi_1 \\ \xi_2 \\ \xi_3 \end{pmatrix} = \begin{pmatrix} 0 \\ 0 \\ 0 \end{pmatrix}.$$

This system is reduced to the equations

$$\begin{aligned} \xi_1 - \xi_3 &= 0 \\ 2\xi_2 - \xi_3 &= 0. \end{aligned}$$

A corresponding solution vector is given by  $\boldsymbol{\xi}^{(1)} = (2, 1, 2)^T$ . Setting  $r = -1$ , the system of equations is reduced to the *single* equation

$$2\xi_1 + \xi_2 + 2\xi_3 = 0.$$

Two independent solutions are obtained as

$$\boldsymbol{\xi}^{(2)} = (1, -2, 0)^T \text{ and } \boldsymbol{\xi}^{(3)} = (0, -2, 1)^T.$$

Hence the general solution is

$$\mathbf{x} = c_1 \begin{pmatrix} 2 \\ 1 \\ 2 \end{pmatrix} e^{8t} + c_2 \begin{pmatrix} 1 \\ -2 \\ 0 \end{pmatrix} e^{-t} + c_3 \begin{pmatrix} 0 \\ -2 \\ 1 \end{pmatrix} e^{-t}.$$

13. Setting  $\mathbf{x} = \boldsymbol{\xi} e^{rt}$  results in the algebraic equations

$$\begin{pmatrix} 1-r & 1 & 1 \\ 2 & 1-r & -1 \\ -8 & -5 & -3-r \end{pmatrix} \begin{pmatrix} \xi_1 \\ \xi_2 \\ \xi_3 \end{pmatrix} = \begin{pmatrix} 0 \\ 0 \\ 0 \end{pmatrix}.$$

For a nonzero solution, we must have  $\det(\mathbf{A} - r\mathbf{I}) = r^3 + r^2 - 4r - 4 = 0$ . The roots of the characteristic equation are  $r_1 = 2$ ,  $r_2 = -2$  and  $r_3 = -1$ . Setting  $r = 2$ , we have

$$\begin{pmatrix} -1 & 1 & 1 \\ 2 & -1 & -1 \\ -8 & -5 & -5 \end{pmatrix} \begin{pmatrix} \xi_1 \\ \xi_2 \\ \xi_3 \end{pmatrix} = \begin{pmatrix} 0 \\ 0 \\ 0 \end{pmatrix}.$$

This system is reduced to the equations

$$\begin{aligned} \xi_1 &= 0 \\ \xi_2 + \xi_3 &= 0. \end{aligned}$$

A corresponding solution vector is given by  $\boldsymbol{\xi}^{(1)} = (0, 1, -1)^T$ . Setting  $\lambda = -1$ , the *reduced* system of equations is

$$\begin{aligned} 2\xi_1 + 3\xi_3 &= 0 \\ \xi_2 - 2\xi_3 &= 0. \end{aligned}$$



A corresponding solution vector is given by  $\boldsymbol{\xi}^{(2)} = (3, -4, -2)^T$ . Finally, setting  $\lambda = -2$ , the *reduced* system of equations is

$$\begin{aligned}7\xi_1 + 4\xi_3 &= 0 \\7\xi_2 - 5\xi_3 &= 0.\end{aligned}$$

A corresponding solution vector is given by  $\boldsymbol{\xi}^{(3)} = (4, -5, -7)^T$ . Since the eigenvalues are distinct, the general solution is

$$\mathbf{x} = c_1 \begin{pmatrix} 0 \\ 1 \\ -1 \end{pmatrix} e^{2t} + c_2 \begin{pmatrix} 3 \\ -4 \\ -2 \end{pmatrix} e^{-t} + c_3 \begin{pmatrix} 4 \\ -5 \\ -7 \end{pmatrix} e^{-2t}.$$

15. Setting  $\mathbf{x} = \boldsymbol{\xi} e^{rt}$  results in the algebraic equations

$$\begin{pmatrix} 5-r & -1 \\ 3 & 1-r \end{pmatrix} \begin{pmatrix} \xi_1 \\ \xi_2 \end{pmatrix} = \begin{pmatrix} 0 \\ 0 \end{pmatrix}.$$

For a nonzero solution, we must have  $\det(\mathbf{A} - r\mathbf{I}) = r^2 - 6r + 8 = 0$ . The roots of the characteristic equation are  $r_1 = 4$  and  $r_2 = 2$ . With  $r = 4$ , the system of equations reduces to  $\xi_1 - \xi_2 = 0$ . The corresponding eigenvector is  $\boldsymbol{\xi}^{(1)} = (1, 1)^T$ . For the case  $r = 2$ , the system is equivalent to the equation  $3\xi_1 - \xi_2 = 0$ . An eigenvector is  $\boldsymbol{\xi}^{(2)} = (1, 3)^T$ . Since the eigenvalues are *distinct*, the general solution is

$$\mathbf{x} = c_1 \begin{pmatrix} 1 \\ 1 \end{pmatrix} e^{4t} + c_2 \begin{pmatrix} 1 \\ 3 \end{pmatrix} e^{2t}.$$

Invoking the initial conditions, we obtain the system of equations

$$\begin{aligned}c_1 + c_2 &= 2 \\c_1 + 3c_2 &= -1.\end{aligned}$$

Hence  $c_1 = 7/2$  and  $c_2 = -3/2$ , and the solution of the IVP is

$$\mathbf{x} = \frac{7}{2} \begin{pmatrix} 1 \\ 1 \end{pmatrix} e^{4t} - \frac{3}{2} \begin{pmatrix} 1 \\ 3 \end{pmatrix} e^{2t}.$$

17. Setting  $\mathbf{x} = \boldsymbol{\xi} e^{rt}$  results in the algebraic equations

$$\begin{pmatrix} 1-r & 1 & 2 \\ 0 & 2-r & 2 \\ -1 & 1 & 3-r \end{pmatrix} \begin{pmatrix} \xi_1 \\ \xi_2 \\ \xi_3 \end{pmatrix} = \begin{pmatrix} 0 \\ 0 \\ 0 \end{pmatrix}.$$

For a nonzero solution, we must have  $\det(\mathbf{A} - r\mathbf{I}) = r^3 - 6r^2 + 11r - 6 = 0$ . The roots of the characteristic equation are  $r_1 = 1$ ,  $r_2 = 2$  and  $r_3 = 3$ . Setting  $r = 1$ , we have

$$\begin{pmatrix} 0 & 1 & 2 \\ 0 & 1 & 2 \\ -1 & 1 & 2 \end{pmatrix} \begin{pmatrix} \xi_1 \\ \xi_2 \\ \xi_3 \end{pmatrix} = \begin{pmatrix} 0 \\ 0 \\ 0 \end{pmatrix}.$$

This system reduces to the equations

$$\begin{aligned} \xi_1 &= 0 \\ \xi_2 + 2\xi_3 &= 0. \end{aligned}$$

A corresponding solution vector is given by  $\boldsymbol{\xi}^{(1)} = (0, -2, 1)^T$ . Setting  $\lambda = 2$ , the *reduced* system of equations is

$$\begin{aligned} \xi_1 - \xi_2 &= 0 \\ \xi_3 &= 0. \end{aligned}$$

A corresponding solution vector is given by  $\boldsymbol{\xi}^{(2)} = (1, 1, 0)^T$ . Finally, upon setting  $\lambda = 3$ , the *reduced* system of equations is

$$\begin{aligned} \xi_1 - 2\xi_3 &= 0 \\ \xi_2 - 2\xi_3 &= 0. \end{aligned}$$

A corresponding solution vector is given by  $\boldsymbol{\xi}^{(3)} = (2, 2, 1)^T$ . Since the eigenvalues are distinct, the general solution is

$$\mathbf{x} = c_1 \begin{pmatrix} 0 \\ -2 \\ 1 \end{pmatrix} e^t + c_2 \begin{pmatrix} 1 \\ 1 \\ 0 \end{pmatrix} e^{2t} + c_3 \begin{pmatrix} 2 \\ 2 \\ 1 \end{pmatrix} e^{3t}.$$

Invoking the initial conditions, the coefficients must satisfy the equations

$$\begin{aligned} c_2 + 2c_3 &= 2 \\ -2c_1 + c_2 + 2c_3 &= 0 \\ c_1 + c_3 &= 1. \end{aligned}$$

It follows that  $c_1 = 1$ ,  $c_2 = 2$  and  $c_3 = 0$ . Hence the solution of the IVP is

$$\mathbf{x} = \begin{pmatrix} 0 \\ -2 \\ 1 \end{pmatrix} e^t + 2 \begin{pmatrix} 1 \\ 1 \\ 0 \end{pmatrix} e^{2t}.$$

18. The eigensystem is obtained from analysis of the equation

$$\begin{pmatrix} -r & 0 & -1 \\ 2 & -r & 0 \\ -1 & 2 & 4-r \end{pmatrix} \begin{pmatrix} \xi_1 \\ \xi_2 \\ \xi_3 \end{pmatrix} = \begin{pmatrix} 0 \\ 0 \\ 0 \end{pmatrix}.$$

The characteristic equation of the coefficient matrix is  $r^3 - 4r^2 - r + 4 = 0$ , with roots  $r_1 = -1$ ,  $r_2 = 1$  and  $r_3 = 4$ . Setting  $r = r_1 = -1$ , we have

$$\begin{pmatrix} -1 & 0 & -1 \\ 2 & -1 & 0 \\ -1 & 2 & 3 \end{pmatrix} \begin{pmatrix} \xi_1 \\ \xi_2 \\ \xi_3 \end{pmatrix} = \begin{pmatrix} 0 \\ 0 \\ 0 \end{pmatrix}.$$

This system is reduced to the equations

$$\begin{aligned} \xi_1 - \xi_3 &= 0 \\ \xi_2 + 2\xi_3 &= 0. \end{aligned}$$

A corresponding solution vector is given by  $\boldsymbol{\xi}^{(1)} = (1, -2, 1)^T$ . Setting  $r = 1$ , the system reduces to the equations

$$\begin{aligned} \xi_1 + \xi_3 &= 0 \\ \xi_2 + 2\xi_3 &= 0. \end{aligned}$$

The corresponding eigenvector is  $\boldsymbol{\xi}^{(2)} = (1, 2, -1)^T$ . Finally, upon setting  $r = 4$ , the system is equivalent to the equations

$$\begin{aligned} 4\xi_1 + \xi_3 &= 0 \\ 8\xi_2 + \xi_3 &= 0. \end{aligned}$$

The corresponding eigenvector is  $\boldsymbol{\xi}^{(3)} = (2, 1, -8)^T$ . Hence the general solution is

$$\mathbf{x} = c_1 \begin{pmatrix} 1 \\ -2 \\ 1 \end{pmatrix} e^{-t} + c_2 \begin{pmatrix} 1 \\ 2 \\ -1 \end{pmatrix} e^t + c_3 \begin{pmatrix} 2 \\ 1 \\ -8 \end{pmatrix} e^{4t}.$$

Invoking the initial conditions,

$$\begin{aligned} c_1 + c_2 + 2c_3 &= 7 \\ -2c_1 + 2c_2 + c_3 &= 5 \\ c_1 - c_2 - 8c_3 &= 5. \end{aligned}$$

It follows that  $c_1 = 3$ ,  $c_2 = 6$  and  $c_3 = -1$ . Hence the solution of the IVP is

$$\mathbf{x} = 3 \begin{pmatrix} 1 \\ -2 \\ 1 \end{pmatrix} e^{-t} + 6 \begin{pmatrix} 1 \\ 2 \\ -1 \end{pmatrix} e^t - \begin{pmatrix} 2 \\ 1 \\ -8 \end{pmatrix} e^{4t}.$$

19. Set  $\mathbf{x} = \boldsymbol{\xi} t^r$ . Substitution into the system of differential equations results in

$$t \cdot r t^{r-1} \boldsymbol{\xi} = \mathbf{A} \boldsymbol{\xi} t^r,$$

which upon simplification yields is,  $\mathbf{A} \boldsymbol{\xi} - r \boldsymbol{\xi} = \mathbf{0}$ . Hence the vector  $\boldsymbol{\xi}$  and constant  $r$  must satisfy  $(\mathbf{A} - r \mathbf{I}) \boldsymbol{\xi} = \mathbf{0}$ .

21. Setting  $\mathbf{x} = \boldsymbol{\xi} t^r$  results in the algebraic equations

$$\begin{pmatrix} 5-r & -1 \\ 3 & 1-r \end{pmatrix} \begin{pmatrix} \xi_1 \\ \xi_2 \end{pmatrix} = \begin{pmatrix} 0 \\ 0 \end{pmatrix}.$$

For a nonzero solution, we must have  $\det(\mathbf{A} - r\mathbf{I}) = r^2 - 6r + 8 = 0$ . The roots of the characteristic equation are  $r_1 = 4$  and  $r_2 = 2$ . With  $r = 4$ , the system of equations reduces to  $\xi_1 - \xi_2 = 0$ . The corresponding eigenvector is  $\boldsymbol{\xi}^{(1)} = (1, 1)^T$ . For the case  $r = 2$ , the system is equivalent to the equation  $3\xi_1 - \xi_2 = 0$ . An eigenvector is  $\boldsymbol{\xi}^{(2)} = (1, 3)^T$ . It follows that

$$\mathbf{x}^{(1)} = \begin{pmatrix} 1 \\ 1 \end{pmatrix} t^4 \text{ and } \mathbf{x}^{(2)} = \begin{pmatrix} 1 \\ 3 \end{pmatrix} t^2.$$

The Wronskian of this solution set is  $W[\mathbf{x}^{(1)}, \mathbf{x}^{(2)}] = 2t^6$ . Thus the solutions are linearly independent for  $t > 0$ . Hence the general solution is

$$\mathbf{x} = c_1 \begin{pmatrix} 1 \\ 1 \end{pmatrix} t^4 + c_2 \begin{pmatrix} 1 \\ 3 \end{pmatrix} t^2.$$

22. As shown in Prob. 19, solution of the ODE requires analysis of the equations

$$\begin{pmatrix} 4-r & -3 \\ 8 & -6-r \end{pmatrix} \begin{pmatrix} \xi_1 \\ \xi_2 \end{pmatrix} = \begin{pmatrix} 0 \\ 0 \end{pmatrix}.$$

For a nonzero solution, we must have  $\det(\mathbf{A} - r\mathbf{I}) = r^2 + 2r = 0$ . The roots of the characteristic equation are  $r_1 = 0$  and  $r_2 = -2$ . For  $r = 0$ , the system of equations reduces to  $4\xi_1 = 3\xi_2$ . The corresponding eigenvector is  $\boldsymbol{\xi}^{(1)} = (3, 4)^T$ . Setting  $r = -2$  results in the single equation  $2\xi_1 - \xi_2 = 0$ . A corresponding eigenvector is  $\boldsymbol{\xi}^{(2)} = (1, 2)^T$ . It follows that

$$\mathbf{x}^{(1)} = \begin{pmatrix} 3 \\ 4 \end{pmatrix} \text{ and } \mathbf{x}^{(2)} = \begin{pmatrix} 1 \\ 2 \end{pmatrix} t^{-2}.$$

The Wronskian of this solution set is  $W[\mathbf{x}^{(1)}, \mathbf{x}^{(2)}] = 2t^{-2}$ . These solutions are linearly independent for  $t > 0$ . Hence the general solution is

$$\mathbf{x} = c_1 \begin{pmatrix} 3 \\ 4 \end{pmatrix} + c_2 \begin{pmatrix} 1 \\ 2 \end{pmatrix} t^{-2}.$$

23. Setting  $\mathbf{x} = \boldsymbol{\xi} t^r$  results in the algebraic equations

$$\begin{pmatrix} 3-r & -2 \\ 2 & -2-r \end{pmatrix} \begin{pmatrix} \xi_1 \\ \xi_2 \end{pmatrix} = \begin{pmatrix} 0 \\ 0 \end{pmatrix}.$$

For a nonzero solution, we must have  $\det(\mathbf{A} - r\mathbf{I}) = r^2 - r - 2 = 0$ . The roots of the characteristic equation are  $r_1 = 2$  and  $r_2 = -1$ . Setting  $r = 2$ , the system of equations reduces to  $\xi_1 - 2\xi_2 = 0$ . The corresponding eigenvector is  $\boldsymbol{\xi}^{(1)} = (2, 1)^T$ .

With  $r = -1$ , the system is equivalent to the equation  $2\xi_1 - \xi_2 = 0$ . An eigenvector is  $\xi^{(2)} = (1, 2)^T$ . It follows that

$$\mathbf{x}^{(1)} = \begin{pmatrix} 2 \\ 1 \end{pmatrix} t^2 \text{ and } \mathbf{x}^{(2)} = \begin{pmatrix} 1 \\ 2 \end{pmatrix} t^{-1}.$$

The Wronskian of this solution set is  $W[\mathbf{x}^{(1)}, \mathbf{x}^{(2)}] = 3t$ . Thus the solutions are linearly independent for  $t > 0$ . Hence the general solution is

$$\mathbf{x} = c_1 \begin{pmatrix} 2 \\ 1 \end{pmatrix} t^2 + c_2 \begin{pmatrix} 1 \\ 2 \end{pmatrix} t^{-1}.$$

24(a). The general solution is

$$\mathbf{x} = c_1 \begin{pmatrix} -1 \\ 2 \end{pmatrix} e^{-t} + c_2 \begin{pmatrix} 1 \\ 2 \end{pmatrix} e^{-2t}.$$

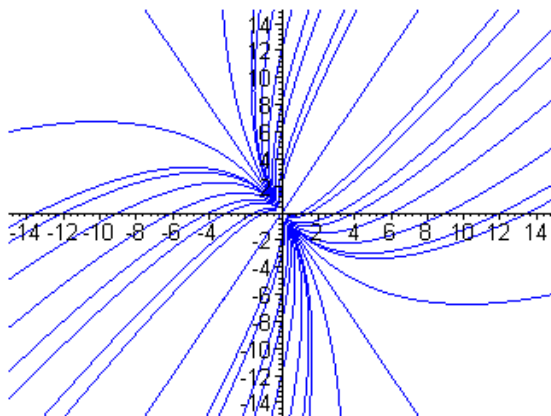

(b).

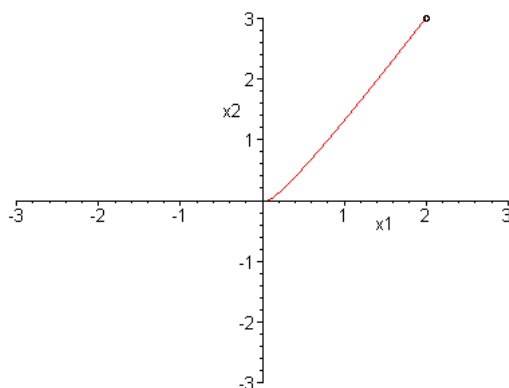

(c).

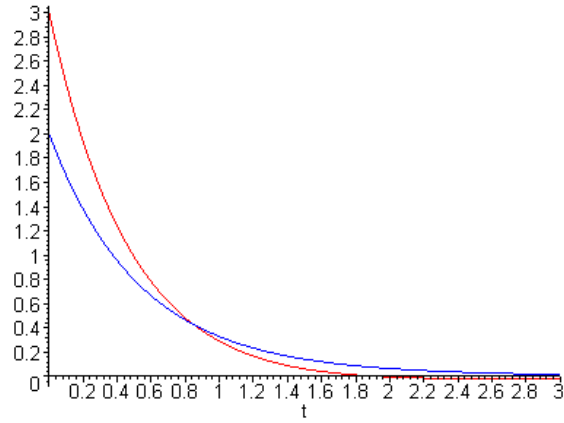

26(a). The general solution is

$$\mathbf{x} = c_1 \begin{pmatrix} -1 \\ 2 \end{pmatrix} e^{-t} + c_2 \begin{pmatrix} 1 \\ 2 \end{pmatrix} e^{2t}.$$

(b).

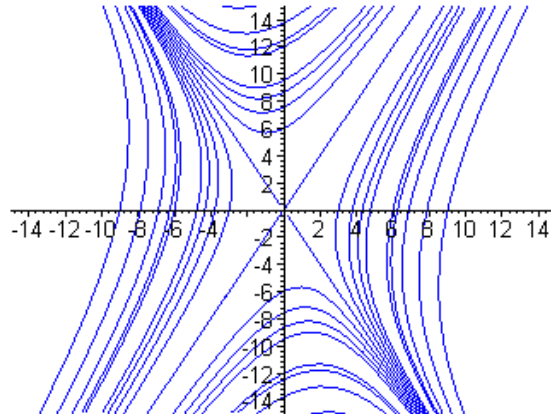

(b).

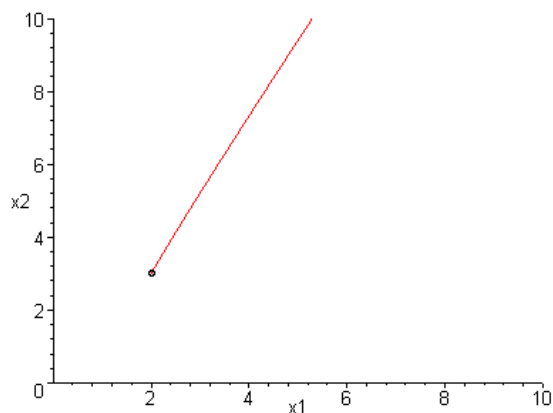

(c).

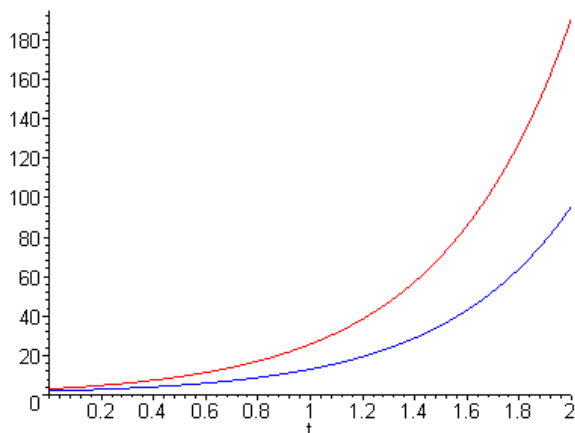

28(a). We note that  $(\mathbf{A} - r_i \mathbf{I})\boldsymbol{\xi}^{(i)} = \mathbf{0}$ , for  $i = 1, 2$ .

(b). It follows that  $(\mathbf{A} - r_2 \mathbf{I})\boldsymbol{\xi}^{(1)} = \mathbf{A} \boldsymbol{\xi}^{(1)} - r_2 \boldsymbol{\xi}^{(1)} = r_1 \boldsymbol{\xi}^{(1)} - r_2 \boldsymbol{\xi}^{(1)}$ .

(c). Suppose that  $\boldsymbol{\xi}^{(1)}$  and  $\boldsymbol{\xi}^{(2)}$  are linearly *dependent*. Then there exist constants  $c_1$  and  $c_2$ , not both zero, such that  $c_1 \boldsymbol{\xi}^{(1)} + c_2 \boldsymbol{\xi}^{(2)} = \mathbf{0}$ . Assume that  $c_1 \neq 0$ . It is clear that  $(\mathbf{A} - r_2 \mathbf{I})(c_1 \boldsymbol{\xi}^{(1)} + c_2 \boldsymbol{\xi}^{(2)}) = \mathbf{0}$ . On the other hand,

$$\begin{aligned} (\mathbf{A} - r_2 \mathbf{I})(c_1 \boldsymbol{\xi}^{(1)} + c_2 \boldsymbol{\xi}^{(2)}) &= c_1(r_1 - r_2)\boldsymbol{\xi}^{(1)} + \mathbf{0} \\ &= c_1(r_1 - r_2)\boldsymbol{\xi}^{(1)}. \end{aligned}$$

Since  $r_1 \neq r_2$ , we must have  $c_1 = 0$ , which leads to a contradiction.

(d). Note that  $(\mathbf{A} - r_1 \mathbf{I})\boldsymbol{\xi}^{(2)} = (r_2 - r_1)\boldsymbol{\xi}^{(2)}$ .

(e). Let  $n = 3$ , with  $r_1 \neq r_2 \neq r_3$ . Suppose that  $\boldsymbol{\xi}^{(1)}$ ,  $\boldsymbol{\xi}^{(2)}$  and  $\boldsymbol{\xi}^{(3)}$  are indeed linearly *dependent*. Then there exist constants  $c_1$ ,  $c_2$  and  $c_3$ , not all zero, such that

$$c_1 \boldsymbol{\xi}^{(1)} + c_2 \boldsymbol{\xi}^{(2)} + c_3 \boldsymbol{\xi}^{(3)} = \mathbf{0}.$$

Assume that  $c_1 \neq 0$ . It is clear that  $(\mathbf{A} - r_2 \mathbf{I})(c_1 \boldsymbol{\xi}^{(1)} + c_2 \boldsymbol{\xi}^{(2)} + c_3 \boldsymbol{\xi}^{(3)}) = \mathbf{0}$ . On the other hand,

$$(\mathbf{A} - r_2 \mathbf{I})(c_1 \boldsymbol{\xi}^{(1)} + c_2 \boldsymbol{\xi}^{(2)} + c_3 \boldsymbol{\xi}^{(3)}) = c_1(r_1 - r_2) \boldsymbol{\xi}^{(1)} + c_3(r_3 - r_2) \boldsymbol{\xi}^{(3)}.$$

It follows that  $c_1(r_1 - r_2) \boldsymbol{\xi}^{(1)} + c_3(r_3 - r_2) \boldsymbol{\xi}^{(3)} = \mathbf{0}$ . Based on the result of Part (a), which is actually not dependent on the value of  $n$ , the vectors  $\boldsymbol{\xi}^{(1)}$  and  $\boldsymbol{\xi}^{(3)}$  are linearly *independent*. Hence we must have  $c_1(r_1 - r_2) = c_3(r_3 - r_2) = 0$ , which leads to a contradiction.

29(a). Let  $x_1 = y$  and  $x_2 = y'$ . It follows that  $x_1' = x_2$  and

$$\begin{aligned} x_2' &= y'' \\ &= -\frac{1}{a}(c y + b y'). \end{aligned}$$

In terms of the new variables, we obtain the system of two first order ODEs

$$\begin{aligned} x_1' &= x_2 \\ x_2' &= -\frac{1}{a}(c x_1 + b x_2). \end{aligned}$$

(b). The coefficient matrix is given by

$$\mathbf{A} = \begin{pmatrix} 0 & 1 \\ -\frac{c}{a} & -\frac{b}{a} \end{pmatrix}.$$

Setting  $\mathbf{x} = \boldsymbol{\xi} e^{rt}$  results in the algebraic equations

$$\begin{pmatrix} -r & 1 \\ -\frac{c}{a} & -\frac{b}{a} - r \end{pmatrix} \begin{pmatrix} \xi_1 \\ \xi_2 \end{pmatrix} = \begin{pmatrix} 0 \\ 0 \end{pmatrix}.$$

For a nonzero solution, we must have

$$\det(\mathbf{A} - r \mathbf{I}) = r^2 + \frac{b}{a}r + \frac{c}{a} = 0.$$

Multiplying both sides of the equation by  $a$ , we obtain  $a r^2 + b r + c = 0$ .

30. Solution of the ODE requires analysis of the algebraic equations

$$\begin{pmatrix} 1 - r & 1 \\ 4 & -2 - r \end{pmatrix} \begin{pmatrix} \xi_1 \\ \xi_2 \end{pmatrix} = \begin{pmatrix} 0 \\ 0 \end{pmatrix}.$$

For a nonzero solution, we must have  $\det(\mathbf{A} - r \mathbf{I}) = 0$ . The characteristic equation is



$80r^2 + 24r + 1 = 0$ , with roots  $r_1 = -1/4$  and  $r_2 = -1/20$ . With  $r = -1/4$ , the system of equations reduces to  $2\xi_1 + \xi_2 = 0$ . The corresponding eigenvector is  $\xi^{(1)} = (1, -2)^T$ . Substitution of  $r = -1/20$  results in the equation  $2\xi_1 - 3\xi_2 = 0$ . A corresponding eigenvector is  $\xi^{(2)} = (3, 2)^T$ . Since the eigenvalues are *distinct*, the general solution is

$$\mathbf{x} = c_1 \begin{pmatrix} 1 \\ -2 \end{pmatrix} e^{-t/4} + c_2 \begin{pmatrix} 3 \\ 2 \end{pmatrix} e^{-t/20}.$$

Invoking the initial conditions, we obtain the system of equations

$$\begin{aligned} c_1 + 3c_2 &= -17 \\ -2c_1 + 2c_2 &= -21. \end{aligned}$$

Hence  $c_1 = 29/8$  and  $c_2 = -55/8$ , and the solution of the IVP is

$$\mathbf{x} = \frac{29}{8} \begin{pmatrix} 1 \\ -2 \end{pmatrix} e^{-t/4} - \frac{55}{8} \begin{pmatrix} 3 \\ 2 \end{pmatrix} e^{-t/20}.$$

(b).

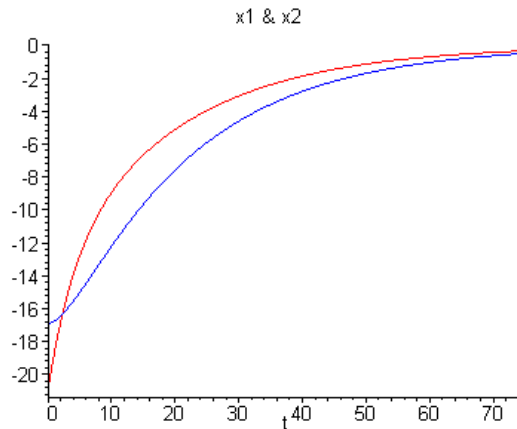

(c). Both functions are monotone increasing. It is easy to show that  $-0.5 \leq x_1(t) < 0$  and  $-0.5 \leq x_2(t) < 0$  provided that  $t > T \approx 74.39$ .

31(a). For  $\alpha = 1/2$ , solution of the ODE requires that

$$\begin{pmatrix} -1 - r & -1 \\ -1/2 & -1 - r \end{pmatrix} \begin{pmatrix} \xi_1 \\ \xi_2 \end{pmatrix} = \begin{pmatrix} 0 \\ 0 \end{pmatrix}.$$

The characteristic equation is  $2r^2 + 4r + 1 = 0$ , with roots  $r_1 = -1 + 1/\sqrt{2}$  and  $r_2 = -1 - 1/\sqrt{2}$ . With  $r = -1 + 1/\sqrt{2}$ , the system of equations reduces to  $\sqrt{2}\xi_1 + 2\xi_2 = 0$ . The corresponding eigenvector is  $\xi^{(1)} = (-\sqrt{2}, 1)^T$ . Substitution

of  $r = -1 - 1/\sqrt{2}$  results in the equation  $\sqrt{2}\xi_1 - 2\xi_2 = 0$ . An eigenvector is  $\xi^{(2)} = (\sqrt{2}, 1)^T$ . The general solution is

$$\mathbf{x} = c_1 \begin{pmatrix} -\sqrt{2} \\ 1 \end{pmatrix} e^{(-2+\sqrt{2})t/2} + c_2 \begin{pmatrix} \sqrt{2} \\ 1 \end{pmatrix} e^{(-2-\sqrt{2})t/2}.$$

The eigenvalues are distinct and both *negative*. The equilibrium point is a stable *node*.

(b). For  $\alpha = 2$ , the characteristic equation is given by  $r^2 + 2r - 1 = 0$ , with roots  $r_1 = -1 + \sqrt{2}$  and  $r_2 = -1 - \sqrt{2}$ . With  $r = -1 + \sqrt{2}$ , the system of equations reduces to  $\sqrt{2}\xi_1 + \xi_2 = 0$ . The corresponding eigenvector is  $\xi^{(1)} = (1, -\sqrt{2})^T$ .

Substitution of  $r = -1 - \sqrt{2}$  results in the equation  $\sqrt{2}\xi_1 - \xi_2 = 0$ . An eigenvector is  $\xi^{(2)} = (1, \sqrt{2})^T$ . The general solution is

$$\mathbf{x} = c_1 \begin{pmatrix} 1 \\ -\sqrt{2} \end{pmatrix} e^{(-1+\sqrt{2})t} + c_2 \begin{pmatrix} 1 \\ \sqrt{2} \end{pmatrix} e^{(-1-\sqrt{2})t}.$$

The eigenvalues are of opposite sign, hence the equilibrium point is a *saddle point*.

32. The system of differential equations is

$$\frac{d}{dt} \begin{pmatrix} I \\ V \end{pmatrix} = \begin{pmatrix} -\frac{1}{2} & -\frac{1}{2} \\ \frac{3}{2} & -\frac{5}{2} \end{pmatrix} \begin{pmatrix} I \\ V \end{pmatrix}.$$

Solution of the system requires analysis of the eigenvalue problem

$$\begin{pmatrix} -\frac{1}{2} - r & -\frac{1}{2} \\ \frac{3}{2} & -\frac{5}{2} - r \end{pmatrix} \begin{pmatrix} \xi_1 \\ \xi_2 \end{pmatrix} = \begin{pmatrix} 0 \\ 0 \end{pmatrix}.$$

The characteristic equation is  $r^2 + 3r + 2$ , with roots  $r_1 = -1$  and  $r_2 = -2$ . With  $r = -1$ , the equations reduce to  $\xi_1 - \xi_2 = 0$ . A corresponding eigenvector is given by  $\xi^{(1)} = (1, 1)^T$ . Setting  $r = -2$ , the system reduces to the equation  $3\xi_1 - \xi_2 = 0$ . An eigenvector is  $\xi^{(2)} = (1, 3)^T$ . Hence the general solution is

$$\begin{pmatrix} I \\ V \end{pmatrix} = c_1 \begin{pmatrix} 1 \\ 1 \end{pmatrix} e^{-t} + c_2 \begin{pmatrix} 1 \\ 3 \end{pmatrix} e^{-2t}.$$

(b). The eigenvalues are distinct and both *negative*. We find that the equilibrium point  $(0, 0)$  is a stable *node*. Hence all solutions converge to  $(0, 0)$ .

33(a). Solution of the ODE requires analysis of the algebraic equations

$$\begin{pmatrix} -\frac{R_1}{L} - r & -\frac{1}{L} \\ \frac{1}{C} & -\frac{1}{CR_2} - r \end{pmatrix} \begin{pmatrix} \xi_1 \\ \xi_2 \end{pmatrix} = \begin{pmatrix} 0 \\ 0 \end{pmatrix}.$$

The characteristic equation is

$$r^2 + \left( \frac{L + CR_1R_2}{LCR_2} \right) r + \frac{R_1 + R_2}{LCR_2} = 0.$$

The eigenvectors are *real* and *distinct*, provided that the *discriminant* is positive. That is,

$$\left( \frac{L + CR_1R_2}{LCR_2} \right)^2 - 4 \left( \frac{R_1 + R_2}{LCR_2} \right) > 0,$$

which simplifies to the condition

$$\left( \frac{1}{CR_2} - \frac{R_1}{L} \right)^2 - \frac{4}{LC} > 0.$$

(b). The parameters in the ODE are all positive. Observe that the *sum* of the roots is

$$-\frac{L + CR_1R_2}{LCR_2} < 0.$$

Also, the *product* of the roots is

$$\frac{R_1 + R_2}{LCR_2} > 0.$$

It follows that *both* roots are negative. Hence the *equilibrium solution*  $I = 0, V = 0$  represents a stable node, which attracts *all* solutions.

(c). If the condition in Part (a) is not satisfied, that is,

$$\left( \frac{1}{CR_2} - \frac{R_1}{L} \right)^2 - \frac{4}{LC} \leq 0,$$

then the *real part* of the eigenvalues is

$$\operatorname{Re}(r_{1,2}) = -\frac{L + CR_1R_2}{2LCR_2}.$$

As long as the parameters are *all* positive, then the solutions will still converge to the equilibrium point  $(0, 0)$ .

## Section 7.6

2. Setting  $\mathbf{x} = \boldsymbol{\xi} e^{rt}$  results in the algebraic equations

$$\begin{pmatrix} -1-r & -4 \\ 1 & -1-r \end{pmatrix} \begin{pmatrix} \xi_1 \\ \xi_2 \end{pmatrix} = \begin{pmatrix} 0 \\ 0 \end{pmatrix}.$$

For a nonzero solution, we require that  $\det(\mathbf{A} - r\mathbf{I}) = r^2 + 2r + 5 = 0$ . The roots of the characteristic equation are  $r = -1 \pm 2i$ . Substituting  $r = -1 - 2i$ , the two equations reduce to  $\xi_1 + 2i\xi_2 = 0$ . The two eigenvectors are  $\boldsymbol{\xi}^{(1)} = (-2i, 1)^T$  and  $\boldsymbol{\xi}^{(2)} = (2i, 1)^T$ . Hence one of the *complex-valued* solutions is given by

$$\begin{aligned} \mathbf{x}^{(1)} &= \begin{pmatrix} -2i \\ 1 \end{pmatrix} e^{-(1+2i)t} \\ &= \begin{pmatrix} -2i \\ 1 \end{pmatrix} e^{-t} (\cos 2t - i \sin 2t) \\ &= e^{-t} \begin{pmatrix} -2 \sin 2t \\ \cos 2t \end{pmatrix} + i e^{-t} \begin{pmatrix} -2 \cos 2t \\ -\sin 2t \end{pmatrix}. \end{aligned}$$

Based on the real and imaginary parts of this solution, the general solution is

$$\mathbf{x} = c_1 e^{-t} \begin{pmatrix} -2 \sin 2t \\ \cos 2t \end{pmatrix} + c_2 e^{-t} \begin{pmatrix} 2 \cos 2t \\ \sin 2t \end{pmatrix}.$$

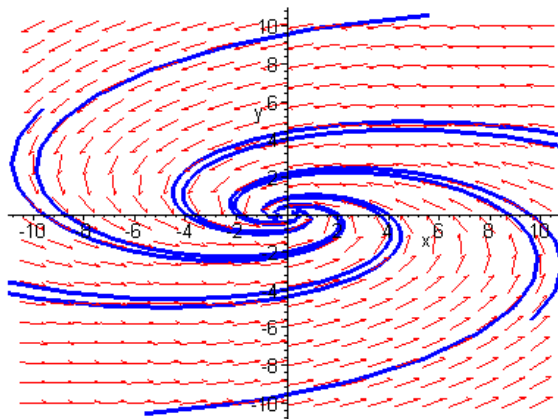

3. Solution of the ODEs is based on the analysis of the algebraic equations

$$\begin{pmatrix} 2-r & -5 \\ 1 & -2-r \end{pmatrix} \begin{pmatrix} \xi_1 \\ \xi_2 \end{pmatrix} = \begin{pmatrix} 0 \\ 0 \end{pmatrix}.$$

For a nonzero solution, we require that  $\det(\mathbf{A} - r\mathbf{I}) = r^2 + 1 = 0$ . The roots of the characteristic equation are  $r = \pm i$ . Setting  $r = i$ , the equations are equivalent to  $\xi_1 - (2+i)\xi_2 = 0$ . The eigenvectors are  $\boldsymbol{\xi}^{(1)} = (2+i, 1)^T$  and  $\boldsymbol{\xi}^{(2)} = (2-i, 1)^T$ . Hence one of the *complex-valued* solutions is given by

$$\begin{aligned}
 \mathbf{x}^{(1)} &= \begin{pmatrix} 2+i \\ 1 \end{pmatrix} e^{it} \\
 &= \begin{pmatrix} 2+i \\ 1 \end{pmatrix} (\cos t + i \sin t) \\
 &= \begin{pmatrix} 2 \cos t - \sin t \\ \cos t \end{pmatrix} + i \begin{pmatrix} \cos t + 2 \sin t \\ \sin t \end{pmatrix}.
 \end{aligned}$$

Therefore the general solution is

$$\mathbf{x} = c_1 \begin{pmatrix} 2 \cos t - \sin t \\ \cos t \end{pmatrix} + c_2 \begin{pmatrix} \cos t + 2 \sin t \\ \sin t \end{pmatrix}.$$

The solution may also be written as

$$\mathbf{x} = c_1 \begin{pmatrix} 5 \cos t \\ 2 \cos t + \sin t \end{pmatrix} + c_2 \begin{pmatrix} 5 \sin t \\ -\cos t + 2 \sin t \end{pmatrix}.$$

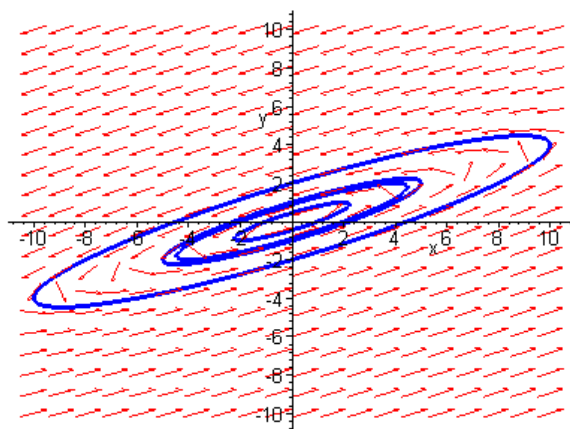

4. Setting  $\mathbf{x} = \boldsymbol{\xi} e^{rt}$  results in the algebraic equations

$$\begin{pmatrix} 2-r & -5/2 \\ 9/5 & -1-r \end{pmatrix} \begin{pmatrix} \xi_1 \\ \xi_2 \end{pmatrix} = \begin{pmatrix} 0 \\ 0 \end{pmatrix}.$$

For a nonzero solution, we require that  $\det(\mathbf{A} - r\mathbf{I}) = r^2 - r + \frac{5}{2} = 0$ . The roots of the characteristic equation are  $r = (1 \pm 3i)/2$ . With  $r = (1 + 3i)/2$ , the equations reduce to the single equation  $(3 - 3i)\xi_1 - 5\xi_2 = 0$ . The corresponding eigenvector is given by  $\boldsymbol{\xi}^{(1)} = (5, 3 - 3i)^T$ . Hence one of the *complex-valued* solutions is

$$\begin{aligned}
 \mathbf{x}^{(1)} &= \begin{pmatrix} 5 \\ 3 - 3i \end{pmatrix} e^{(1+3i)t/2} \\
 &= \begin{pmatrix} 2 + i \\ 1 \end{pmatrix} e^{t/2} \left( \cos \frac{3}{2}t + i \sin \frac{3}{2}t \right) \\
 &= e^{t/2} \begin{pmatrix} 2 \cos \frac{3}{2}t - \sin \frac{3}{2}t \\ \cos \frac{3}{2}t \end{pmatrix} + i e^{t/2} \begin{pmatrix} \cos \frac{3}{2}t + 2 \sin \frac{3}{2}t \\ \sin \frac{3}{2}t \end{pmatrix}.
 \end{aligned}$$

The general solution is

$$\mathbf{x} = c_1 e^{t/2} \begin{pmatrix} 2 \cos \frac{3}{2}t - \sin \frac{3}{2}t \\ \cos \frac{3}{2}t \end{pmatrix} + c_2 e^{t/2} \begin{pmatrix} \cos \frac{3}{2}t + 2 \sin \frac{3}{2}t \\ \sin \frac{3}{2}t \end{pmatrix}.$$

The solution may also be written as

$$\mathbf{x} = c_1 e^{t/2} \begin{pmatrix} 5 \cos \frac{3}{2}t \\ 3 \cos \frac{3}{2}t + 3 \sin \frac{3}{2}t \end{pmatrix} + c_2 e^{t/2} \begin{pmatrix} 5 \sin \frac{3}{2}t \\ -3 \cos \frac{3}{2}t + 3 \sin \frac{3}{2}t \end{pmatrix}.$$

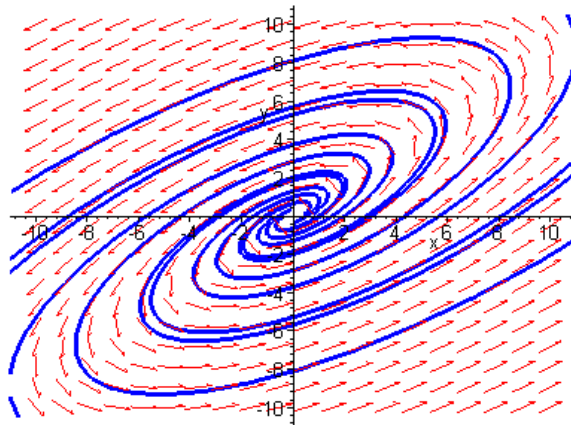

5. Setting  $\mathbf{x} = \boldsymbol{\xi} t^r$  results in the algebraic equations

$$\begin{pmatrix} 1 - r & -1 \\ 5 & -3 - r \end{pmatrix} \begin{pmatrix} \xi_1 \\ \xi_2 \end{pmatrix} = \begin{pmatrix} 0 \\ 0 \end{pmatrix}.$$

The characteristic equation is  $r^2 + 2r + 2 = 0$ , with roots  $r = -1 \pm i$ . Substituting  $r = -1 - i$  reduces the system of equations to  $(2 + i)\xi_1 - \xi_2 = 0$ . The eigenvectors are  $\boldsymbol{\xi}^{(1)} = (1, 2 + i)^T$  and  $\boldsymbol{\xi}^{(2)} = (1, 2 - i)^T$ . Hence one of the *complex-valued* solutions is given by

$$\begin{aligned}
\mathbf{x}^{(1)} &= \begin{pmatrix} 1 \\ 2+i \end{pmatrix} e^{-(1+i)t} \\
&= \begin{pmatrix} 1 \\ 2+i \end{pmatrix} e^{-t} (\cos t - i \sin t) \\
&= e^{-t} \begin{pmatrix} \cos t \\ 2 \cos t + \sin t \end{pmatrix} + i e^{-t} \begin{pmatrix} -\sin t \\ \cos t - 2 \sin t \end{pmatrix}.
\end{aligned}$$

The general solution is

$$\mathbf{x} = c_1 e^{-t} \begin{pmatrix} \cos t \\ 2 \cos t + \sin t \end{pmatrix} + c_2 e^{-t} \begin{pmatrix} \sin t \\ -\cos t + 2 \sin t \end{pmatrix}.$$

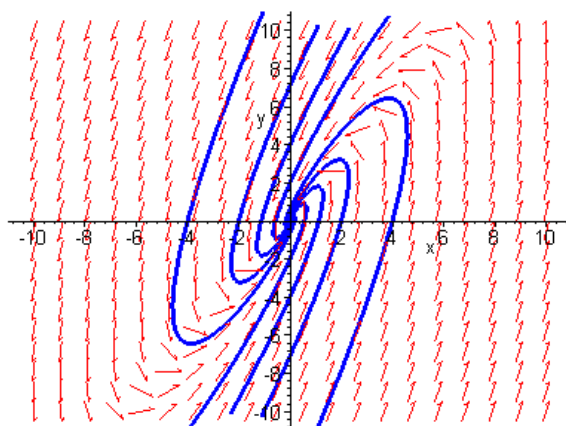

6. Solution of the ODEs is based on the analysis of the algebraic equations

$$\begin{pmatrix} 1-r & 2 \\ -5 & -1-r \end{pmatrix} \begin{pmatrix} \xi_1 \\ \xi_2 \end{pmatrix} = \begin{pmatrix} 0 \\ 0 \end{pmatrix}.$$

For a nonzero solution, we require that  $\det(\mathbf{A} - r\mathbf{I}) = r^2 + 9 = 0$ . The roots of the characteristic equation are  $r = \pm 3i$ . Setting  $r = 3i$ , the two equations reduce to  $(1 - 3i)\xi_1 + 2\xi_2 = 0$ . The corresponding eigenvector is  $\boldsymbol{\xi}^{(1)} = (-2, 1 - 3i)^T$ . Hence one of the *complex-valued* solutions is given by

$$\begin{aligned}
\mathbf{x}^{(1)} &= \begin{pmatrix} -2 \\ 1-3i \end{pmatrix} e^{3it} \\
&= \begin{pmatrix} -2 \\ 1-3i \end{pmatrix} (\cos 3t + i \sin 3t) \\
&= \begin{pmatrix} -2 \cos 3t \\ \cos 3t + 3 \sin 3t \end{pmatrix} + i \begin{pmatrix} -2 \sin 3t \\ -3 \cos 3t + \sin 3t \end{pmatrix}.
\end{aligned}$$

The general solution is

$$\mathbf{x} = c_1 \begin{pmatrix} -2 \cos 3t \\ \cos 3t + 3 \sin 3t \end{pmatrix} + c_2 \begin{pmatrix} 2 \sin 3t \\ 3 \cos 3t - \sin 3t \end{pmatrix}.$$

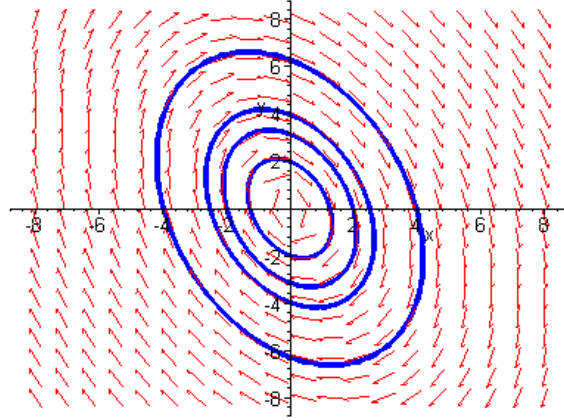

8. The eigensystem is obtained from analysis of the equation

$$\begin{pmatrix} -3-r & 0 & 2 \\ 1 & -1-r & 0 \\ -2 & -1 & -r \end{pmatrix} \begin{pmatrix} \xi_1 \\ \xi_2 \\ \xi_3 \end{pmatrix} = \begin{pmatrix} 0 \\ 0 \\ 0 \end{pmatrix}.$$

The characteristic equation of the coefficient matrix is  $r^3 + 4r^2 + 7r + 6 = 0$ , with roots  $r_1 = -2$ ,  $r_2 = -1 - \sqrt{2}i$  and  $r_3 = -1 + \sqrt{2}i$ . Setting  $r = -2$ , the equations reduce to

$$\begin{aligned} -\xi_1 + 2\xi_3 &= 0 \\ \xi_1 + \xi_2 &= 0. \end{aligned}$$

The corresponding eigenvector is  $\boldsymbol{\xi}^{(1)} = (2, -2, 1)^T$ . With  $r = -1 - \sqrt{2}i$ , the system of equations is equivalent to

$$\begin{aligned} (2 - i\sqrt{2})\xi_1 - 2\xi_3 &= 0 \\ \xi_1 + i\sqrt{2}\xi_2 &= 0. \end{aligned}$$

An eigenvector is given by  $\boldsymbol{\xi}^{(2)} = (-i\sqrt{2}, 1, -1 - i\sqrt{2})^T$ . Hence one of the *complex-valued* solutions is given by



$$\begin{aligned}
\mathbf{x}^{(2)} &= \begin{pmatrix} -i\sqrt{2} \\ 1 \\ -1 - i\sqrt{2} \end{pmatrix} e^{-(1+i\sqrt{2})it} \\
&= \begin{pmatrix} -i\sqrt{2} \\ 1 \\ -1 - i\sqrt{2} \end{pmatrix} e^{-t} (\cos \sqrt{2}t - i \sin \sqrt{2}t) \\
&= e^{-t} \begin{pmatrix} -\sqrt{2} \sin \sqrt{2}t \\ \cos \sqrt{2}t \\ -\cos \sqrt{2}t - \sqrt{2} \sin \sqrt{2}t \end{pmatrix} + ie^{-t} \begin{pmatrix} -\sqrt{2} \cos \sqrt{2}t \\ -\sin \sqrt{2}t \\ -\sqrt{2} \cos \sqrt{2}t - \sin \sqrt{2}t \end{pmatrix}.
\end{aligned}$$

The other complex-valued solution is  $\mathbf{x}^{(3)} = \overline{\boldsymbol{\xi}^{(2)}} e^{r_3 t}$ . The general solution is

$$\begin{aligned}
\mathbf{x} &= c_1 \begin{pmatrix} 2 \\ -2 \\ 1 \end{pmatrix} e^{-2t} + \\
&+ c_2 e^{-t} \begin{pmatrix} \sqrt{2} \sin \sqrt{2}t \\ -\cos \sqrt{2}t \\ \cos \sqrt{2}t + \sqrt{2} \sin \sqrt{2}t \end{pmatrix} + c_3 e^{-t} \begin{pmatrix} \sqrt{2} \cos \sqrt{2}t \\ \sin \sqrt{2}t \\ \sqrt{2} \cos \sqrt{2}t + \sin \sqrt{2}t \end{pmatrix}.
\end{aligned}$$

It is easy to see that all solutions converge to the equilibrium point  $(0, 0, 0)$ .

10. Solution of the system of ODEs requires that

$$\begin{pmatrix} -3 - r & 2 \\ -1 & -1 - r \end{pmatrix} \begin{pmatrix} \xi_1 \\ \xi_2 \end{pmatrix} = \begin{pmatrix} 0 \\ 0 \end{pmatrix}.$$

The characteristic equation is  $r^2 + 4r + 5 = 0$ , with roots  $r = -2 \pm i$ . Substituting  $r = -2 + i$ , the equations are equivalent to  $\xi_1 - (1 - i)\xi_2 = 0$ . The corresponding eigenvector is  $\boldsymbol{\xi}^{(1)} = (1 - i, 1)^T$ . One of the *complex-valued* solutions is given by

$$\begin{aligned}
\mathbf{x}^{(1)} &= \begin{pmatrix} 1 - i \\ 1 \end{pmatrix} e^{(-2+i)t} \\
&= \begin{pmatrix} 1 - i \\ 1 \end{pmatrix} e^{-2t} (\cos t + i \sin t) \\
&= e^{-2t} \begin{pmatrix} \cos t + \sin t \\ \cos t \end{pmatrix} + ie^{-2t} \begin{pmatrix} -\cos t + \sin t \\ \sin t \end{pmatrix}.
\end{aligned}$$

Hence the general solution is

$$\mathbf{x} = c_1 e^{-2t} \begin{pmatrix} \cos t + \sin t \\ \cos t \end{pmatrix} + c_2 e^{-2t} \begin{pmatrix} -\cos t + \sin t \\ \sin t \end{pmatrix}.$$

Invoking the initial conditions, we obtain the system of equations

$$\begin{aligned}
c_1 - c_2 &= 1 \\
c_1 &= -2.
\end{aligned}$$

Solving for the coefficients, the solution of the initial value problem is

$$\begin{aligned} \mathbf{x} &= -2e^{-2t} \begin{pmatrix} \cos t + \sin t \\ \cos t \end{pmatrix} - 3e^{-2t} \begin{pmatrix} -\cos t + \sin t \\ \sin t \end{pmatrix} \\ &= e^{-2t} \begin{pmatrix} \cos t - 5 \sin t \\ -2 \cos t - 3 \sin t \end{pmatrix}. \end{aligned}$$

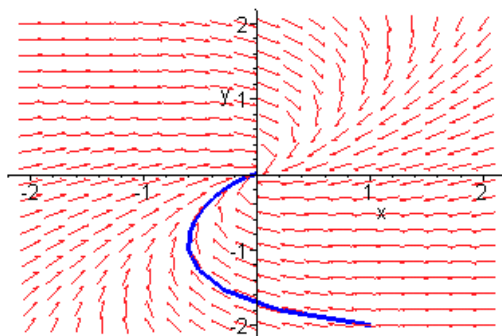

11(a). With  $\mathbf{x}(0) = (2, 2)^T$ , the solution is

$$\mathbf{x} = e^{-t/4} \begin{pmatrix} 2 \cos t - 2 \sin t \\ 2 \cos t \end{pmatrix}.$$

11(b).

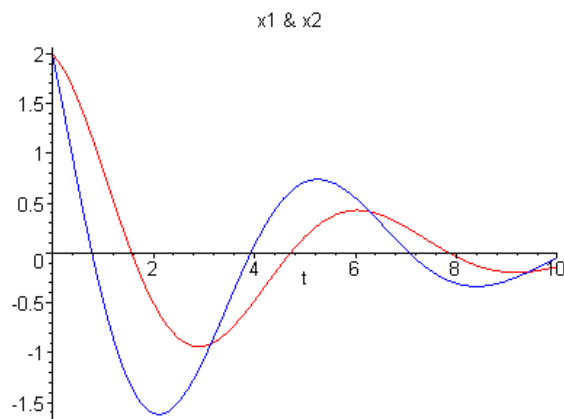

11(c).

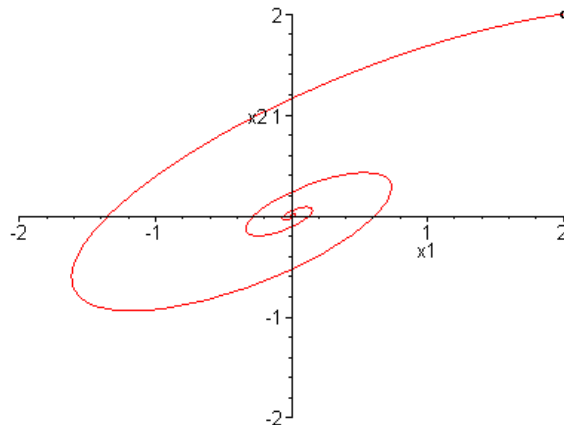

12. Solution of the ODEs is based on the analysis of the algebraic equations

$$\begin{pmatrix} -\frac{4}{5} - r & 2 \\ -1 & \frac{6}{5} - r \end{pmatrix} \begin{pmatrix} \xi_1 \\ \xi_2 \end{pmatrix} = \begin{pmatrix} 0 \\ 0 \end{pmatrix}.$$

The characteristic equation is  $25r^2 - 10r + 26 = 0$ , with roots  $r = \frac{1}{5} \pm i$ . Setting  $r = \frac{1}{5} + i$ , the two equations reduce to  $\xi_1 - (1 - i)\xi_2 = 0$ . The corresponding eigenvector is  $\boldsymbol{\xi}^{(1)} = (1 - i, 1)^T$ . One of the *complex-valued* solutions is given by

$$\begin{aligned} \mathbf{x}^{(1)} &= \begin{pmatrix} 1 - i \\ 1 \end{pmatrix} e^{(\frac{1}{5} + i)t} \\ &= \begin{pmatrix} 1 - i \\ 1 \end{pmatrix} e^{t/5} (\cos t + i \sin t) \\ &= e^{t/5} \begin{pmatrix} \cos t + \sin t \\ \cos t \end{pmatrix} + i e^{t/5} \begin{pmatrix} -\cos t + \sin t \\ \sin t \end{pmatrix}. \end{aligned}$$

Hence the general solution is

$$\mathbf{x} = c_1 e^{t/5} \begin{pmatrix} \cos t + \sin t \\ \cos t \end{pmatrix} + c_2 e^{t/5} \begin{pmatrix} -\cos t + \sin t \\ \sin t \end{pmatrix}.$$

(b). Let  $\mathbf{x}(0) = (x_1^0, x_2^0)^T$ . The solution of the initial value problem is

$$\begin{aligned} \mathbf{x} &= x_2^0 e^{t/5} \begin{pmatrix} \cos t + \sin t \\ \cos t \end{pmatrix} + (x_2^0 - x_1^0) e^{t/5} \begin{pmatrix} -\cos t + \sin t \\ \sin t \end{pmatrix} \\ &= e^{t/5} \begin{pmatrix} x_1^0 \cos t + (2x_2^0 - x_1^0) \sin t \\ x_2^0 \cos t + (x_2^0 - x_1^0) \sin t \end{pmatrix}. \end{aligned}$$

With  $\mathbf{x}(0) = (1, 2)^T$ , the solution is

$$\mathbf{x} = e^{t/5} \begin{pmatrix} \cos t + 3 \sin t \\ 2 \cos t + \sin t \end{pmatrix}.$$

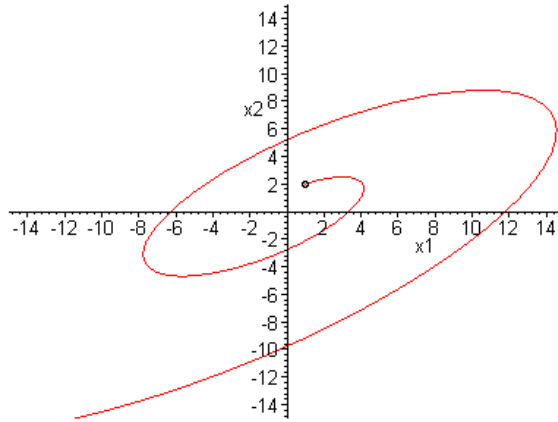

(c).

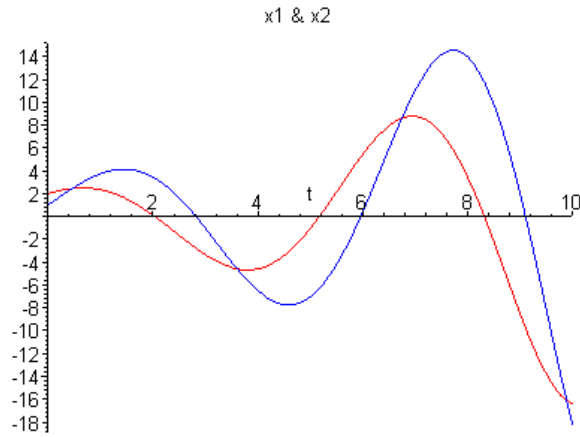

(d).

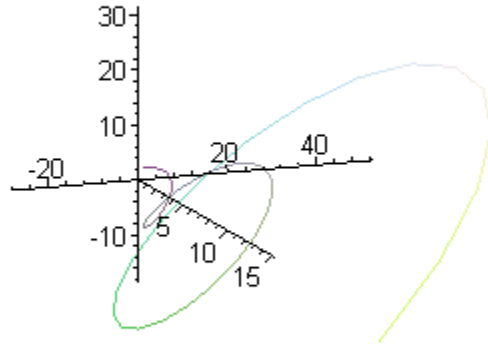

13(a). The characteristic equation of the coefficient matrix is  $r^2 - 2\alpha r + 1 + \alpha^2$ , with roots  $r = \alpha \pm i$ .

(b). When  $\alpha < 0$  and  $\alpha > 0$ , the equilibrium point  $(0, 0)$  is a *stable* spiral and an *unstable* spiral, respectively. The equilibrium point is a *center* when  $\alpha = 0$ .

(c).

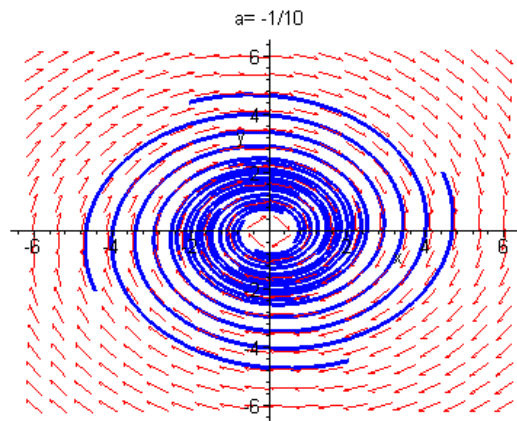

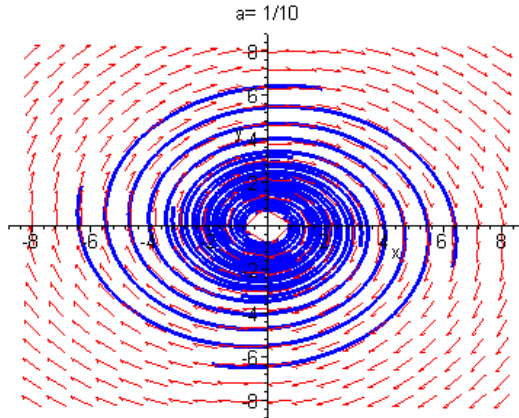

14(a). The roots of the characteristic equation,  $r^2 - \alpha r + 5 = 0$ , are

$$r_{1,2} = \frac{\alpha}{2} \pm \frac{1}{2} \sqrt{\alpha^2 - 20} .$$

(b). Note that the roots are *complex* when  $-\sqrt{20} < \alpha < \sqrt{20}$ . For the case when  $\alpha \in (-\sqrt{20}, 0)$ , the equilibrium point  $(0, 0)$  is a *stable spiral*. On the other hand, when  $\alpha \in (0, \sqrt{20})$ , the equilibrium point is an *unstable spiral*. For the case  $\alpha = 0$ , the roots are purely imaginary, so the equilibrium point is a *center*. When  $\alpha^2 > 20$ , the roots are *real and distinct*. The equilibrium point becomes a *node*, with its stability dependent on the sign of  $\alpha$ . Finally, the case  $\alpha^2 = 20$  marks the transition from spirals to nodes.

(c).

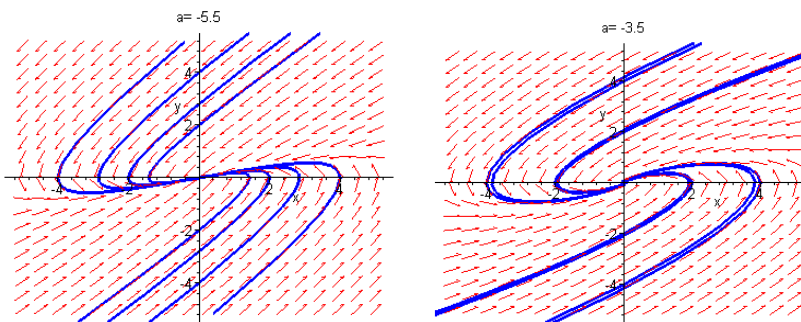

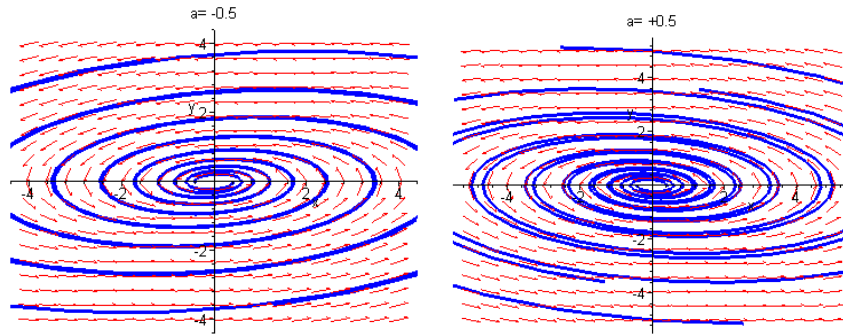

17. The characteristic equation of the coefficient matrix is  $r^2 + 2r + 1 + \alpha = 0$ , with roots given formally as  $r_{1,2} = -1 \pm \sqrt{-\alpha}$ . The roots are *real* provided that  $\alpha \leq 0$ . First note that the *sum* of the roots is  $-2$  and the *product* of the roots is  $1 + \alpha$ . For *negative* values of  $\alpha$ , the roots are distinct, with one always negative. When  $\alpha < -1$ , the roots have *opposite* signs. Hence the equilibrium point is a *saddle*. For the case  $-1 < \alpha < 0$ , the roots are both *negative*, and the equilibrium point is a *stable node*.  $\alpha = -1$  represents a transition from saddle to node. When  $\alpha = 0$ , both roots are equal. For the case  $\alpha > 0$ , the roots are complex conjugates, with negative real part. Hence the equilibrium point is a *stable spiral*.

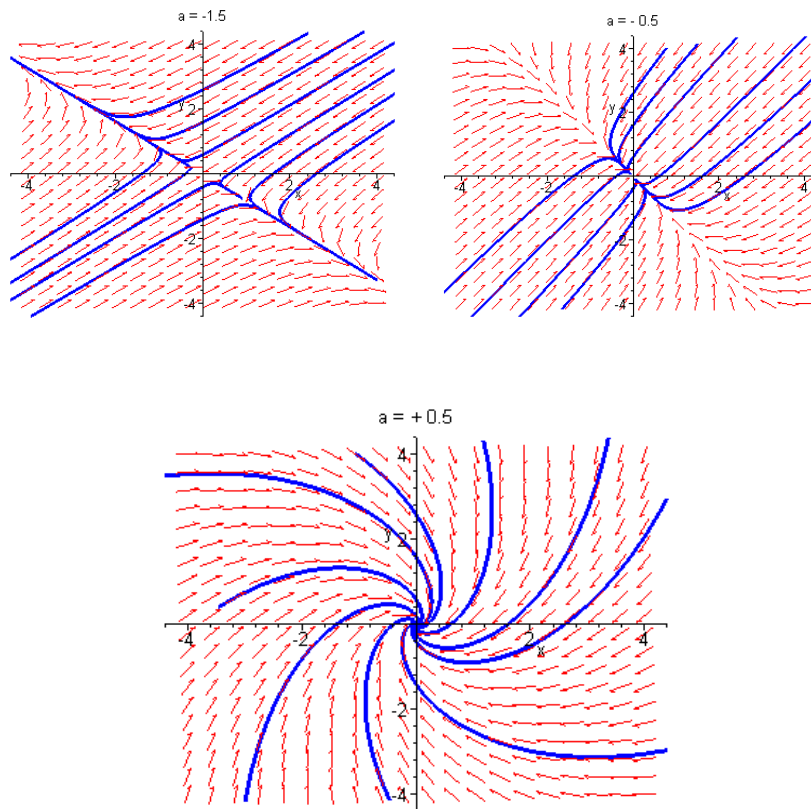

19. The characteristic equation for the system is given by

$$r^2 + (4 - \alpha)r + 10 - 4\alpha = 0.$$

The roots are

$$r_{1,2} = -2 + \frac{\alpha}{2} \pm \sqrt{\alpha^2 + 8\alpha - 24}.$$

First note that the roots are *complex* when  $-4 - 2\sqrt{10} < \alpha < -4 + 2\sqrt{10}$ . We also find that when  $-4 - 2\sqrt{10} < \alpha < 2$ , the equilibrium point is a *stable spiral*. For the case  $\alpha = 2$ , the equilibrium point is a *center*. When  $2 < \alpha < -4 + 2\sqrt{10}$ , the equilibrium point is an *unstable spiral*. For all other cases, the roots are *real*. When  $\alpha > 2.5$ , the roots have *opposite* signs, with the equilibrium point being a *saddle*. For the case  $-4 + 2\sqrt{10} < \alpha < 2.5$ , the roots are both *positive*, and the equilibrium point is an *unstable node*. Finally, when  $\alpha < -4 - 2\sqrt{10}$ , both roots are negative, with the equilibrium point being a *stable node*.

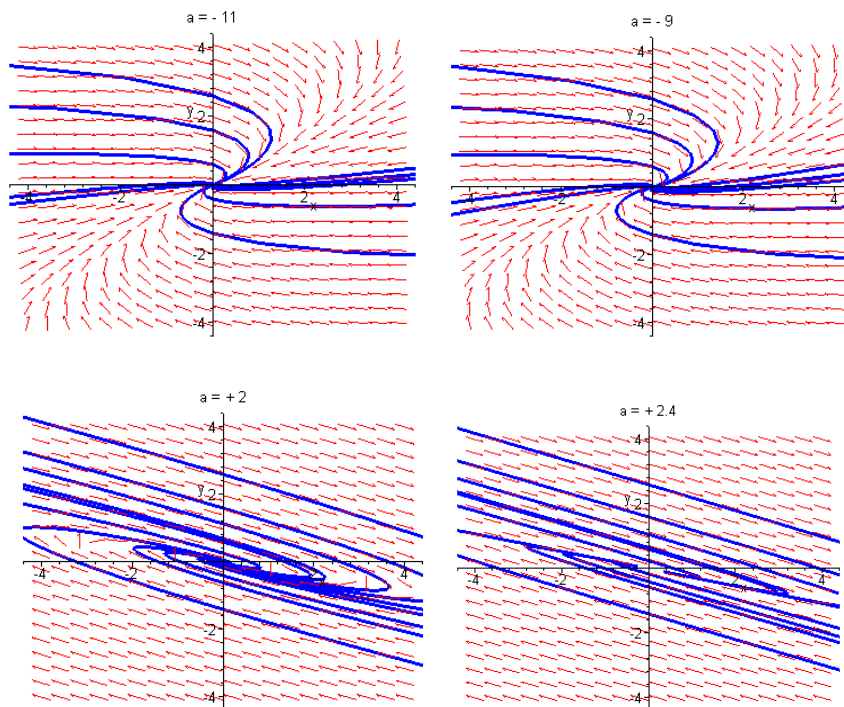



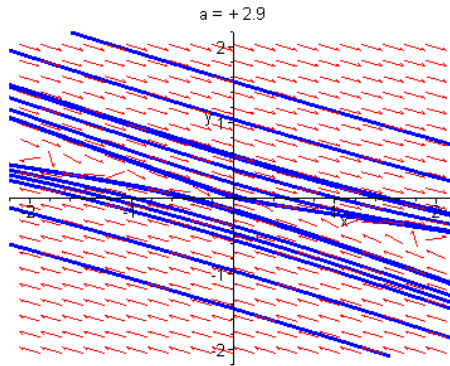

20. The characteristic equation is  $r^2 + 2r - (24 + 8\alpha) = 0$ , with roots

$$r_{1,2} = -1 \pm \sqrt{25 + 8\alpha}.$$

The roots are *complex* when  $\alpha < -25/8$ . Since the real part is negative, the origin is a stable *spiral*. Otherwise the roots are real. When  $-25 < \alpha < -3$ , both roots are negative, and hence the equilibrium point is a stable *node*. For  $\alpha > -3$ , the roots are of opposite sign and the origin is a *saddle*.

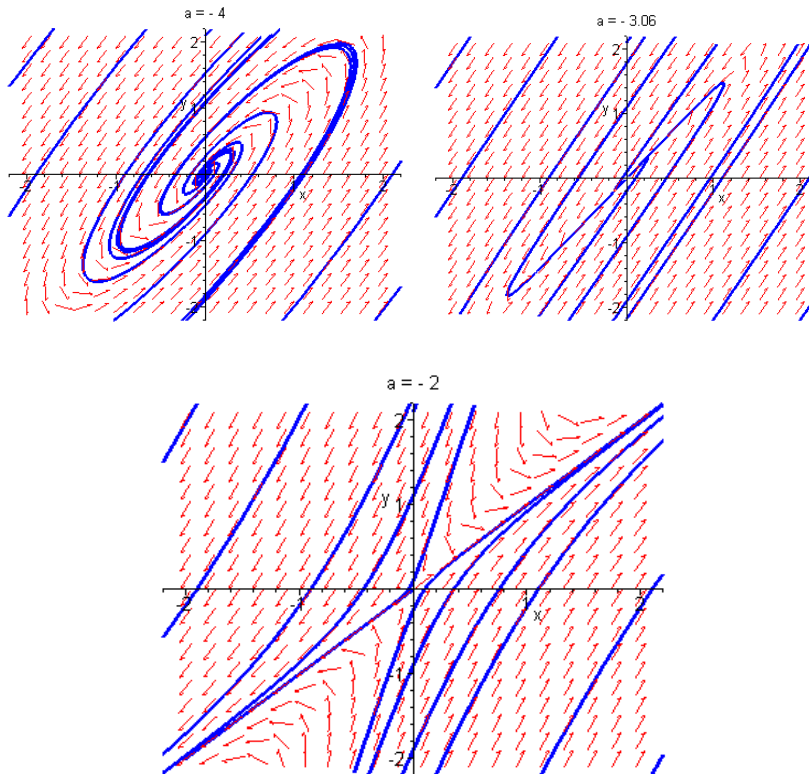

22. Based on the method in Prob. 19 of Section 7.5, setting  $\mathbf{x} = \boldsymbol{\xi} t^r$  results in the

algebraic equations

$$\begin{pmatrix} 2-r & -5 \\ 1 & -2-r \end{pmatrix} \begin{pmatrix} \xi_1 \\ \xi_2 \end{pmatrix} = \begin{pmatrix} 0 \\ 0 \end{pmatrix}.$$

The characteristic equation for the system is  $r^2 + 1 = 0$ , with roots  $r_{1,2} = \pm i$ . With  $r = i$ , the equations reduce to the single equation  $\xi_1 - (2+i)\xi_2 = 0$ . A corresponding eigenvector is  $\boldsymbol{\xi}^{(1)} = (2+i, 1)^T$ . One *complex-valued* solution is

$$\mathbf{x}^{(1)} = \begin{pmatrix} 2+i \\ 1 \end{pmatrix} t^i.$$

We can write  $t^i = e^{i \ln t}$ . Hence

$$\begin{aligned} \mathbf{x}^{(1)} &= \begin{pmatrix} 2+i \\ 1 \end{pmatrix} e^{i \ln t} \\ &= \begin{pmatrix} 2+i \\ 1 \end{pmatrix} [\cos(\ln t) + i \sin(\ln t)] \\ &= \begin{pmatrix} 2 \cos(\ln t) - \sin(\ln t) \\ \cos(\ln t) \end{pmatrix} + i \begin{pmatrix} \cos(\ln t) + 2 \sin(\ln t) \\ \sin(\ln t) \end{pmatrix}. \end{aligned}$$

Therefore the general solution is

$$\mathbf{x} = c_1 \begin{pmatrix} 2 \cos(\ln t) - \sin(\ln t) \\ \cos(\ln t) \end{pmatrix} + c_2 \begin{pmatrix} \cos(\ln t) + 2 \sin(\ln t) \\ \sin(\ln t) \end{pmatrix}.$$

Other combinations are also possible.

24(a). The characteristic equation of the system is

$$r^3 + \frac{2}{5}r^2 + \frac{81}{80}r - \frac{17}{160} = 0,$$

with eigenvalues  $r_1 = 1/10$ , and  $r_{2,3} = -1/4 \pm i$ . For  $r = 1/10$ , simple calculations reveal that a corresponding eigenvector is  $\boldsymbol{\xi}^{(1)} = (0, 0, 1)^T$ . Setting  $r = -1/4 - i$ , we obtain the system of equations

$$\begin{aligned} \xi_1 - i \xi_2 &= 0 \\ \xi_3 &= 0. \end{aligned}$$

A corresponding eigenvector is  $\boldsymbol{\xi}^{(2)} = (i, 1, 0)^T$ . Hence one solution is

$$\mathbf{x}^{(1)} = \begin{pmatrix} 0 \\ 0 \\ 1 \end{pmatrix} e^{t/10}.$$

Another solution, which is *complex-valued*, is given by

$$\begin{aligned}
 \mathbf{x}^{(2)} &= \begin{pmatrix} i \\ 1 \\ 0 \end{pmatrix} e^{-(\frac{1}{4}+i)t} \\
 &= \begin{pmatrix} i \\ 1 \\ 0 \end{pmatrix} e^{-t/4} (\cos t - i \sin t) \\
 &= e^{-t/4} \begin{pmatrix} \sin t \\ \cos t \\ 0 \end{pmatrix} + i e^{-t/4} \begin{pmatrix} \cos t \\ -\sin t \\ 0 \end{pmatrix}.
 \end{aligned}$$

Using the real and imaginary parts of  $\mathbf{x}^{(2)}$ , the general solution is constructed as

$$\mathbf{x} = c_1 \begin{pmatrix} 0 \\ 0 \\ 1 \end{pmatrix} e^{t/10} + c_2 e^{-t/4} \begin{pmatrix} \sin t \\ \cos t \\ 0 \end{pmatrix} + c_3 e^{-t/4} \begin{pmatrix} \cos t \\ -\sin t \\ 0 \end{pmatrix}.$$

(b). Let  $\mathbf{x}(0) = (x_1^0, x_2^0, x_3^0)$ . The solution can be written as

$$\mathbf{x} = \begin{pmatrix} 0 \\ 0 \\ x_3^0 e^{t/10} \end{pmatrix} + e^{-t/4} \begin{pmatrix} x_2^0 \sin t + x_1^0 \cos t \\ x_2^0 \cos t - x_1^0 \sin t \\ 0 \end{pmatrix}.$$

With  $\mathbf{x}(0) = (1, 1, 1)$ , the solution of the initial value problem is

$$\mathbf{x} = \begin{pmatrix} 0 \\ 0 \\ e^{t/10} \end{pmatrix} + e^{-t/4} \begin{pmatrix} \sin t + \cos t \\ \cos t - \sin t \\ 0 \end{pmatrix}.$$

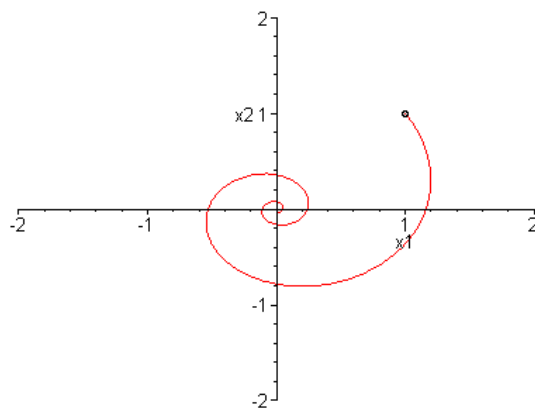

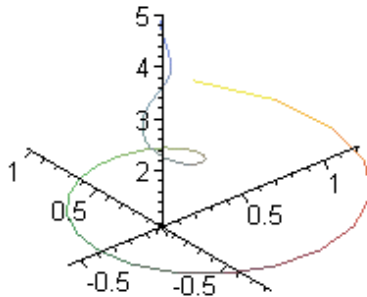
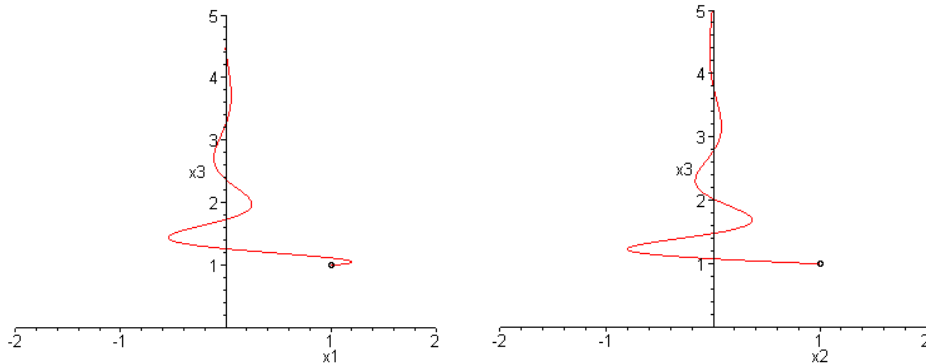

25(a). Based on Probs. 18 – 20 of Section 7.1, the system of differential equations is

$$\frac{d}{dt} \begin{pmatrix} I \\ V \end{pmatrix} = \begin{pmatrix} -\frac{R_1}{L} & -\frac{1}{L} \\ \frac{1}{C} & -\frac{1}{CR_2} \end{pmatrix} \begin{pmatrix} I \\ V \end{pmatrix}.$$

With  $R_1 = R_2 = 4 \text{ ohms}$ ,  $C = \frac{1}{2} \text{ farads}$  and  $L = 8 \text{ henrys}$ , the eigenvalue problem is

$$\begin{pmatrix} -\frac{1}{2} - r & -\frac{1}{8} \\ 2 & -\frac{1}{2} - r \end{pmatrix} \begin{pmatrix} \xi_1 \\ \xi_2 \end{pmatrix} = \begin{pmatrix} 0 \\ 0 \end{pmatrix}.$$

(b). The characteristic equation of the system is  $r^2 + r + \frac{1}{2} = 0$ , with eigenvalues

$$r_{1,2} = -\frac{1}{2} \pm \frac{1}{2}i.$$

Setting  $r = -1/2 + i/2$ , the algebraic equations reduce to  $4i\xi_1 + \xi_2 = 0$ . It follows that  $\xi^{(1)} = (1, -4i)^T$ . Hence one *complex-valued* solution is

$$\begin{aligned}
\begin{pmatrix} I \\ V \end{pmatrix}^{(1)} &= \begin{pmatrix} 1 \\ -4i \end{pmatrix} e^{(-1+i)t/2} \\
&= \begin{pmatrix} 1 \\ -4i \end{pmatrix} e^{-t/2} [\cos(t/2) + i \sin(t/2)] \\
&= e^{-t/2} \begin{pmatrix} \cos(t/2) \\ 4 \sin(t/2) \end{pmatrix} + i e^{-t/2} \begin{pmatrix} \sin(t/2) \\ -4 \cos(t/2) \end{pmatrix}.
\end{aligned}$$

Therefore the general solution is

$$\begin{pmatrix} I \\ V \end{pmatrix} = c_1 e^{-t/2} \begin{pmatrix} \cos(t/2) \\ 4 \sin(t/2) \end{pmatrix} + c_2 e^{-t/2} \begin{pmatrix} \sin(t/2) \\ -4 \cos(t/2) \end{pmatrix}.$$

(c). Imposing the initial conditions, we arrive at the equations  $c_1 = 2$  and  $c_2 = -\frac{3}{4}$ , and

$$\begin{pmatrix} I \\ V \end{pmatrix} = e^{-t/2} \begin{pmatrix} 2 \cos(t/2) - \frac{3}{4} \sin(t/2) \\ 8 \sin(t/2) + 3 \cos(t/2) \end{pmatrix}.$$

(d). Since the eigenvalues have *negative* real parts, all solutions converge to the origin.

26(a). The characteristic equation of the system is

$$r^2 + \frac{1}{RC}r + \frac{1}{CL} = 0,$$

with eigenvalues

$$r_{1,2} = -\frac{1}{2RC} \pm \frac{1}{2RC} \sqrt{1 - \frac{4R^2C}{L}}.$$

The eigenvalues are real and different provided that

$$1 - \frac{4R^2C}{L} > 0.$$

The eigenvalues are complex conjugates as long as

$$1 - \frac{4R^2C}{L} < 0.$$

(b). With the specified values, the eigenvalues are  $r_{1,2} = -1 \pm i$ . The eigenvector corresponding to  $r = -1 + i$  is  $\xi^{(1)} = (1, -4i)^T$ . Hence one *complex-valued* solution is

$$\begin{aligned}
 \begin{pmatrix} I \\ V \end{pmatrix}^{(1)} &= \begin{pmatrix} 1 \\ -1+i \end{pmatrix} e^{(-1+i)t} \\
 &= \begin{pmatrix} 1 \\ -1+i \end{pmatrix} e^{-t} (\cos t + i \sin t) \\
 &= e^{-t} \begin{pmatrix} \cos t \\ -\cos t - \sin t \end{pmatrix} + i e^{-t} \begin{pmatrix} \sin t \\ \cos t - \sin t \end{pmatrix}.
 \end{aligned}$$

Therefore the general solution is

$$\begin{pmatrix} I \\ V \end{pmatrix} = c_1 e^{-t} \begin{pmatrix} \cos t \\ -\cos t - \sin t \end{pmatrix} + c_2 e^{-t} \begin{pmatrix} \sin t \\ \cos t - \sin t \end{pmatrix}.$$

(c). Imposing the initial conditions, we arrive at the equations

$$\begin{aligned}
 c_1 &= 2 \\
 -c_1 + c_2 &= 1,
 \end{aligned}$$

with  $c_1 = 2$  and  $c_2 = 3$ . Therefore the solution of the IVP is

$$\begin{pmatrix} I \\ V \end{pmatrix} = e^{-t} \begin{pmatrix} 2 \cos t + 3 \sin t \\ \cos t - 5 \sin t \end{pmatrix}.$$

(d). Since  $\operatorname{Re}(r_{1,2}) = -1$ , all solutions converge to the origin.

27(a). Suppose that  $c_1 \mathbf{a} + c_2 \mathbf{b} = \mathbf{0}$ . Since  $\mathbf{a}$  and  $\mathbf{b}$  are the real and imaginary parts of the vector  $\boldsymbol{\xi}^{(1)}$ , respectively,  $\mathbf{a} = (\boldsymbol{\xi}^{(1)} + \overline{\boldsymbol{\xi}^{(1)}})/2$  and  $\mathbf{b} = (\boldsymbol{\xi}^{(1)} - \overline{\boldsymbol{\xi}^{(1)}})/2i$ . Hence

$$c_1 (\boldsymbol{\xi}^{(1)} + \overline{\boldsymbol{\xi}^{(1)}}) - i c_2 (\boldsymbol{\xi}^{(1)} - \overline{\boldsymbol{\xi}^{(1)}}) = \mathbf{0},$$

which leads to

$$(c_1 - i c_2) \boldsymbol{\xi}^{(1)} + (c_1 + i c_2) \overline{\boldsymbol{\xi}^{(1)}} = \mathbf{0}.$$

Now since  $\boldsymbol{\xi}^{(1)}$  and  $\overline{\boldsymbol{\xi}^{(1)}}$  are *linearly independent*, we must have

$$\begin{aligned}
 c_1 - i c_2 &= 0 \\
 c_1 + i c_2 &= 0.
 \end{aligned}$$

It follows that  $c_1 = c_2 = 0$ .

(c). Recall that

$$\begin{aligned}
 \mathbf{u}(t) &= e^{\lambda t} (\mathbf{a} \cos \mu t - \mathbf{b} \sin \mu t) \\
 \mathbf{v}(t) &= e^{\lambda t} (\mathbf{a} \cos \mu t + \mathbf{b} \sin \mu t).
 \end{aligned}$$

Consider the equation  $c_1 \mathbf{u}(t_0) + c_2 \mathbf{v}(t_0) = \mathbf{0}$ , for some  $t_0$ . We can then write

$$c_1 e^{\lambda t_0} (\mathbf{a} \cos \mu t_0 - \mathbf{b} \sin \mu t_0) + c_2 e^{\lambda t_0} (\mathbf{a} \cos \mu t_0 + \mathbf{b} \sin \mu t_0) = \mathbf{0}. \quad (*)$$

Rearranging the terms, and dividing by the exponential,

$$(c_1 + c_2) \cos \mu t_0 \mathbf{a} + (c_2 - c_1) \sin \mu t_0 \mathbf{b} = \mathbf{0}.$$

From Part (b), since  $\mathbf{a}$  and  $\mathbf{b}$  are *linearly independent*, it follows that

$$(c_1 + c_2) \cos \mu t_0 = (c_2 - c_1) \sin \mu t_0 = 0.$$

Without loss of generality, assume that the trigonometric factors are *nonzero*. Otherwise proceed again from Equation (\*), above. We then conclude that

$$c_1 + c_2 = 0 \text{ and } c_2 - c_1 = 0,$$

which leads to  $c_1 = c_2 = 0$ . Thus  $\mathbf{u}(t_0)$  and  $\mathbf{v}(t_0)$  are linearly independent for some  $t_0$ , and hence the functions are linearly independent at every point.

28(a). Let  $x_1 = u$  and  $x_2 = u'$ . It follows that  $x_1' = x_2$  and

$$\begin{aligned} x_2' &= u'' \\ &= -\frac{k}{m} u. \end{aligned}$$

In terms of the new variables, we obtain the system of two first order ODEs

$$\begin{aligned} x_1' &= x_2 \\ x_2' &= -\frac{k}{m} x_1. \end{aligned}$$

(b). The associated eigenvalue problem is

$$\begin{pmatrix} -r & 1 \\ -k/m & -r \end{pmatrix} \begin{pmatrix} \xi_1 \\ \xi_2 \end{pmatrix} = \begin{pmatrix} 0 \\ 0 \end{pmatrix}.$$

The characteristic equation is  $r^2 + k/m = 0$ , with roots  $r_{1,2} = \pm i\sqrt{k/m}$ .

(c). Since the eigenvalues are purely imaginary, the origin is a *center*. Hence the phase curves are *ellipses*, with a *clockwise* flow. For computational purposes, let  $k = 1$  and  $m = 2$ .

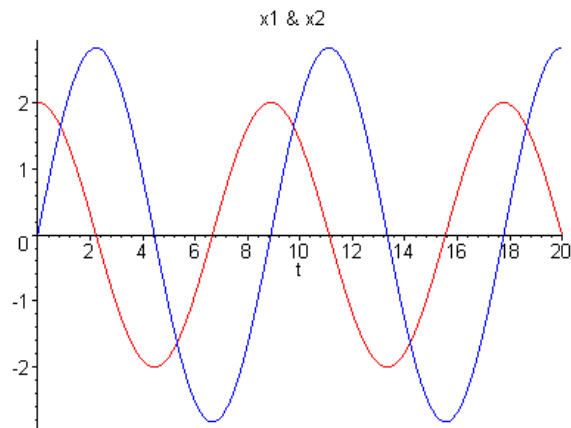
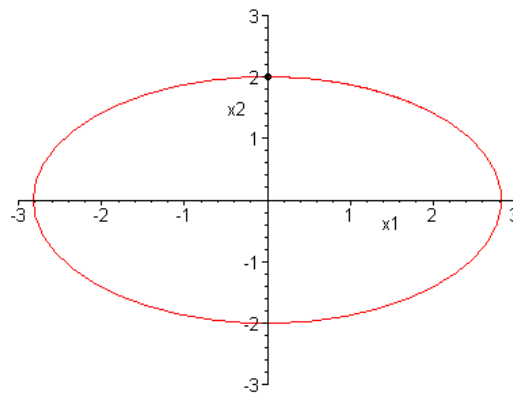
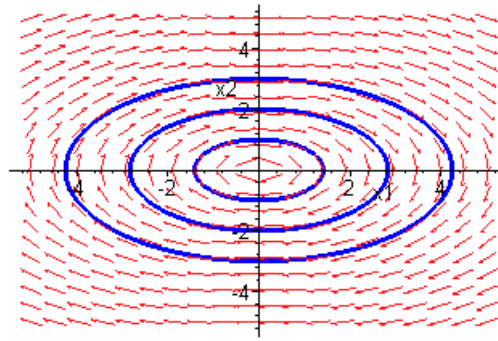

(d). The general solution of the second order equation is

$$u(t) = c_1 \cos \sqrt{\frac{k}{m}} t + c_2 \sin \sqrt{\frac{k}{m}} t.$$

The general solution of the system of ODEs is given by



$$\mathbf{x} = c_1 \begin{pmatrix} \sqrt{\frac{m}{k}} \sin \sqrt{\frac{k}{m}} t \\ \cos \sqrt{\frac{k}{m}} t \end{pmatrix} + c_2 \begin{pmatrix} \sqrt{\frac{m}{k}} \cos \sqrt{\frac{k}{m}} t \\ -\sin \sqrt{\frac{k}{m}} t \end{pmatrix}.$$

It is evident that the natural frequency of the system is equal to  $Im(r_{1,2})$ .

### Section 7.7

1. The eigenvalues and eigenvectors were found in Prob. 1, Section 7.5.

$$r_1 = -1, \quad \boldsymbol{\xi}^{(1)} = \begin{pmatrix} 1 \\ 2 \end{pmatrix}; \quad r_2 = 2, \quad \boldsymbol{\xi}^{(2)} = \begin{pmatrix} 2 \\ 1 \end{pmatrix}.$$

The general solution is

$$\mathbf{x} = c_1 \begin{pmatrix} e^{-t} \\ 2e^{-t} \end{pmatrix} + c_2 \begin{pmatrix} 2e^{2t} \\ e^{2t} \end{pmatrix}.$$

Hence a fundamental matrix is given by

$$\boldsymbol{\Psi}(t) = \begin{pmatrix} e^{-t} & 2e^{2t} \\ 2e^{-t} & e^{2t} \end{pmatrix}.$$

We now have

$$\boldsymbol{\Psi}(0) = \begin{pmatrix} 1 & 2 \\ 2 & 1 \end{pmatrix} \text{ and } \boldsymbol{\Psi}^{-1}(0) = \frac{1}{3} \begin{pmatrix} -1 & 2 \\ 2 & -1 \end{pmatrix},$$

So that

$$\boldsymbol{\Phi}(t) = \boldsymbol{\Psi}(t)\boldsymbol{\Psi}^{-1}(0) = \frac{1}{3} \begin{pmatrix} -e^{-t} + 4e^{2t} & 2e^{-t} - 2e^{2t} \\ -2e^{-t} + 2e^{2t} & 4e^{-t} - e^{2t} \end{pmatrix}.$$

3. The eigenvalues and eigenvectors were found in Prob. 3, Section 7.5. The general solution of the system is

$$\mathbf{x} = c_1 \begin{pmatrix} e^t \\ e^t \end{pmatrix} + c_2 \begin{pmatrix} e^{-t} \\ 3e^{-t} \end{pmatrix}.$$

Given the initial conditions  $\mathbf{x}(0) = \mathbf{e}^{(1)}$ , we solve the equations

$$\begin{aligned} c_1 + c_2 &= 1 \\ c_1 + 3c_2 &= 0, \end{aligned}$$

to obtain  $c_1 = 3/2, c_2 = -1/2$ . The corresponding solution is

$$\mathbf{x} = \begin{pmatrix} \frac{3}{2}e^t - \frac{1}{2}e^{-t} \\ \frac{3}{2}e^t - \frac{3}{2}e^{-t} \end{pmatrix}.$$

Given the initial conditions  $\mathbf{x}(0) = \mathbf{e}^{(2)}$ , we solve the equations

$$\begin{aligned} c_1 + c_2 &= 0 \\ c_1 + 3c_2 &= 1, \end{aligned}$$

to obtain  $c_1 = -1/2, c_2 = 1/2$ . The corresponding solution is

$$\mathbf{x} = \begin{pmatrix} -\frac{1}{2}e^t + \frac{1}{2}e^{-t} \\ -\frac{1}{2}e^t + \frac{3}{2}e^{-t} \end{pmatrix}.$$

Therefore the fundamental matrix is

$$\Phi(t) = \frac{1}{2} \begin{pmatrix} 3e^t - e^{-t} & -e^t + e^{-t} \\ 3e^t - 3e^{-t} & -e^t + 3e^{-t} \end{pmatrix}.$$

5. The general solution, found in Prob. 3, Section 7.6, is given by

$$\mathbf{x} = c_1 \begin{pmatrix} 5 \cos t \\ 2 \cos t + \sin t \end{pmatrix} + c_2 \begin{pmatrix} 5 \sin t \\ -\cos t + 2 \sin t \end{pmatrix}.$$

Given the initial conditions  $\mathbf{x}(0) = \mathbf{e}^{(1)}$ , we solve the equations

$$\begin{aligned} 5c_1 &= 1 \\ 2c_1 - c_2 &= 0, \end{aligned}$$

resulting in  $c_1 = 1/5$ ,  $c_2 = 2/5$ . The corresponding solution is

$$\mathbf{x} = \begin{pmatrix} \cos t + 2 \sin t \\ \sin t \end{pmatrix}.$$

Given the initial conditions  $\mathbf{x}(0) = \mathbf{e}^{(2)}$ , we solve the equations

$$\begin{aligned} 5c_1 &= 0 \\ 2c_1 - c_2 &= 1, \end{aligned}$$

resulting in  $c_1 = 0$ ,  $c_2 = -1$ . The corresponding solution is

$$\mathbf{x} = \begin{pmatrix} -5 \sin t \\ \cos t - 2 \sin t \end{pmatrix}.$$

Therefore the fundamental matrix is

$$\Phi(t) = \begin{pmatrix} \cos t + 2 \sin t & -5 \sin t \\ \sin t & \cos t - 2 \sin t \end{pmatrix}.$$

7. The general solution, found in Prob. 15, Section 7.5, is given by

$$\mathbf{x} = c_1 \begin{pmatrix} e^{2t} \\ 3e^{2t} \end{pmatrix} + c_2 \begin{pmatrix} e^{4t} \\ e^{4t} \end{pmatrix}.$$

Given the initial conditions  $\mathbf{x}(0) = \mathbf{e}^{(1)}$ , we solve the equations

$$\begin{aligned} c_1 + c_2 &= 1 \\ 3c_1 + c_2 &= 0, \end{aligned}$$

resulting in  $c_1 = -1/2$ ,  $c_2 = 3/2$ . The corresponding solution is

$$\mathbf{x} = \frac{1}{2} \begin{pmatrix} -e^{2t} + 3e^{4t} \\ -3e^{2t} + 3e^{4t} \end{pmatrix}.$$

The initial conditions  $\mathbf{x}(0) = \mathbf{e}^{(2)}$  require that

$$\begin{aligned} c_1 + c_2 &= 0 \\ 3c_1 + c_2 &= 1, \end{aligned}$$

resulting in  $c_1 = 1/2$ ,  $c_2 = -1/2$ . The corresponding solution is

$$\mathbf{x} = \frac{1}{2} \begin{pmatrix} e^{2t} - e^{4t} \\ 3e^{2t} - e^{4t} \end{pmatrix}.$$

Therefore the fundamental matrix is

$$\Phi(t) = \frac{1}{2} \begin{pmatrix} -e^{2t} + 3e^{4t} & e^{2t} - e^{4t} \\ -3e^{2t} + 3e^{4t} & 3e^{2t} - e^{4t} \end{pmatrix}.$$

8. The general solution, found in Prob. 5, Section 7.6, is given by

$$\mathbf{x} = c_1 e^{-t} \begin{pmatrix} \cos t \\ 2 \cos t + \sin t \end{pmatrix} + c_2 e^{-t} \begin{pmatrix} \sin t \\ -\cos t + 2 \sin t \end{pmatrix}.$$

The specific solution corresponding to the initial conditions  $\mathbf{x}(0) = \mathbf{e}^{(1)}$  is

$$\mathbf{x} = e^{-t} \begin{pmatrix} \cos t + 2 \sin t \\ 5 \sin t \end{pmatrix}.$$

For the initial conditions  $\mathbf{x}(0) = \mathbf{e}^{(2)}$ , the solution is

$$\mathbf{x} = e^{-t} \begin{pmatrix} -\sin t \\ \cos t - 2 \sin t \end{pmatrix}.$$

Therefore the fundamental matrix is

$$\Phi(t) = e^{-t} \begin{pmatrix} \cos t + 2 \sin t & -\sin t \\ 5 \sin t & \cos t - 2 \sin t \end{pmatrix}.$$

9. The general solution, found in Prob. 13, Section 7.5, is given by

$$\mathbf{x} = c_1 \begin{pmatrix} 4e^{-2t} \\ -5e^{-2t} \\ -7e^{-2t} \end{pmatrix} + c_2 \begin{pmatrix} 3e^{-t} \\ -4e^{-t} \\ -2e^{-t} \end{pmatrix} + c_3 \begin{pmatrix} 0 \\ e^{2t} \\ -e^{2t} \end{pmatrix}.$$

Given the initial conditions  $\mathbf{x}(0) = \mathbf{e}^{(1)}$ , we solve the equations

$$\begin{aligned}4c_1 + 3c_2 &= 1 \\-5c_1 - 4c_2 + c_3 &= 0 \\-7c_1 - 2c_2 - c_3 &= 0,\end{aligned}$$

resulting in  $c_1 = -1/2$ ,  $c_2 = 1$ ,  $c_3 = 3/2$ . The corresponding solution is

$$\mathbf{x} = \begin{pmatrix} -2e^{-2t} + 3e^{-t} \\ \frac{5}{2}e^{-2t} - 4e^{-t} + \frac{3}{2}e^{2t} \\ \frac{7}{2}e^{-2t} - 2e^{-t} - \frac{3}{2}e^{2t} \end{pmatrix}.$$

The initial conditions  $\mathbf{x}(0) = \mathbf{e}^{(2)}$ , we solve the equations

$$\begin{aligned}4c_1 + 3c_2 &= 0 \\-5c_1 - 4c_2 + c_3 &= 1 \\-7c_1 - 2c_2 - c_3 &= 0,\end{aligned}$$

resulting in  $c_1 = -1/4$ ,  $c_2 = 1/3$ ,  $c_3 = 13/12$ . The corresponding solution is

$$\mathbf{x} = \begin{pmatrix} -e^{-2t} + e^{-t} \\ \frac{5}{4}e^{-2t} - \frac{4}{3}e^{-t} + \frac{13}{12}e^{2t} \\ \frac{7}{4}e^{-2t} - \frac{2}{3}e^{-t} - \frac{13}{12}e^{2t} \end{pmatrix}.$$

The initial conditions  $\mathbf{x}(0) = \mathbf{e}^{(3)}$ , we solve the equations

$$\begin{aligned}4c_1 + 3c_2 &= 0 \\-5c_1 - 4c_2 + c_3 &= 0 \\-7c_1 - 2c_2 - c_3 &= 1,\end{aligned}$$

resulting in  $c_1 = -1/4$ ,  $c_2 = 1/3$ ,  $c_3 = 1/12$ . The corresponding solution is

$$\mathbf{x} = \begin{pmatrix} -e^{-2t} + e^{-t} \\ \frac{5}{4}e^{-2t} - \frac{4}{3}e^{-t} + \frac{1}{12}e^{2t} \\ \frac{7}{4}e^{-2t} - \frac{2}{3}e^{-t} - \frac{1}{12}e^{2t} \end{pmatrix}.$$

Therefore the fundamental matrix is

$$\Phi(t) = \begin{pmatrix} -2e^{-2t} + 3e^{-t} & -e^{-2t} + e^{-t} & -e^{-2t} + e^{-t} \\ \frac{5}{2}e^{-2t} - 4e^{-t} + \frac{3}{2}e^{2t} & \frac{5}{4}e^{-2t} - \frac{4}{3}e^{-t} + \frac{13}{12}e^{2t} & \frac{5}{4}e^{-2t} - \frac{4}{3}e^{-t} + \frac{1}{12}e^{2t} \\ \frac{7}{2}e^{-2t} - 2e^{-t} - \frac{3}{2}e^{2t} & \frac{7}{4}e^{-2t} - \frac{2}{3}e^{-t} - \frac{13}{12}e^{2t} & \frac{7}{4}e^{-2t} - \frac{2}{3}e^{-t} - \frac{1}{12}e^{2t} \end{pmatrix}.$$

12. The solution of the initial value problem is given by

$$\begin{aligned}
 \mathbf{x} &= \Phi(t)\mathbf{x}(0) \\
 &= \begin{pmatrix} e^{-t}\cos 2t & -2e^{-t}\sin 2t \\ \frac{1}{2}e^{-t}\sin 2t & e^{-t}\cos 2t \end{pmatrix} \begin{pmatrix} 3 \\ 1 \end{pmatrix} \\
 &= e^{-t} \begin{pmatrix} 3\cos 2t - 2\sin 2t \\ \frac{3}{2}\sin 2t + \cos 2t \end{pmatrix}.
 \end{aligned}$$

13. Let

$$\Psi(t) = \begin{pmatrix} x_1^{(1)}(t) & \cdots & x_1^{(n)}(t) \\ \vdots & & \vdots \\ x_n^{(1)}(t) & \cdots & x_n^{(n)}(t) \end{pmatrix}.$$

It follows that

$$\Psi(t_0) = \begin{pmatrix} x_1^{(1)}(t_0) & \cdots & x_1^{(n)}(t_0) \\ \vdots & & \vdots \\ x_n^{(1)}(t_0) & \cdots & x_n^{(n)}(t_0) \end{pmatrix}$$

is a *scalar* matrix, which is invertible, since the solutions are linearly independent.

Let  $\Psi^{-1}(t_0) = (c_{ij})$ . Then

$$\Psi(t)\Psi^{-1}(t_0) = \begin{pmatrix} x_1^{(1)}(t) & \cdots & x_1^{(n)}(t) \\ \vdots & & \vdots \\ x_n^{(1)}(t) & \cdots & x_n^{(n)}(t) \end{pmatrix} \begin{pmatrix} c_{11} & \cdots & c_{1n} \\ \vdots & & \vdots \\ c_{n1} & \cdots & c_{nn} \end{pmatrix}.$$

The  $j$ -th column of the product matrix is

$$[\Psi(t)\Psi^{-1}(t_0)]^{(j)} = \sum_{k=1}^n c_{kj} \mathbf{x}^{(k)},$$

which is a solution vector, since it is a linear combination of solutions. Furthermore, the columns are all linearly independent, since the vectors  $\mathbf{x}^{(k)}$  are. Hence the product is a fundamental matrix. Finally, setting  $t = t_0$ ,  $\Psi(t_0)\Psi^{-1}(t_0) = \mathbf{I}$ . This is precisely the definition of  $\Phi(t)$ .

14. The fundamental matrix  $\Phi(t)$  for the system

$$\mathbf{x}' = \begin{pmatrix} 1 & 1 \\ 4 & 1 \end{pmatrix} \mathbf{x}$$

is given by

$$\Phi(t) = \frac{1}{4} \begin{pmatrix} 2e^{3t} + 2e^{-t} & e^{3t} - e^{-t} \\ 4e^{3t} - 4e^{-t} & 2e^{3t} + 2e^{-t} \end{pmatrix}.$$

Direct multiplication results in

$$\begin{aligned}\Phi(t)\Phi(s) &= \frac{1}{16} \begin{pmatrix} 2e^{3t} + 2e^{-t} & e^{3t} - e^{-t} \\ 4e^{3t} - 4e^{-t} & 2e^{3t} + 2e^{-t} \end{pmatrix} \begin{pmatrix} 2e^{3s} + 2e^{-s} & e^{3s} - e^{-s} \\ 4e^{3s} - 4e^{-s} & 2e^{3s} + 2e^{-s} \end{pmatrix} \\ &= \frac{1}{16} \begin{pmatrix} 8(e^{3t+3s} + e^{-t-s}) & 4(e^{3t+3s} - e^{-t-s}) \\ 16(e^{3t+3s} - e^{-t-s}) & 8(e^{3t+3s} + e^{-t-s}) \end{pmatrix}.\end{aligned}$$

Hence

$$\Phi(t)\Phi(s) = \frac{1}{4} \begin{pmatrix} 2e^{3(t+s)} + 2e^{-(t+s)} & e^{3(t+s)} - e^{-(t+s)} \\ 4e^{3(t+s)} - 4e^{-(t+s)} & 2e^{3(t+s)} + 2e^{-(t+s)} \end{pmatrix}.$$

15(a). Let  $s$  be arbitrary, but *fixed*, and  $t$  variable. Similar to the argument in Prob. 13, the *columns* of the matrix  $\Phi(t)\Phi(s)$  are linear combinations of fundamental solutions. Hence the columns of  $\Phi(t)\Phi(s)$  are also solution of the system of equations. Further, setting  $t = 0$ ,  $\Phi(0)\Phi(s) = \mathbf{I}\Phi(s) = \Phi(s)$ . That is,  $\Phi(t)\Phi(s)$  is a solution of the initial value problem  $\mathbf{Z}' = \mathbf{A}\mathbf{Z}$ , with  $\mathbf{Z}(0) = \Phi(s)$ . Now consider the change of variable  $\tau = t + s$ . Let  $\mathbf{W}(\tau) = \mathbf{Z}(\tau - s)$ . The given initial value problem can be reformulated as

$$\frac{d}{d\tau}\mathbf{W} = \mathbf{A}\mathbf{W}, \text{ with } \mathbf{W}(s) = \Phi(s).$$

Since  $\Phi(t)$  is a fundamental matrix satisfying  $\Phi' = \mathbf{A}\Phi$ , with  $\Phi(0) = \mathbf{I}$ , it follows that

$$\begin{aligned}\mathbf{W}(\tau) &= [\Phi(\tau)\Phi^{-1}(s)]\Phi(s) \\ &= \Phi(\tau).\end{aligned}$$

That is,  $\Phi(t + s) = \Phi(\tau) = \mathbf{W}(\tau) = \mathbf{Z}(t) = \Phi(t)\Phi(s)$ .

(b). Based on Part (a),  $\Phi(t)\Phi(-t) = \Phi(t + (-t)) = \Phi(0) = \mathbf{I}$ . Hence

$$\Phi(-t) = \Phi^{-1}(t).$$

(c). It also follows that  $\Phi(t - s) = \Phi(t + (-s)) = \Phi(t)\Phi(-s) = \Phi(t)\Phi^{-1}(s)$ .

16. Let  $\mathbf{A}$  be a *diagonal matrix*, with  $\mathbf{A} = [a_1\mathbf{e}^{(1)}, a_2\mathbf{e}^{(2)}, \dots, a_n\mathbf{e}^{(n)}]$ . Note that for any positive integer,  $k$ ,

$$\mathbf{A}^k = [a_1^k\mathbf{e}^{(1)}, a_2^k\mathbf{e}^{(2)}, \dots, a_n^k\mathbf{e}^{(n)}].$$

It follows, from basic matrix algebra, that

$$\mathbf{I} + \sum_{k=1}^m \mathbf{A}^k \frac{t^k}{k!} = \begin{pmatrix} \sum_{k=0}^m a_1^k \frac{t^k}{k!} & 0 & \cdots & 0 \\ 0 & \sum_{k=0}^m a_2^k \frac{t^k}{k!} & \cdots & 0 \\ \vdots & \vdots & \ddots & \vdots \\ 0 & 0 & \cdots & \sum_{k=0}^m a_n^k \frac{t^k}{k!} \end{pmatrix}.$$

It can be shown that the partial sums on the left hand side converge for all  $t$ . Taking the limit (as  $m \rightarrow \infty$ ) on both sides of the equation, we obtain

$$\exp(\mathbf{A}t) = \begin{pmatrix} e^{a_1 t} & 0 & \cdots & 0 \\ 0 & e^{a_2 t} & \cdots & 0 \\ \vdots & \vdots & \ddots & \vdots \\ 0 & 0 & \cdots & e^{a_n t} \end{pmatrix}.$$

Alternatively, consider the system  $\mathbf{x}' = \mathbf{A}\mathbf{x}$ . Since ODEs are *uncoupled*, the vectors  $\mathbf{x}^{(j)} = \exp(a_j t) \mathbf{e}^{(j)}$ ,  $j = 1, 2, \dots, n$ , are a set of linearly independent solutions. Hence the matrix

$$\mathbf{X} = [\exp(a_1 t) \mathbf{e}^{(1)}, \exp(a_2 t) \mathbf{e}^{(2)}, \dots, \exp(a_n t) \mathbf{e}^{(n)}]$$

is a *fundamental matrix*. Finally, since  $\mathbf{X}(0) = \mathbf{I}$ , it follows that

$$[\exp(a_1 t) \mathbf{e}^{(1)}, \exp(a_2 t) \mathbf{e}^{(2)}, \dots, \exp(a_n t) \mathbf{e}^{(n)}] = \mathbf{\Phi}(t) = \exp(\mathbf{A}t).$$

17(a). Assuming that  $\mathbf{x} = \phi(t)$  is a solution, then  $\phi' = \mathbf{A}\phi$ , with  $\phi(0) = \mathbf{x}^0$ . Integrate both sides of the equation to obtain

$$\phi(t) - \phi(0) = \int_0^t \mathbf{A}\phi(s) ds.$$

Hence

$$\phi(t) = \mathbf{x}^0 + \int_0^t \mathbf{A}\phi(s) ds.$$

(b). Proceed with the iteration

$$\phi^{(i+1)}(t) = \mathbf{x}^0 + \int_0^t \mathbf{A}\phi^{(i)}(s) ds.$$

With  $\phi^{(0)}(t) = \mathbf{x}^0$ , and noting that  $\mathbf{A}$  is a *constant* matrix,



$$\begin{aligned}\phi^{(1)}(t) &= \mathbf{x}^0 + \int_0^t \mathbf{A}\mathbf{x}^0 ds \\ &= \mathbf{x}^0 + \mathbf{A}\mathbf{x}^0 t.\end{aligned}$$

That is,  $\phi^{(1)}(t) = (\mathbf{I} + \mathbf{A}t)\mathbf{x}^0$ .

(c). We then have

$$\begin{aligned}\phi^{(2)}(t) &= \mathbf{x}^0 + \int_0^t \mathbf{A}(\mathbf{I} + \mathbf{A}s)\mathbf{x}^0 ds \\ &= \mathbf{x}^0 + \mathbf{A}\mathbf{x}^0 t + \mathbf{A}^2 \mathbf{x}^0 \frac{t^2}{2} \\ &= \left( \mathbf{I} + \mathbf{A}t + \mathbf{A}^2 \frac{t^2}{2} \right) \mathbf{x}^0.\end{aligned}$$

Now suppose that

$$\phi^{(n)}(t) = \left( \mathbf{I} + \mathbf{A}t + \mathbf{A}^2 \frac{t^2}{2} + \cdots + \mathbf{A}^n \frac{t^n}{n!} \right) \mathbf{x}^0.$$

It follows that

$$\begin{aligned}\int_0^t \mathbf{A} \left( \mathbf{I} + \mathbf{A}s + \mathbf{A}^2 \frac{s^2}{2} + \cdots + \mathbf{A}^n \frac{s^n}{n!} \right) \mathbf{x}^0 ds &= \\ &= \mathbf{A} \left( \mathbf{I}t + \mathbf{A} \frac{t^2}{2} + \mathbf{A}^2 \frac{t^3}{3!} + \cdots + \mathbf{A}^n \frac{t^{n+1}}{(n+1)!} \right) \mathbf{x}^0 \\ &= \left( \mathbf{A}t + \mathbf{A}^2 \frac{t^2}{2} + \mathbf{A}^3 \frac{t^3}{3!} + \cdots + \mathbf{A}^{n+1} \frac{t^n}{n!} \right) \mathbf{x}^0.\end{aligned}$$

Therefore

$$\phi^{(n+1)}(t) = \left( \mathbf{I} + \mathbf{A}t + \mathbf{A}^2 \frac{t^2}{2} + \cdots + \mathbf{A}^{n+1} \frac{t^{n+1}}{(n+1)!} \right) \mathbf{x}^0.$$

By induction, the asserted form of  $\phi^{(n)}(t)$  is valid for all  $n \geq 0$ .

(d). Define  $\phi^{(\infty)}(t) = \lim_{n \rightarrow \infty} \phi^{(n)}(t)$ . It can be shown that the limit does exist. In fact,

$$\phi^{(\infty)}(t) = \exp(\mathbf{A}t)\mathbf{x}^0.$$

Term-by-term differentiation results in

$$\begin{aligned}
\frac{d}{dt}\phi^{(\infty)}(t) &= \frac{d}{dt}\left(\mathbf{I} + \mathbf{A}t + \mathbf{A}^2\frac{t^2}{2} + \cdots + \mathbf{A}^n\frac{t^n}{n!} + \cdots\right)\mathbf{x}^0 \\
&= \left(\mathbf{A} + \mathbf{A}^2t + \cdots + \mathbf{A}^n\frac{t^{n-1}}{(n-1)!} + \cdots\right)\mathbf{x}^0 \\
&= \mathbf{A}\left(\mathbf{I} + \mathbf{A}t + \mathbf{A}^2\frac{t^2}{2} + \cdots + \mathbf{A}^{n-1}\frac{t^{n-1}}{(n-1)!} + \cdots\right)\mathbf{x}^0.
\end{aligned}$$

That is,

$$\frac{d}{dt}\phi^{(\infty)}(t) = \mathbf{A}\phi^{(\infty)}(t).$$

Furthermore,  $\phi^{(\infty)}(0) = \mathbf{x}^0$ . Based on *uniqueness* of solutions,  $\phi(t) = \phi^{(\infty)}(t)$ .

## Section 7.8

2. Setting  $\mathbf{x} = \boldsymbol{\xi} t^r$  results in the algebraic equations

$$\begin{pmatrix} 4-r & -2 \\ 8 & -4-r \end{pmatrix} \begin{pmatrix} \xi_1 \\ \xi_2 \end{pmatrix} = \begin{pmatrix} 0 \\ 0 \end{pmatrix}.$$

The characteristic equation is  $r^2 = 0$ , with the *single* root  $r = 0$ . Substituting  $r = 0$  reduces the system of equations to  $2\xi_1 - \xi_2 = 0$ . Therefore the only eigenvector is  $\boldsymbol{\xi} = (1, 2)^T$ . One solution is

$$\mathbf{x}^{(1)} = \begin{pmatrix} 1 \\ 2 \end{pmatrix},$$

which is a *constant* vector. In order to generate a second linearly independent solution, we must search for a *generalized eigenvector*. This leads to the system of equations

$$\begin{pmatrix} 4 & -2 \\ 8 & -4 \end{pmatrix} \begin{pmatrix} \eta_1 \\ \eta_2 \end{pmatrix} = \begin{pmatrix} 1 \\ 2 \end{pmatrix}.$$

This system also reduces to a single equation,  $2\eta_1 - \eta_2 = 1/2$ . Setting  $\eta_1 = k$ , some arbitrary constant, we obtain  $\eta_2 = 2k - 1/2$ . A second solution is

$$\begin{aligned} \mathbf{x}^{(2)} &= \begin{pmatrix} 1 \\ 2 \end{pmatrix} t + \begin{pmatrix} k \\ 2k - 1/2 \end{pmatrix} \\ &= \begin{pmatrix} 1 \\ 2 \end{pmatrix} t + \begin{pmatrix} 0 \\ -1/2 \end{pmatrix} + k \begin{pmatrix} 1 \\ 2 \end{pmatrix}. \end{aligned}$$

Note that the *last* term is a multiple of  $\mathbf{x}^{(1)}$  and may be dropped. Hence

$$\mathbf{x}^{(2)} = \begin{pmatrix} 1 \\ 2 \end{pmatrix} t + \begin{pmatrix} 0 \\ -1/2 \end{pmatrix}.$$

The general solution is

$$\mathbf{x} = c_1 \begin{pmatrix} 1 \\ 2 \end{pmatrix} + c_2 \left[ \begin{pmatrix} 1 \\ 2 \end{pmatrix} t + \begin{pmatrix} 0 \\ -1/2 \end{pmatrix} \right].$$

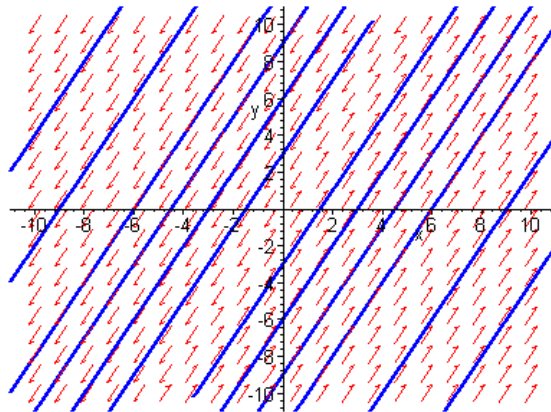

All of the points on the line  $x_2 = 2x_1$  are equilibrium points. Solutions starting at all other points become unbounded.

3. Solution of the ODEs is based on the analysis of the algebraic equations

$$\begin{pmatrix} -\frac{3}{2} - r & 1 \\ -\frac{1}{4} & -\frac{1}{2} - r \end{pmatrix} \begin{pmatrix} \xi_1 \\ \xi_2 \end{pmatrix} = \begin{pmatrix} 0 \\ 0 \end{pmatrix}.$$

The characteristic equation is  $r^2 + 2r + 1 = 0$ , with a single root  $r = -1$ . Setting  $r = -1$ , the two equations reduce to  $\xi_1 - 2\xi_2 = 0$ . The corresponding eigenvector is  $\xi = (2, 1)^T$ . One solution is

$$\mathbf{x}^{(1)} = \begin{pmatrix} 2 \\ 1 \end{pmatrix} e^{-t}.$$

A second linearly independent solution is obtained by finding a *generalized eigenvector*. We therefore analyze the system

$$\begin{pmatrix} -\frac{1}{2} & 1 \\ -\frac{1}{4} & \frac{1}{2} \end{pmatrix} \begin{pmatrix} \eta_1 \\ \eta_2 \end{pmatrix} = \begin{pmatrix} 1 \\ 2 \end{pmatrix}.$$

The equations reduce to the single equation  $-\eta_1 + 2\eta_2 = 2$ . Let  $\eta_1 = 2k$ . We obtain  $\eta_2 = 1 + k$ , and a second linearly independent solution is

$$\begin{aligned} \mathbf{x}^{(2)} &= \begin{pmatrix} 2 \\ 1 \end{pmatrix} t e^{-t} + \begin{pmatrix} 2k \\ 1+k \end{pmatrix} e^{-t} \\ &= \begin{pmatrix} 2 \\ 1 \end{pmatrix} t e^{-t} + \begin{pmatrix} 0 \\ 1 \end{pmatrix} e^{-t} + k \begin{pmatrix} 2 \\ 1 \end{pmatrix} e^{-t}. \end{aligned}$$

Dropping the last term, the general solution is

$$\mathbf{x} = c_1 \begin{pmatrix} 2 \\ 1 \end{pmatrix} e^{-t} + c_2 \left[ \begin{pmatrix} 2 \\ 1 \end{pmatrix} t e^{-t} + \begin{pmatrix} 0 \\ 1 \end{pmatrix} e^{-t} \right].$$

4. Solution of the ODE requires analysis of the algebraic equations

$$\begin{pmatrix} -3-r & \frac{5}{2} \\ -\frac{5}{2} & 2-r \end{pmatrix} \begin{pmatrix} \xi_1 \\ \xi_2 \end{pmatrix} = \begin{pmatrix} 0 \\ 0 \end{pmatrix}.$$

For a nonzero solution, we must have  $\det(\mathbf{A} - r\mathbf{I}) = r^2 + r + \frac{1}{4} = 0$ . The only root is  $r = -1/2$ , which is an eigenvalue of multiplicity *two*. Setting  $r = -1/2$  is the coefficient matrix reduces the system to the single equation  $-\xi_1 + \xi_2 = 0$ . Hence the corresponding eigenvector is  $\boldsymbol{\xi} = (1, 1)^T$ . One solution is

$$\mathbf{x}^{(1)} = \begin{pmatrix} 1 \\ 1 \end{pmatrix} e^{-t/2}.$$

In order to obtain a second linearly independent solution, we find a solution of the system

$$\begin{pmatrix} -\frac{5}{2} & \frac{5}{2} \\ -\frac{5}{2} & \frac{5}{2} \end{pmatrix} \begin{pmatrix} \eta_1 \\ \eta_2 \end{pmatrix} = \begin{pmatrix} 1 \\ 1 \end{pmatrix}.$$

These equations reduce to  $-5\eta_1 + 5\eta_2 = 2$ . Set  $\eta_1 = k$ , some arbitrary constant. Then  $\eta_2 = k + 2/5$ . A second solution is

$$\begin{aligned} \mathbf{x}^{(2)} &= \begin{pmatrix} 1 \\ 1 \end{pmatrix} t e^{-t/2} + \begin{pmatrix} k \\ k + 2/5 \end{pmatrix} e^{-t/2} \\ &= \begin{pmatrix} 1 \\ 1 \end{pmatrix} t e^{-t/2} + \begin{pmatrix} 0 \\ 2/5 \end{pmatrix} e^{-t/2} + k \begin{pmatrix} 1 \\ 1 \end{pmatrix} e^{-t/2}. \end{aligned}$$

Dropping the *last* term, the general solution is

$$\mathbf{x} = c_1 \begin{pmatrix} 1 \\ 1 \end{pmatrix} e^{-t/2} + c_2 \left[ \begin{pmatrix} 1 \\ 1 \end{pmatrix} t e^{-t/2} + \begin{pmatrix} 0 \\ 2/5 \end{pmatrix} e^{-t/2} \right].$$

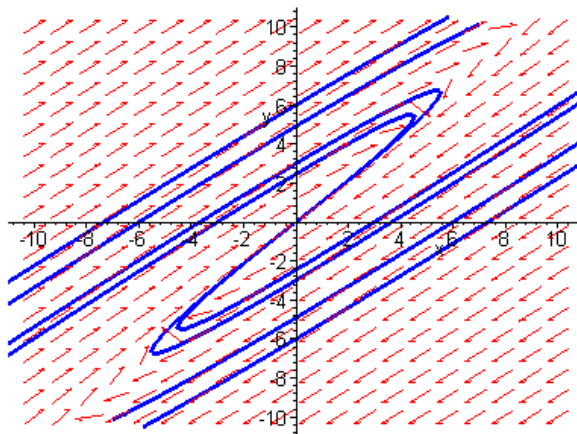

6. The eigensystem is obtained from analysis of the equation

$$\begin{pmatrix} -r & 1 & 1 \\ 1 & -r & 1 \\ 1 & 1 & -r \end{pmatrix} \begin{pmatrix} \xi_1 \\ \xi_2 \\ \xi_3 \end{pmatrix} = \begin{pmatrix} 0 \\ 0 \\ 0 \end{pmatrix}.$$

The characteristic equation of the coefficient matrix is  $r^3 - 3r - 2 = 0$ , with roots  $r_1 = 2$  and  $r_{2,3} = -1$ . Setting  $r = 2$ , we have

$$\begin{pmatrix} -2 & 1 & 1 \\ 1 & -2 & 1 \\ 1 & 1 & -2 \end{pmatrix} \begin{pmatrix} \xi_1 \\ \xi_2 \\ \xi_3 \end{pmatrix} = \begin{pmatrix} 0 \\ 0 \\ 0 \end{pmatrix}.$$

This system is reduced to the equations

$$\begin{aligned} \xi_1 - \xi_3 &= 0 \\ \xi_2 - \xi_3 &= 0. \end{aligned}$$

A corresponding eigenvector vector is given by  $\boldsymbol{\xi}^{(1)} = (1, 1, 1)^T$ . Setting  $r = -1$ , the system of equations is reduced to the *single* equation

$$\xi_1 + \xi_2 + \xi_3 = 0.$$

An eigenvector vector is given by  $\boldsymbol{\xi}^{(2)} = (1, 0, -1)^T$ . Since the last equation has two free variables, a third linearly independent eigenvector (associated with  $r = -1$ ) is  $\boldsymbol{\xi}^{(3)} = (0, 1, -1)^T$ . Therefore the general solution may be written as

$$\mathbf{x} = c_1 \begin{pmatrix} 1 \\ 1 \\ 1 \end{pmatrix} e^{2t} + c_2 \begin{pmatrix} 1 \\ 0 \\ -1 \end{pmatrix} e^{-t} + c_3 \begin{pmatrix} 0 \\ 1 \\ -1 \end{pmatrix} e^{-t}.$$

7. Solution of the ODE requires analysis of the algebraic equations

$$\begin{pmatrix} 1-r & -4 \\ 4 & -7-r \end{pmatrix} \begin{pmatrix} \xi_1 \\ \xi_2 \end{pmatrix} = \begin{pmatrix} 0 \\ 0 \end{pmatrix}.$$

For a nonzero solution, we must have  $\det(\mathbf{A} - r\mathbf{I}) = r^2 + 6r + 9 = 0$ . The only root is  $r = -3$ , which is an eigenvalue of multiplicity *two*. Substituting  $r = 3$  into the coefficient matrix, the system reduces to the single equation  $\xi_1 - \xi_2 = 0$ . Hence the corresponding eigenvector is  $\boldsymbol{\xi} = (1, 1)^T$ . One solution is

$$\mathbf{x}^{(1)} = \begin{pmatrix} 1 \\ 1 \end{pmatrix} e^{-3t}.$$

For a second linearly independent solution, we search for a *generalized eigenvector*. Its components satisfy

$$\begin{pmatrix} 4 & -4 \\ 4 & -4 \end{pmatrix} \begin{pmatrix} \eta_1 \\ \eta_2 \end{pmatrix} = \begin{pmatrix} 1 \\ 1 \end{pmatrix},$$

that is,  $4\eta_1 - 4\eta_2 = 1$ . Let  $\eta_2 = k$ , some arbitrary constant. Then  $\eta_1 = k + 1/4$ . It follows that a second solution is given by

$$\begin{aligned} \mathbf{x}^{(2)} &= \begin{pmatrix} 1 \\ 1 \end{pmatrix} t e^{-3t} + \begin{pmatrix} k + 1/4 \\ k \end{pmatrix} e^{-3t} \\ &= \begin{pmatrix} 1 \\ 1 \end{pmatrix} t e^{-3t} + \begin{pmatrix} 1/4 \\ 0 \end{pmatrix} e^{-3t} + k \begin{pmatrix} 1 \\ 1 \end{pmatrix} e^{-3t}. \end{aligned}$$

Dropping the last term, the general solution is

$$\mathbf{x} = c_1 \begin{pmatrix} 1 \\ 1 \end{pmatrix} e^{-3t} + c_2 \left[ \begin{pmatrix} 1 \\ 1 \end{pmatrix} t e^{-3t} + \begin{pmatrix} 1/4 \\ 0 \end{pmatrix} e^{-3t} \right].$$

Imposing the initial conditions, we require that

$$\begin{aligned} c_1 + \frac{1}{4}c_2 &= 3 \\ c_1 &= 2, \end{aligned}$$

which results in  $c_1 = 2$  and  $c_2 = 4$ . Therefore the solution of the IVP is

$$\mathbf{x} = \begin{pmatrix} 3 \\ 2 \end{pmatrix} e^{-3t} + \begin{pmatrix} 4 \\ 4 \end{pmatrix} t e^{-3t}.$$

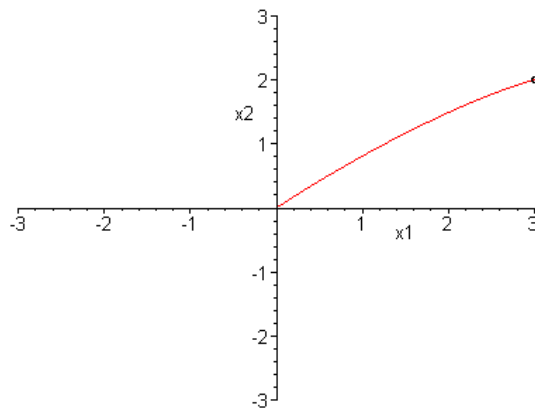

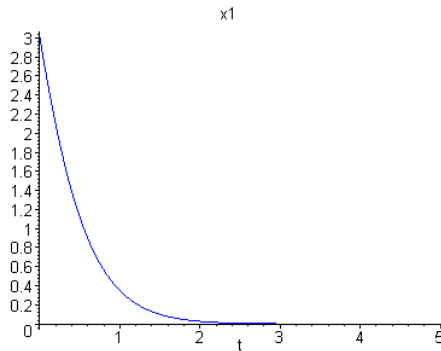

8. Solution of the ODEs is based on the analysis of the algebraic equations

$$\begin{pmatrix} -\frac{5}{2} - r & \frac{3}{2} \\ -\frac{3}{2} & \frac{1}{2} - r \end{pmatrix} \begin{pmatrix} \xi_1 \\ \xi_2 \end{pmatrix} = \begin{pmatrix} 0 \\ 0 \end{pmatrix}.$$

The characteristic equation is  $r^2 + 2r + 1 = 0$ , with a single root  $r = -1$ . Setting  $r = -1$ , the two equations reduce to  $-\xi_1 + \xi_2 = 0$ . The corresponding eigenvector is  $\xi = (1, 1)^T$ . One solution is

$$\mathbf{x}^{(1)} = \begin{pmatrix} 1 \\ 1 \end{pmatrix} e^{-t}.$$

A second linearly independent solution is obtained by solving the system

$$\begin{pmatrix} -\frac{3}{2} & \frac{3}{2} \\ -\frac{3}{2} & \frac{3}{2} \end{pmatrix} \begin{pmatrix} \eta_1 \\ \eta_2 \end{pmatrix} = \begin{pmatrix} 1 \\ 1 \end{pmatrix}.$$

The equations reduce to the single equation  $-3\eta_1 + 3\eta_2 = 2$ . Let  $\eta_1 = k$ . We obtain  $\eta_2 = 2/3 + k$ , and a second linearly independent solution is

$$\begin{aligned} \mathbf{x}^{(2)} &= \begin{pmatrix} 1 \\ 1 \end{pmatrix} t e^{-t} + \begin{pmatrix} k \\ 2/3 + k \end{pmatrix} e^{-t} \\ &= \begin{pmatrix} 1 \\ 1 \end{pmatrix} t e^{-t} + \begin{pmatrix} 0 \\ 2/3 \end{pmatrix} e^{-t} + k \begin{pmatrix} 1 \\ 1 \end{pmatrix} e^{-t}. \end{aligned}$$

Dropping the last term, the general solution is

$$\mathbf{x} = c_1 \begin{pmatrix} 1 \\ 1 \end{pmatrix} e^{-t} + c_2 \left[ \begin{pmatrix} 1 \\ 1 \end{pmatrix} t e^{-t} + \begin{pmatrix} 0 \\ 2/3 \end{pmatrix} e^{-t} \right].$$

Imposing the initial conditions, find that



$$\begin{aligned} c_1 &= 3 \\ c_1 + \frac{2}{3}c_2 &= -1, \end{aligned}$$

so that  $c_1 = 3$  and  $c_2 = -6$ . Therefore the solution of the IVP is

$$\mathbf{x} = \begin{pmatrix} 3 \\ -1 \end{pmatrix} e^{-t} - \begin{pmatrix} 6 \\ 6 \end{pmatrix} t e^{-t}.$$

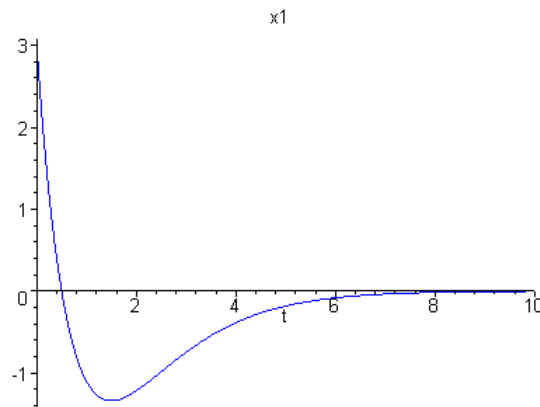
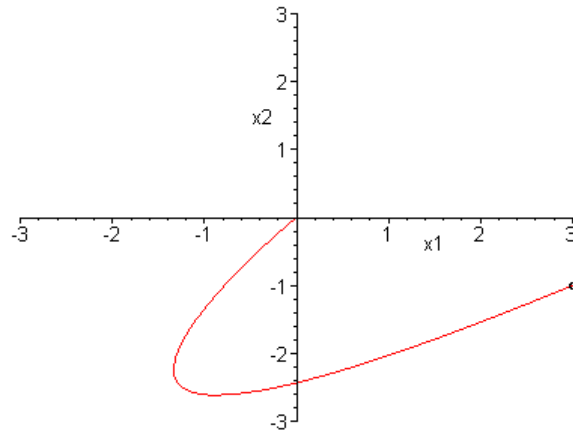

10. The eigensystem is obtained from analysis of the equation

$$\begin{pmatrix} 3 - r & 9 \\ -1 & -3 - r \end{pmatrix} \begin{pmatrix} \xi_1 \\ \xi_2 \end{pmatrix} = \begin{pmatrix} 0 \\ 0 \end{pmatrix}.$$

The characteristic equation is  $r^2 = 0$ , with a single root  $r = 0$ . Setting  $r = 0$ , the two equations reduce to  $\xi_1 + 3\xi_2 = 0$ . The corresponding eigenvector is  $\boldsymbol{\xi} = (-3, 1)^T$ . Hence one solution is

$$\mathbf{x}^{(1)} = \begin{pmatrix} -3 \\ 1 \end{pmatrix},$$

which is a constant vector. A second linearly independent solution is obtained from the system

$$\begin{pmatrix} 3 & 9 \\ -1 & -3 \end{pmatrix} \begin{pmatrix} \eta_1 \\ \eta_2 \end{pmatrix} = \begin{pmatrix} -3 \\ 1 \end{pmatrix}.$$

The equations reduce to the single equation  $\eta_1 + 3\eta_2 = -1$ . Let  $\eta_2 = k$ . We obtain  $\eta_1 = -1 - 3k$ , and a second linearly independent solution is

$$\begin{aligned} \mathbf{x}^{(2)} &= \begin{pmatrix} -3 \\ 1 \end{pmatrix} t + \begin{pmatrix} -1 - 3k \\ k \end{pmatrix} \\ &= \begin{pmatrix} -3 \\ 1 \end{pmatrix} t + \begin{pmatrix} -1 \\ 0 \end{pmatrix} + k \begin{pmatrix} -3 \\ 1 \end{pmatrix}. \end{aligned}$$

Dropping the last term, the general solution is

$$\mathbf{x} = c_1 \begin{pmatrix} -3 \\ 1 \end{pmatrix} + c_2 \left[ \begin{pmatrix} -3 \\ 1 \end{pmatrix} t + \begin{pmatrix} -1 \\ 0 \end{pmatrix} \right].$$

Imposing the initial conditions, we require that

$$\begin{aligned} -3c_1 - c_2 &= 2 \\ c_1 &= 4, \end{aligned}$$

which results in  $c_1 = 4$  and  $c_2 = -14$ . Therefore the solution of the IVP is

$$\mathbf{x} = \begin{pmatrix} 2 \\ 4 \end{pmatrix} - 14 \begin{pmatrix} -3 \\ 1 \end{pmatrix} t.$$

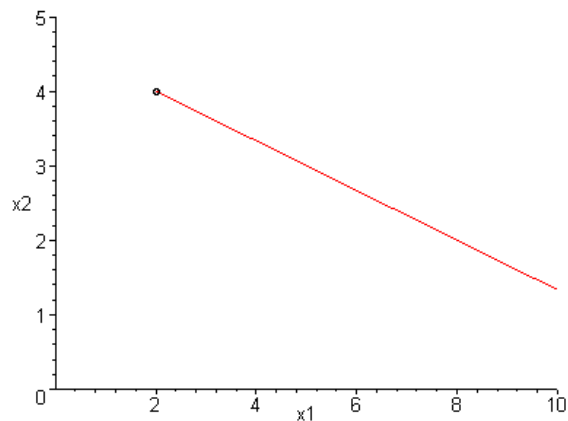

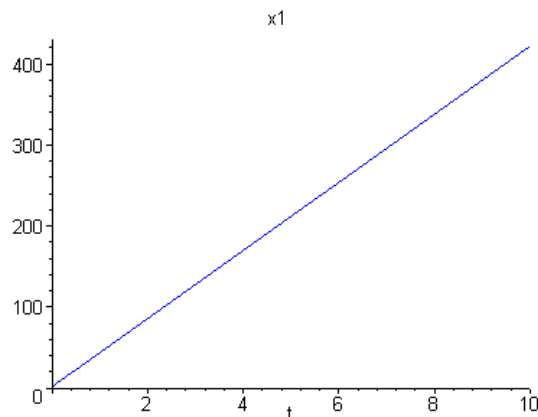

12. The characteristic equation of the system is  $8r^3 + 60r^2 + 126r + 49 = 0$ . The eigenvalues are  $r_1 = -1/2$  and  $r_{2,3} = -7/2$ . The eigenvector associated with  $r_1$  is  $\xi^{(1)} = (1, 1, 1)^T$ . Setting  $r = -7/2$ , the components of the eigenvectors must satisfy the relation

$$\xi_1 + \xi_2 + \xi_3 = 0.$$

An eigenvector vector is given by  $\xi^{(2)} = (1, 0, -1)^T$ . Since the last equation has two free variables, a third linearly independent eigenvector (associated with  $r = -7/2$ ) is  $\xi^{(3)} = (0, 1, -1)^T$ . Therefore the general solution may be written as

$$\mathbf{x} = c_1 \begin{pmatrix} 1 \\ 1 \\ 1 \end{pmatrix} e^{-t/2} + c_2 \begin{pmatrix} 1 \\ 0 \\ -1 \end{pmatrix} e^{-7t/2} + c_3 \begin{pmatrix} 0 \\ 1 \\ -1 \end{pmatrix} e^{-7t/2}.$$

Invoking the initial conditions, we require that

$$\begin{aligned} c_1 + c_2 &= 2 \\ c_1 + c_3 &= 3 \\ c_1 - c_2 - c_3 &= -1. \end{aligned}$$

Hence the solution of the IVP is

$$\mathbf{x} = \frac{4}{3} \begin{pmatrix} 1 \\ 1 \\ 1 \end{pmatrix} e^{-t/2} + \frac{2}{3} \begin{pmatrix} 1 \\ 0 \\ -1 \end{pmatrix} e^{-7t/2} + \frac{5}{3} \begin{pmatrix} 0 \\ 1 \\ -1 \end{pmatrix} e^{-7t/2}.$$

13. Setting  $\mathbf{x} = \xi t^r$  results in the algebraic equations

$$\begin{pmatrix} 3-r & -4 \\ 1 & -1-r \end{pmatrix} \begin{pmatrix} \xi_1 \\ \xi_2 \end{pmatrix} = \begin{pmatrix} 0 \\ 0 \end{pmatrix}.$$

The characteristic equation is  $r^2 - 2r + 1 = 0$ , with a single root of  $r_{1,2} = 1$ . With

$r = 1$ , the system reduces to a single equation  $\xi_1 - 2\xi_2 = 0$ . An eigenvector is given by  $\xi = (2, 1)^T$ . Hence one solution is

$$\mathbf{x}^{(1)} = \begin{pmatrix} 2 \\ 1 \end{pmatrix} t.$$

In order to find a second linearly independent solution, we search for a *generalized eigenvector* whose components satisfy

$$\begin{pmatrix} 2 & -4 \\ 1 & -2 \end{pmatrix} \begin{pmatrix} \eta_1 \\ \eta_2 \end{pmatrix} = \begin{pmatrix} 2 \\ 1 \end{pmatrix}.$$

These equations reduce to  $\eta_1 - 2\eta_2 = 1$ . Let  $\eta_2 = k$ , some arbitrary constant. Then  $\eta_1 = 1 + 2k$ . [Before proceeding, note that if we set  $u = \ln t$ , the original equation is transformed into a constant coefficient equation with independent variable  $u$ . Recall that a second solution is obtained by multiplication of the first solution by the factor  $u$ . This implies that we must multiply first solution by a factor of  $\ln t$ .] Hence a second linearly independent solution is

$$\begin{aligned} \mathbf{x}^{(2)} &= \begin{pmatrix} 2 \\ 1 \end{pmatrix} t \ln t + \begin{pmatrix} 1 + 2k \\ k \end{pmatrix} t \\ &= \begin{pmatrix} 2 \\ 1 \end{pmatrix} t \ln t + \begin{pmatrix} 1 \\ 0 \end{pmatrix} t + k \begin{pmatrix} 2 \\ 1 \end{pmatrix} t. \end{aligned}$$

Dropping the last term, the general solution is

$$\mathbf{x} = c_1 \begin{pmatrix} 2 \\ 1 \end{pmatrix} t + c_2 \left[ \begin{pmatrix} 2 \\ 1 \end{pmatrix} t \ln t + \begin{pmatrix} 1 \\ 0 \end{pmatrix} t \right].$$

15. The characteristic equation is

$$r^2 - (a + d)r + ad - bc = 0.$$

Hence the eigenvalues are

$$r_{1,2} = \frac{a + d}{2} \pm \frac{1}{2} \sqrt{(a + d)^2 - 4(ad - bc)}.$$

16(a). Using the result in Prob. 15, the eigenvalues are

$$r_{1,2} = -\frac{1}{2RC} \pm \frac{\sqrt{L^2 - 4R^2CL}}{2RCL}.$$

The discriminant vanishes when  $L = 4R^2CL$ .

(b). The system of differential equations is

$$\frac{d}{dt} \begin{pmatrix} I \\ V \end{pmatrix} = \begin{pmatrix} 0 & \frac{1}{4} \\ -1 & -1 \end{pmatrix} \begin{pmatrix} I \\ V \end{pmatrix}.$$

The associated eigenvalue problem is

$$\begin{pmatrix} -r & \frac{1}{4} \\ -1 & -1-r \end{pmatrix} \begin{pmatrix} \xi_1 \\ \xi_2 \end{pmatrix} = \begin{pmatrix} 0 \\ 0 \end{pmatrix}.$$

The characteristic equation is  $r^2 + r + 1/4 = 0$ , with a single root of  $r_{1,2} = -1/2$ . Setting  $r = -1/2$ , the algebraic equations reduce to  $2\xi_1 + \xi_2 = 0$ . An eigenvector is given by  $\xi = (1, -2)^T$ . Hence one solution is

$$\begin{pmatrix} I \\ V \end{pmatrix}^{(1)} = \begin{pmatrix} 1 \\ -2 \end{pmatrix} e^{-t/2}.$$

A second solution is obtained from a generalized eigenvector whose components satisfy

$$\begin{pmatrix} \frac{1}{2} & \frac{1}{4} \\ -1 & -\frac{1}{2} \end{pmatrix} \begin{pmatrix} \eta_1 \\ \eta_2 \end{pmatrix} = \begin{pmatrix} 1 \\ -2 \end{pmatrix}.$$

It follows that  $\eta_1 = k$  and  $\eta_2 = 4 - 2k$ . A second linearly independent solution is

$$\begin{aligned} \begin{pmatrix} I \\ V \end{pmatrix}^{(2)} &= \begin{pmatrix} 1 \\ -2 \end{pmatrix} t e^{-t/2} + \begin{pmatrix} k \\ 4 - 2k \end{pmatrix} e^{-t/2} \\ &= \begin{pmatrix} 1 \\ -2 \end{pmatrix} t e^{-t/2} + \begin{pmatrix} 0 \\ 4 \end{pmatrix} e^{-t/2} + k \begin{pmatrix} 1 \\ -2 \end{pmatrix} e^{-t/2}. \end{aligned}$$

Dropping the last term, the general solution is

$$\begin{pmatrix} I \\ V \end{pmatrix} = c_1 \begin{pmatrix} 1 \\ -2 \end{pmatrix} e^{-t/2} + c_2 \left[ \begin{pmatrix} 1 \\ -2 \end{pmatrix} t e^{-t/2} + \begin{pmatrix} 0 \\ 4 \end{pmatrix} e^{-t/2} \right].$$

Imposing the initial conditions, we require that

$$\begin{aligned} c_1 &= 1 \\ -2c_1 + 4c_2 &= 2, \end{aligned}$$

which results in  $c_1 = 1$  and  $c_2 = 1$ . Therefore the solution of the IVP is

$$\begin{pmatrix} I \\ V \end{pmatrix} = \begin{pmatrix} 1 \\ 2 \end{pmatrix} e^{-t/2} + \begin{pmatrix} 1 \\ -2 \end{pmatrix} t e^{-t/2}.$$

18(a). The eigensystem is obtained from analysis of the equation

$$\begin{pmatrix} 5-r & -3 & -2 \\ 8 & -5-r & -4 \\ -4 & 3 & 3-r \end{pmatrix} \begin{pmatrix} \xi_1 \\ \xi_2 \\ \xi_3 \end{pmatrix} = \begin{pmatrix} 0 \\ 0 \\ 0 \end{pmatrix}.$$

The characteristic equation of the coefficient matrix is  $r^3 - 3r^2 + 3r - 1 = 0$ , with a single root of *multiplicity three*,  $r = 1$ . Setting  $r = 1$ , we have

$$\begin{pmatrix} 4 & -3 & -2 \\ 8 & -6 & -4 \\ -4 & 3 & 2 \end{pmatrix} \begin{pmatrix} \xi_1 \\ \xi_2 \\ \xi_3 \end{pmatrix} = \begin{pmatrix} 0 \\ 0 \\ 0 \end{pmatrix}.$$

The system of algebraic equations reduce to a single equation

$$4\xi_1 - 3\xi_2 - 2\xi_3 = 0.$$

An eigenvector vector is given by  $\boldsymbol{\xi}^{(1)} = (1, 0, 2)^T$ . Since the last equation has two free variables, a second linearly independent eigenvector (associated with  $r = 1$ ) is  $\boldsymbol{\xi}^{(2)} = (0, 2, -3)^T$ . Therefore two solutions are obtained as

$$\mathbf{x}^{(1)} = \begin{pmatrix} 1 \\ 0 \\ 2 \end{pmatrix} e^t \quad \text{and} \quad \mathbf{x}^{(2)} = \begin{pmatrix} 0 \\ 2 \\ -3 \end{pmatrix} e^t.$$

(b). It follows directly that  $\mathbf{x}' = \boldsymbol{\xi}te^t + \boldsymbol{\xi}e^t + \boldsymbol{\eta}e^t$ . Hence the coefficient vectors must satisfy  $\boldsymbol{\xi}te^t + \boldsymbol{\xi}e^t + \boldsymbol{\eta}e^t = \mathbf{A}\boldsymbol{\xi}te^t + \mathbf{A}\boldsymbol{\eta}e^t$ . Rearranging the terms, we have

$$\boldsymbol{\xi}e^t = (\mathbf{A} - \mathbf{I})\boldsymbol{\xi}te^t + (\mathbf{A} - \mathbf{I})\boldsymbol{\eta}e^t.$$

Given an eigenvector  $\boldsymbol{\xi}$ , it follows that  $(\mathbf{A} - \mathbf{I})\boldsymbol{\eta} = \boldsymbol{\xi}$ .

(c). Note that a linear combination of two eigenvectors, associated with the *same* eigenvalue, is also an eigenvector. Consider the equation  $(\mathbf{A} - \mathbf{I})\boldsymbol{\eta} = c_1\boldsymbol{\xi}^{(1)} + c_2\boldsymbol{\xi}^{(2)}$ . The *augmented* matrix is

$$\left( \begin{array}{ccc|c} 4 & -3 & -2 & c_1 \\ 8 & -6 & -4 & 2c_2 \\ -4 & 3 & 2 & 2c_1 - 3c_2 \end{array} \right).$$

Using elementary row operations, we obtain

$$\left( \begin{array}{ccc|c} 4 & -3 & -2 & c_1 \\ 0 & 0 & 0 & -2c_1 + 2c_2 \\ 0 & 0 & 0 & 3c_1 - 3c_2 \end{array} \right).$$

It is evident that a solution exists provided  $c_1 = c_2$ .

(d). Let  $c_1 = c_2 = 2$ . The components of the generalized eigenvector must satisfy

$$\begin{pmatrix} 4 & -3 & -2 \\ 8 & -6 & -4 \\ -4 & 3 & 2 \end{pmatrix} \begin{pmatrix} \eta_1 \\ \eta_2 \\ \eta_3 \end{pmatrix} = \begin{pmatrix} 2 \\ 4 \\ -2 \end{pmatrix}.$$

Based on Part (c), the equations reduce to the single equation  $4\eta_1 - 3\eta_2 - 2\eta_3 = 2$ . Let  $\eta_1 = \alpha$  and  $\eta_2 = 2\beta$ , where  $\alpha$  and  $\beta$  are arbitrary constants. We then have

$$\eta_3 = -1 + 2\alpha - 3\beta,$$

so that

$$\boldsymbol{\eta} = \begin{pmatrix} \alpha \\ 2\beta \\ -1 + 2\alpha - 3\beta \end{pmatrix} = \begin{pmatrix} 0 \\ 0 \\ -1 \end{pmatrix} + \alpha \begin{pmatrix} 1 \\ 0 \\ 2 \end{pmatrix} + \beta \begin{pmatrix} 0 \\ 2 \\ -3 \end{pmatrix}.$$

Observe that  $\boldsymbol{\eta} = \alpha \boldsymbol{\xi}^{(1)} + \beta \boldsymbol{\xi}^{(2)}$ . Hence a third linearly independent solution is

$$\mathbf{x}^{(3)} = \begin{pmatrix} 2 \\ 4 \\ -2 \end{pmatrix} t e^t + \begin{pmatrix} 0 \\ 0 \\ -1 \end{pmatrix} e^t.$$

(e). Given the three linearly independent solutions, a fundamental matrix is given by

$$\boldsymbol{\Psi}(t) = \begin{pmatrix} e^t & 0 & 2t e^t \\ 0 & 2e^t & 4t e^t \\ 2e^t & -3e^t & -2t e^t - e^t \end{pmatrix}.$$

(f). We construct the transformation matrix

$$\mathbf{T} = \begin{pmatrix} 1 & 2 & 0 \\ 0 & 4 & 0 \\ 2 & -2 & -1 \end{pmatrix},$$

with inverse

$$\mathbf{T}^{-1} = \begin{pmatrix} 1 & -1/2 & 0 \\ 0 & 1/4 & 0 \\ 2 & -3/2 & -1 \end{pmatrix}.$$

The *Jordan form* of the matrix  $\mathbf{A}$  is

$$\mathbf{J} = \mathbf{T}^{-1} \mathbf{A} \mathbf{T} = \begin{pmatrix} 1 & 0 & 0 \\ 0 & 1 & 1 \\ 0 & 0 & 1 \end{pmatrix}.$$

20(a). Direct multiplication results in

$$\mathbf{J}^2 = \begin{pmatrix} \lambda^2 & 0 & 0 \\ 0 & \lambda^2 & 2\lambda \\ 0 & 0 & \lambda^2 \end{pmatrix}, \mathbf{J}^3 = \begin{pmatrix} \lambda^3 & 0 & 0 \\ 0 & \lambda^3 & 3\lambda^2 \\ 0 & 0 & \lambda^3 \end{pmatrix}, \mathbf{J}^4 = \begin{pmatrix} \lambda^4 & 0 & 0 \\ 0 & \lambda^4 & 4\lambda^3 \\ 0 & 0 & \lambda^4 \end{pmatrix}.$$

(b). Suppose that

$$\mathbf{J}^n = \begin{pmatrix} \lambda^n & 0 & 0 \\ 0 & \lambda^n & n\lambda^{n-1} \\ 0 & 0 & \lambda^n \end{pmatrix}.$$

Then

$$\begin{aligned} \mathbf{J}^{n+1} &= \begin{pmatrix} \lambda^n & 0 & 0 \\ 0 & \lambda^n & n\lambda^{n-1} \\ 0 & 0 & \lambda^n \end{pmatrix} \begin{pmatrix} \lambda & 0 & 0 \\ 0 & \lambda & 1 \\ 0 & 0 & \lambda \end{pmatrix} \\ &= \begin{pmatrix} \lambda \cdot \lambda^n & 0 & 0 \\ 0 & \lambda \cdot \lambda^n & \lambda^n + n\lambda \cdot \lambda^{n-1} \\ 0 & 0 & \lambda \cdot \lambda^n \end{pmatrix}. \end{aligned}$$

Hence the result follows by mathematical induction.

(c). Note that  $\mathbf{J}$  is *block diagonal*. Hence each *block* may be *exponentiated*. Using the result in Prob. (19),

$$\exp(\mathbf{J}t) = \begin{pmatrix} e^{\lambda t} & 0 & 0 \\ 0 & e^{\lambda t} & te^{\lambda t} \\ 0 & 0 & e^{\lambda t} \end{pmatrix}.$$

(d). Setting  $\lambda = 1$ , and using the transformation matrix  $\mathbf{T}$  in Prob. (18),

$$\begin{aligned} \mathbf{T}\exp(\mathbf{J}t) &= \begin{pmatrix} 1 & 2 & 0 \\ 0 & 4 & 0 \\ 2 & -2 & -1 \end{pmatrix} \begin{pmatrix} e^t & 0 & 0 \\ 0 & e^t & te^t \\ 0 & 0 & e^t \end{pmatrix} \\ &= \begin{pmatrix} e^t & 2e^t & 2te^t \\ 0 & 4e^t & 4te^t \\ 2e^t & -2e^t & -2te^t - e^t \end{pmatrix}. \end{aligned}$$

Based on the form of  $\mathbf{J}$ ,  $\exp(\mathbf{J}t)$  is the fundamental matrix associated with the solutions

$$\mathbf{y}^{(1)} = \boldsymbol{\xi}^{(1)}e^t, \mathbf{y}^{(2)} = (2\boldsymbol{\xi}^{(1)} + 2\boldsymbol{\xi}^{(2)})e^t \text{ and } \mathbf{y}^{(3)} = (2\boldsymbol{\xi}^{(1)} + 2\boldsymbol{\xi}^{(2)})te^t + \boldsymbol{\eta}e^t.$$

Hence the resulting matrix is the fundamental matrix associated with the solution set



$$\{\xi^{(1)}e^t, (2\xi^{(1)} + 2\xi^{(2)})e^t, (2\xi^{(1)} + 2\xi^{(2)})te^t + \eta e^t\},$$

as opposed to the solution set in Prob. (18), given by

$$\{\xi^{(1)}e^t, \xi^{(2)}e^t, (2\xi^{(1)} + 2\xi^{(2)})te^t + \eta e^t\}.$$

21(a). Direct multiplication results in

$$\mathbf{J}^2 = \begin{pmatrix} \lambda^2 & 2\lambda & 1 \\ 0 & \lambda^2 & 2\lambda \\ 0 & 0 & \lambda^2 \end{pmatrix}, \mathbf{J}^3 = \begin{pmatrix} \lambda^3 & 3\lambda^2 & 3\lambda \\ 0 & \lambda^3 & 3\lambda^2 \\ 0 & 0 & \lambda^3 \end{pmatrix}, \mathbf{J}^4 = \begin{pmatrix} \lambda^4 & 4\lambda^3 & 6\lambda^2 \\ 0 & \lambda^4 & 4\lambda^3 \\ 0 & 0 & \lambda^4 \end{pmatrix}.$$

(b). Suppose that

$$\mathbf{J}^n = \begin{pmatrix} \lambda^n & n\lambda^{n-1} & \frac{n(n-1)}{2}\lambda^{n-2} \\ 0 & \lambda^n & n\lambda^{n-1} \\ 0 & 0 & \lambda^n \end{pmatrix}.$$

Then

$$\begin{aligned} \mathbf{J}^{n+1} &= \begin{pmatrix} \lambda^n & n\lambda^{n-1} & \frac{n(n-1)}{2}\lambda^{n-2} \\ 0 & \lambda^n & n\lambda^{n-1} \\ 0 & 0 & \lambda^n \end{pmatrix} \begin{pmatrix} \lambda & 1 & 0 \\ 0 & \lambda & 1 \\ 0 & 0 & \lambda \end{pmatrix} \\ &= \begin{pmatrix} \lambda \cdot \lambda^n & \lambda^n + n\lambda \cdot \lambda^{n-1} & n\lambda^{n-1} + \frac{n(n-1)}{2}\lambda \cdot \lambda^{n-2} \\ 0 & \lambda \cdot \lambda^n & \lambda^n + n\lambda \cdot \lambda^{n-1} \\ 0 & 0 & \lambda \cdot \lambda^n \end{pmatrix}. \end{aligned}$$

The result follows by noting that

$$\begin{aligned} n\lambda^{n-1} + \frac{n(n-1)}{2}\lambda \cdot \lambda^{n-2} &= \left[ n + \frac{n(n-1)}{2} \right] \lambda^{n-1} \\ &= \frac{n^2 + n}{2} \lambda^{n-1}. \end{aligned}$$

(c). We first observe that

$$\begin{aligned} \sum_{n=0}^{\infty} \lambda^n \frac{t^n}{n!} &= e^{\lambda t} \\ \sum_{n=0}^{\infty} n \lambda^{n-1} \frac{t^n}{n!} &= t \sum_{n=1}^{\infty} \lambda^{n-1} \frac{t^{n-1}}{(n-1)!} = t e^{\lambda t} \\ \sum_{n=0}^{\infty} \frac{n(n-1)}{2} \lambda^{n-2} \frac{t^n}{n!} &= \frac{t^2}{2} \sum_{n=2}^{\infty} \lambda^{n-2} \frac{t^{n-2}}{(n-2)!} = \frac{t^2}{2} e^{\lambda t}. \end{aligned}$$

Therefore

$$\exp(\mathbf{J}t) = \begin{pmatrix} e^{\lambda t} & te^{\lambda t} & \frac{t^2}{2}e^{\lambda t} \\ 0 & e^{\lambda t} & te^{\lambda t} \\ 0 & 0 & e^{\lambda t} \end{pmatrix}.$$

(d). Setting  $\lambda = 2$ , and using the transformation matrix  $\mathbf{T}$  in Prob. (17),

$$\begin{aligned} \mathbf{T} \exp(\mathbf{J}t) &= \begin{pmatrix} 0 & 1 & 2 \\ 1 & 1 & 0 \\ -1 & 0 & 3 \end{pmatrix} \begin{pmatrix} e^{2t} & te^{2t} & \frac{t^2}{2}e^{2t} \\ 0 & e^{2t} & te^{2t} \\ 0 & 0 & e^{2t} \end{pmatrix} \\ &= \begin{pmatrix} 0 & e^{2t} & te^{2t} + 2e^{2t} \\ e^{2t} & te^{2t} + e^{2t} & \frac{t^2}{2}e^{2t} + te^{2t} \\ -e^{2t} & -te^{2t} & -\frac{t^2}{2}e^{2t} + 3e^{2t} \end{pmatrix}. \end{aligned}$$

## Section 7.9

5. As shown in Prob. 2, Section 7.8, the general solution of the homogeneous equation is

$$\mathbf{x}_c = c_1 \begin{pmatrix} 1 \\ 2 \end{pmatrix} + c_2 \begin{pmatrix} t \\ 2t - \frac{1}{2} \end{pmatrix}.$$

An associated fundamental matrix is

$$\Psi(t) = \begin{pmatrix} 1 & t \\ 2 & 2t - \frac{1}{2} \end{pmatrix}.$$

The inverse of the fundamental matrix is easily determined as

$$\Psi^{-1}(t) = \begin{pmatrix} 4t - 3 & -2t + 2 \\ 8t - 8 & -4t + 5 \end{pmatrix}.$$

We can now compute

$$\Psi^{-1}(t)\mathbf{g}(t) = -\frac{1}{t^3} \begin{pmatrix} 2t^2 + 4t - 1 \\ -2t - 4 \end{pmatrix},$$

and

$$\int \Psi^{-1}(t)\mathbf{g}(t) dt = \begin{pmatrix} -\frac{1}{2}t^{-2} + 4t^{-1} - 2\ln t \\ -2t^{-2} - 2t^{-1} \end{pmatrix}.$$

Finally,

$$\mathbf{v}(t) = \Psi(t) \int \Psi^{-1}(t)\mathbf{g}(t) dt,$$

where

$$\begin{aligned} v_1(t) &= -\frac{1}{2}t^{-2} + 2t^{-1} - 2\ln t - 2 \\ v_2(t) &= 5t^{-1} - 4\ln t - 4. \end{aligned}$$

Note that the vector  $(2, 4)^T$  is a multiple of one of the fundamental solutions. Hence we can write the general solution as

$$\mathbf{x} = c_1 \begin{pmatrix} 1 \\ 2 \end{pmatrix} + c_2 \begin{pmatrix} t \\ 2t - \frac{1}{2} \end{pmatrix} - \frac{1}{t^2} \begin{pmatrix} 1/2 \\ 0 \end{pmatrix} + \frac{1}{t} \begin{pmatrix} 2 \\ 5 \end{pmatrix} - 2\ln t \begin{pmatrix} 1 \\ 2 \end{pmatrix}.$$

6. The eigenvalues of the coefficient matrix are  $r_1 = 0$  and  $r_2 = -5$ . It follows that the solution of the homogeneous equation is

$$\mathbf{x}_c = c_1 \begin{pmatrix} 1 \\ 2 \end{pmatrix} + c_2 \begin{pmatrix} -2e^{-5t} \\ e^{-5t} \end{pmatrix}.$$

The coefficient matrix is *symmetric*. Hence the system is diagonalizable. Using the *normalized* eigenvectors as columns, the transformation matrix, and its inverse, are

$$\mathbf{T} = \frac{1}{\sqrt{5}} \begin{pmatrix} 1 & -2 \\ 2 & 1 \end{pmatrix}, \quad \mathbf{T}^{-1} = \frac{1}{\sqrt{5}} \begin{pmatrix} 1 & 2 \\ -2 & 1 \end{pmatrix}.$$

Setting  $\mathbf{x} = \mathbf{T}\mathbf{y}$ , and  $\mathbf{h}(t) = \mathbf{T}^{-1}\mathbf{g}(t)$ , the transformed system is given, in scalar form, as

$$\begin{aligned} y_1' &= \frac{5+8t}{\sqrt{5}} \\ y_2' &= -5y_2 + \frac{4}{\sqrt{5}}. \end{aligned}$$

The solutions are readily obtained as

$$y_1(t) = \sqrt{5} \ln t + \frac{4}{\sqrt{5}} t + c_1 \quad \text{and} \quad y_2(t) = c_2 e^{-5t} + \frac{4}{5\sqrt{5}}.$$

Transforming back to the original variables, we have  $\mathbf{x} = \mathbf{T}\mathbf{y}$ , with

$$\begin{aligned} \mathbf{x} &= \frac{1}{\sqrt{5}} \begin{pmatrix} 1 & -2 \\ 2 & 1 \end{pmatrix} \begin{pmatrix} y_1(t) \\ y_2(t) \end{pmatrix} \\ &= \frac{1}{\sqrt{5}} \begin{pmatrix} 1 \\ 2 \end{pmatrix} y_1(t) + \frac{1}{\sqrt{5}} \begin{pmatrix} -2 \\ 1 \end{pmatrix} y_2(t). \end{aligned}$$

Hence the general solution is,

$$\mathbf{x} = k_1 \begin{pmatrix} 1 \\ 2 \end{pmatrix} + k_2 \begin{pmatrix} -2e^{-5t} \\ e^{-5t} \end{pmatrix} + \begin{pmatrix} 1 \\ 2 \end{pmatrix} \ln t + \frac{4}{5} \begin{pmatrix} 1 \\ 2 \end{pmatrix} t + \frac{4}{25} \begin{pmatrix} -2 \\ 1 \end{pmatrix}.$$

7. The solution of the homogeneous equation is

$$\mathbf{x}_c = c_1 \begin{pmatrix} e^{-t} \\ -2e^{-t} \end{pmatrix} + c_2 \begin{pmatrix} e^{3t} \\ 2e^{3t} \end{pmatrix}.$$

Based on the simple form of the right hand side, we use the method of *undetermined coefficients*. Set  $\mathbf{v} = \mathbf{a} e^t$ . Substitution into the ODE yields

$$\begin{pmatrix} a_1 \\ a_2 \end{pmatrix} e^t = \begin{pmatrix} 1 & 1 \\ 4 & 1 \end{pmatrix} \begin{pmatrix} a_1 \\ a_2 \end{pmatrix} e^t + \begin{pmatrix} 2 \\ -1 \end{pmatrix} e^t.$$

In scalar form, after canceling the exponential, we have

$$\begin{aligned}a_1 &= a_1 + a_2 + 2 \\a_2 &= 4a_1 + a_2 - 1,\end{aligned}$$

with  $a_1 = 1/4$  and  $a_2 = -2$ . Hence the particular solution is

$$\mathbf{v} = \begin{pmatrix} 1/4 \\ -2 \end{pmatrix} e^t,$$

so that the general solution is

$$\mathbf{x} = c_1 \begin{pmatrix} e^{-t} \\ -2e^{-t} \end{pmatrix} + c_2 \begin{pmatrix} e^{3t} \\ 2e^{3t} \end{pmatrix} + \frac{1}{4} \begin{pmatrix} e^t \\ -8e^t \end{pmatrix}.$$

8. The eigenvalues of the coefficient matrix are  $r_1 = 1$  and  $r_2 = -1$ . It follows that the solution of the homogeneous equation is

$$\mathbf{x}_c = c_1 \begin{pmatrix} 1 \\ 1 \end{pmatrix} e^t + c_2 \begin{pmatrix} 1 \\ 3 \end{pmatrix} e^{-t}.$$

Use the method of *undetermined coefficients*. Since the right hand side is related to one of the fundamental solutions, set  $\mathbf{v} = \mathbf{a}te^t + \mathbf{b}e^t$ . Substitution into the ODE yields

$$\begin{aligned}\begin{pmatrix} a_1 \\ a_2 \end{pmatrix} (e^t + te^t) + \begin{pmatrix} b_1 \\ b_2 \end{pmatrix} e^t &= \begin{pmatrix} 2 & -1 \\ 3 & -2 \end{pmatrix} \begin{pmatrix} a_1 \\ a_2 \end{pmatrix} te^t + \\ &+ \begin{pmatrix} 2 & -1 \\ 3 & -2 \end{pmatrix} \begin{pmatrix} b_1 \\ b_2 \end{pmatrix} e^t + \begin{pmatrix} 1 \\ -1 \end{pmatrix} e^t.\end{aligned}$$

In scalar form, we have

$$\begin{aligned}(a_1 + b_1)e^t + a_1te^t &= (2a_1 - a_2)te^t + (2b_1 - b_2)e^t + e^t \\(a_2 + b_2)e^t + a_2te^t &= (3a_1 - 2a_2)te^t + (3b_1 - 2b_2)e^t - e^t.\end{aligned}$$

Equating the coefficients in these two equations, we find that

$$\begin{aligned}a_1 &= 2a_1 - a_2 \\a_1 + b_1 &= 2b_1 - b_2 + 1 \\a_2 &= 3a_1 - 2a_2 \\a_2 + b_2 &= 3b_1 - 2b_2 - 1.\end{aligned}$$

It follows that  $a_1 = a_2$ . Setting  $a_1 = a_2 = a$ , the equations reduce to

$$\begin{aligned}b_1 - b_2 &= a - 1 \\3b_1 - 3b_2 &= 1 + a.\end{aligned}$$

Combining these equations, it is necessary that  $a = 2$ . As a result,  $b_1 = b_2 + 1$ . Choosing  $a_1 = a_2 = 2$ , and  $b_2 = k$ , some arbitrary constant, a particular solution is

$$\mathbf{v} = \begin{pmatrix} 2 \\ 2 \end{pmatrix} te^t + \begin{pmatrix} k+1 \\ k \end{pmatrix} e^t = \begin{pmatrix} 2 \\ 2 \end{pmatrix} te^t + k \begin{pmatrix} 1 \\ 1 \end{pmatrix} e^t + \begin{pmatrix} 1 \\ 0 \end{pmatrix} e^t.$$

Since the *second* vector is a fundamental solution, the general solution can be written as

$$\mathbf{x} = c_1 \begin{pmatrix} 1 \\ 1 \end{pmatrix} e^t + c_2 \begin{pmatrix} 1 \\ 3 \end{pmatrix} e^{-t} + \begin{pmatrix} 2 \\ 2 \end{pmatrix} te^t + \begin{pmatrix} 1 \\ 0 \end{pmatrix} e^t.$$

9. Note that the coefficient matrix is *symmetric*. Hence the system is diagonalizable. The eigenvalues and eigenvectors are given by

$$r_1 = -\frac{1}{2}, \quad \boldsymbol{\xi}^{(1)} = \begin{pmatrix} 1 \\ 1 \end{pmatrix} \quad \text{and} \quad r_2 = -2, \quad \boldsymbol{\xi}^{(2)} = \begin{pmatrix} 1 \\ -1 \end{pmatrix}.$$

Using the *normalized* eigenvectors as columns, the transformation matrix, and its inverse, are

$$\mathbf{T} = \frac{1}{\sqrt{2}} \begin{pmatrix} 1 & 1 \\ 1 & -1 \end{pmatrix}, \quad \mathbf{T}^{-1} = \frac{1}{\sqrt{2}} \begin{pmatrix} 1 & 1 \\ 1 & -1 \end{pmatrix}.$$

Setting  $\mathbf{x} = \mathbf{T}\mathbf{y}$ , and  $\mathbf{h}(t) = \mathbf{T}^{-1}\mathbf{g}(t)$ , the transformed system is given, in scalar form, as

$$\begin{aligned} y_1' &= -\frac{1}{2}y_1 + \sqrt{2}t + \frac{1}{\sqrt{2}}e^t \\ y_2' &= -2y_2 + \sqrt{2}t - \frac{1}{\sqrt{2}}e^t. \end{aligned}$$

Using any elementary method for first order linear equations, the solutions are

$$\begin{aligned} y_1(t) &= k_1 e^{-t/2} + \frac{\sqrt{2}}{3} e^t - 4\sqrt{2} + 2\sqrt{2}t \\ y_2(t) &= k_2 e^{-2t} - \frac{1}{3\sqrt{2}} e^t - \frac{1}{2\sqrt{2}} + \frac{1}{\sqrt{2}}t. \end{aligned}$$

Transforming back to the original variables,  $\mathbf{x} = \mathbf{T}\mathbf{y}$ , the general solution is

$$\mathbf{x} = c_1 \begin{pmatrix} 1 \\ 1 \end{pmatrix} e^{-t/2} + c_2 \begin{pmatrix} 1 \\ -1 \end{pmatrix} e^{-2t} - \frac{1}{4} \begin{pmatrix} 17 \\ 15 \end{pmatrix} + \frac{1}{2} \begin{pmatrix} 5 \\ 3 \end{pmatrix} t + \frac{1}{6} \begin{pmatrix} 1 \\ 3 \end{pmatrix} e^t.$$

10. Since the coefficient matrix is *symmetric*, the differential equations can be decoupled.

The eigenvalues and eigenvectors are given by

$$r_1 = -4, \quad \boldsymbol{\xi}^{(1)} = \begin{pmatrix} \sqrt{2} \\ -1 \end{pmatrix} \quad \text{and} \quad r_2 = -1, \quad \boldsymbol{\xi}^{(2)} = \begin{pmatrix} 1 \\ \sqrt{2} \end{pmatrix}.$$

Using the *normalized* eigenvectors as columns, the transformation matrix, and its inverse, are

$$\mathbf{T} = \frac{1}{\sqrt{3}} \begin{pmatrix} \sqrt{2} & 1 \\ -1 & \sqrt{2} \end{pmatrix}, \quad \mathbf{T}^{-1} = \frac{1}{\sqrt{3}} \begin{pmatrix} \sqrt{2} & -1 \\ 1 & \sqrt{2} \end{pmatrix}.$$

Setting  $\mathbf{x} = \mathbf{T}\mathbf{y}$ , and  $\mathbf{h}(t) = \mathbf{T}^{-1}\mathbf{g}(t)$ , the transformed system is given, in scalar form, as

$$\begin{aligned} y_1' &= -4y_1 + \frac{1}{\sqrt{3}}(1 + \sqrt{2})e^{-t} \\ y_2' &= -y_2 + \frac{1}{\sqrt{3}}(1 - \sqrt{2})e^{-t}. \end{aligned}$$

The solutions are easily obtained as

$$\begin{aligned} y_1(t) &= k_1 e^{-4t} + \frac{1}{3\sqrt{3}}(1 + \sqrt{2})e^{-t} \\ y_2(t) &= k_2 e^{-t} + \frac{1}{\sqrt{3}}(1 - \sqrt{2})te^{-t}. \end{aligned}$$

Transforming back to the original variables, the general solution is

$$\mathbf{x} = c_1 \begin{pmatrix} \sqrt{2} \\ -1 \end{pmatrix} e^{-4t} + c_2 \begin{pmatrix} 1 \\ \sqrt{2} \end{pmatrix} e^{-t} + \frac{1}{9} \begin{pmatrix} 2 + \sqrt{2} + 3\sqrt{3} \\ 3\sqrt{6} - \sqrt{2} - 1 \end{pmatrix} e^{-t} + \frac{1}{3} \begin{pmatrix} 1 - \sqrt{2} \\ \sqrt{2} - 2 \end{pmatrix} te^{-t}.$$

Note that

$$\begin{pmatrix} 2 + \sqrt{2} + 3\sqrt{3} \\ 3\sqrt{6} - \sqrt{2} - 1 \end{pmatrix} = \begin{pmatrix} 2 + \sqrt{2} \\ -\sqrt{2} - 1 \end{pmatrix} + 3\sqrt{3} \begin{pmatrix} 1 \\ \sqrt{2} \end{pmatrix}.$$

The *second* vector is an *eigenvector*, hence the solution may be written as

$$\mathbf{x} = c_1 \begin{pmatrix} \sqrt{2} \\ -1 \end{pmatrix} e^{-4t} + c_2 \begin{pmatrix} 1 \\ \sqrt{2} \end{pmatrix} e^{-t} + \frac{1}{9} \begin{pmatrix} 2 + \sqrt{2} \\ -\sqrt{2} - 1 \end{pmatrix} e^{-t} + \frac{1}{3} \begin{pmatrix} 1 - \sqrt{2} \\ \sqrt{2} - 2 \end{pmatrix} te^{-t}.$$

11. Based on the solution of Prob. 3 of Section 7.6, a fundamental matrix is given by

$$\boldsymbol{\Psi}(t) = \begin{pmatrix} 5 \cos t & 5 \sin t \\ 2 \cos t + \sin t & -\cos t + 2 \sin t \end{pmatrix}.$$

The inverse of the fundamental matrix is easily determined as

$$\Psi^{-1}(t) = \frac{1}{5} \begin{pmatrix} \cos t - 2\sin t & 5\sin t \\ 2\cos t + \sin t & -5\cos t \end{pmatrix}.$$

It follows that

$$\Psi^{-1}(t)\mathbf{g}(t) = \begin{pmatrix} \cos t \sin t \\ -\cos^2 t \end{pmatrix},$$

and

$$\int \Psi^{-1}(t)\mathbf{g}(t) dt = \begin{pmatrix} \frac{1}{2}\sin^2 t \\ -\frac{1}{2}\cos t \sin t - \frac{1}{2}t \end{pmatrix}.$$

A particular solution is constructed as

$$\mathbf{v}(t) = \Psi(t) \int \Psi^{-1}(t)\mathbf{g}(t) dt,$$

where

$$\begin{aligned} v_1(t) &= \frac{5}{2}\cos t \sin t - \cos^2 t + \frac{5}{2}t + 1 \\ v_2(t) &= \cos t \sin t - \frac{1}{2}\cos^2 t + t + \frac{1}{2}. \end{aligned}$$

Hence the general solution is

$$\begin{aligned} \mathbf{x} &= c_1 \begin{pmatrix} 5 \cos t \\ 2 \cos t + \sin t \end{pmatrix} + c_2 \begin{pmatrix} 5 \sin t \\ -\cos t + 2 \sin t \end{pmatrix} - \\ &\quad - t \sin t \begin{pmatrix} 5/2 \\ 1 \end{pmatrix} + (t \cos t + \sin t) \begin{pmatrix} 0 \\ 1/2 \end{pmatrix}. \end{aligned}$$

13(a). As shown in Prob. 25 of Section 7.6, the solution of the homogeneous system is

$$\begin{pmatrix} x_1^{(c)} \\ x_2^{(c)} \end{pmatrix} = c_1 e^{-t/2} \begin{pmatrix} \cos(t/2) \\ 4 \sin(t/2) \end{pmatrix} + c_2 e^{-t/2} \begin{pmatrix} \sin(t/2) \\ -4 \cos(t/2) \end{pmatrix}.$$

Therefore the associated fundamental matrix is given by

$$\Psi(t) = e^{-t/2} \begin{pmatrix} \cos(t/2) & \sin(t/2) \\ 4 \sin(t/2) & -4 \cos(t/2) \end{pmatrix}.$$

(b). The inverse of the fundamental matrix is

$$\Psi^{-1}(t) = \frac{e^{t/2}}{4} \begin{pmatrix} 4 \cos(t/2) & \sin(t/2) \\ 4 \sin(t/2) & -\cos(t/2) \end{pmatrix}.$$



It follows that

$$\Psi^{-1}(t)\mathbf{g}(t) = \frac{1}{2} \begin{pmatrix} \cos(t/2) \\ \sin(t/2) \end{pmatrix},$$

and

$$\int \Psi^{-1}(t)\mathbf{g}(t) dt = \begin{pmatrix} \sin(t/2) \\ -\cos(t/2) \end{pmatrix}.$$

A particular solution is constructed as

$$\mathbf{v}(t) = \Psi(t) \int \Psi^{-1}(t)\mathbf{g}(t) dt,$$

where

$$\begin{aligned} v_1(t) &= 0 \\ v_2(t) &= 4e^{-t/2}. \end{aligned}$$

Hence the general solution is

$$\mathbf{x} = c_1 e^{-t/2} \begin{pmatrix} \cos(t/2) \\ 4 \sin(t/2) \end{pmatrix} + c_2 e^{-t/2} \begin{pmatrix} \sin(t/2) \\ -4 \cos(t/2) \end{pmatrix} + 4e^{-t/2} \begin{pmatrix} 0 \\ 1 \end{pmatrix}.$$

Imposing the initial conditions, we require that

$$\begin{aligned} c_1 &= 0 \\ -4c_2 + 4 &= 0, \end{aligned}$$

which results in  $c_1 = 0$  and  $c_2 = 1$ . Therefore the solution of the IVP is

$$\mathbf{x} = e^{-t/2} \begin{pmatrix} \sin(t/2) \\ 4 - 4 \cos(t/2) \end{pmatrix}.$$

15. The general solution of the homogeneous problem is

$$\begin{pmatrix} x_1^{(c)} \\ x_2^{(c)} \end{pmatrix} = c_1 \begin{pmatrix} 1 \\ 2 \end{pmatrix} t^{-1} + c_2 \begin{pmatrix} 2 \\ 1 \end{pmatrix} t^2,$$

which can be verified by substitution into the system of ODEs. Since the vectors are linearly independent, a fundamental matrix is given by

$$\Psi(t) = \begin{pmatrix} t^{-1} & 2t^2 \\ 2t^{-1} & t^2 \end{pmatrix}.$$

The inverse of the fundamental matrix is

$$\Psi^{-1}(t) = \frac{1}{3} \begin{pmatrix} -t & 2t \\ 2t^{-2} & -t^{-2} \end{pmatrix}.$$

Dividing both equations by  $t$ , we obtain

$$\mathbf{g}(t) = \begin{pmatrix} -2 \\ t^3 - t^{-1} \end{pmatrix}.$$

Proceeding with the method of *variation of parameters*,

$$\Psi^{-1}(t)\mathbf{g}(t) = \begin{pmatrix} \frac{2}{3}t^4 + \frac{2}{3}t - \frac{2}{3} \\ -\frac{1}{3}t - \frac{4}{3}t^{-2} + \frac{1}{3}t^{-3} \end{pmatrix},$$

and

$$\int \Psi^{-1}(t)\mathbf{g}(t) dt = \begin{pmatrix} \frac{2}{15}t^5 + \frac{1}{3}t^2 - \frac{2}{3}t \\ -\frac{1}{6}t^2 + \frac{4}{3}t^{-1} - \frac{1}{6}t^{-2} \end{pmatrix}.$$

Hence a particular solution is obtained as

$$\mathbf{v} = \begin{pmatrix} -\frac{1}{5}t^4 + 3t - 1 \\ \frac{1}{10}t^4 + 2t - \frac{3}{2} \end{pmatrix}.$$

The general solution is

$$\mathbf{x} = c_1 \begin{pmatrix} 1 \\ 2 \end{pmatrix} t^{-1} + c_2 \begin{pmatrix} 2 \\ 1 \end{pmatrix} t^2 + \frac{1}{10} \begin{pmatrix} -2 \\ 1 \end{pmatrix} t^4 + \begin{pmatrix} 3 \\ 2 \end{pmatrix} t - \begin{pmatrix} 1 \\ 3/2 \end{pmatrix}.$$

16. Based on the hypotheses,

$$\phi'(t) = \mathbf{P}(t)\phi(t) + \mathbf{g}(t) \quad \text{and} \quad \mathbf{v}'(t) = \mathbf{P}(t)\mathbf{v}(t) + \mathbf{g}(t).$$

Subtracting the two equations results in

$$\phi'(t) - \mathbf{v}'(t) = \mathbf{P}(t)\phi(t) - \mathbf{P}(t)\mathbf{v}(t),$$

that is,

$$[\phi(t) - \mathbf{v}(t)]' = \mathbf{P}(t)[\phi(t) - \mathbf{v}(t)].$$

It follows that  $\phi(t) - \mathbf{v}(t)$  is a solution of the *homogeneous equation*. According to Theorem 7.4.2,

$$\phi(t) - \mathbf{v}(t) = c_1 \mathbf{x}^{(1)}(t) + c_2 \mathbf{x}^{(2)}(t) + \cdots + c_n \mathbf{x}^{(n)}(t).$$

Hence

$$\phi(t) = \mathbf{u}(t) + \mathbf{v}(t),$$

in which  $\mathbf{u}(t)$  is the general solution of the homogeneous problem.

17(a). Setting  $t_0 = 0$  in Eq. (34),

$$\begin{aligned}\mathbf{x} &= \Phi(t)\mathbf{x}^0 + \Phi(t) \int_0^t \Phi^{-1}(s)\mathbf{g}(s)ds \\ &= \Phi(t)\mathbf{x}^0 + \int_0^t \Phi(t)\Phi^{-1}(s)\mathbf{g}(s)ds.\end{aligned}$$

It was shown in Prob. 15(c) in Section 7.7 that  $\Phi(t)\Phi^{-1}(s) = \Phi(t-s)$ . Therefore

$$\mathbf{x} = \Phi(t)\mathbf{x}^0 + \int_0^t \Phi(t-s)\mathbf{g}(s)ds.$$

(b). The *principal* fundamental matrix is identified as  $\Phi(t) = \exp(\mathbf{A}t)$ . Hence

$$\mathbf{x} = \exp(\mathbf{A}t)\mathbf{x}^0 + \int_0^t \exp[\mathbf{A}(t-s)]\mathbf{g}(s)ds.$$

In Prob. 26 of Section 3.7, the particular solution is given as

$$Y(t) = \int_{t_0}^t K(t-s)g(s)ds,$$

in which the kernel  $K(t)$  depends on the nature of the fundamental solutions.

## Chapter Eight

### Section 8.1

2. The Euler formula for this problem is

$$y_{n+1} = y_n + h(5t_n - 3\sqrt{y_n}),$$

in which  $t_n = t_0 + nh$ . Since  $t_0 = 0$ , we can also write

$$y_{n+1} = y_n + 5nh^2 - 3h\sqrt{y_n},$$

with  $y_0 = 2$ .

(a). Euler method with  $h = 0.05$  :

	$n = 2$	$n = 4$	$n = 6$	$n = 8$
$t_n$	0.1	0.2	0.3	0.4
$y_n$	1.59980	1.29288	1.07242	0.930175

(b). Euler method with  $h = 0.025$  :

	$n = 4$	$n = 8$	$n = 12$	$n = 16$
$t_n$	0.1	0.2	0.3	0.4
$y_n$	1.61124	1.31361	1.10012	0.962552

The *backward* Euler formula is

$$y_{n+1} = y_n + h(5t_{n+1} - 3\sqrt{y_{n+1}}),$$

in which  $t_n = t_0 + nh$ . Since  $t_0 = 0$ , we can also write

$$y_{n+1} = y_n + 5(n+1)h^2 - 3h\sqrt{y_{n+1}},$$

with  $y_0 = 2$ . Solving for  $y_{n+1}$ , and choosing the *positive* root, we find that

$$y_{n+1} = \left[ -\frac{3}{2}h + \frac{1}{2}\sqrt{(20n+29)h^2 + 4y_n} \right]^2.$$

(c). Backward Euler method with  $h = 0.05$  :

	$n = 2$	$n = 4$	$n = 6$	$n = 8$
$t_n$	0.1	0.2	0.3	0.4
$y_n$	1.64337	1.37164	1.17763	1.05334

(d). Backward Euler method with  $h = 0.025$  :

	$n = 4$	$n = 8$	$n = 12$	$n = 16$
$t_n$	0.1	0.2	0.3	0.4
$y_n$	1.63301	1.35295	1.15267	1.02407

3. The Euler formula for this problem is

$$y_{n+1} = y_n + h(2y_n - 3t_n),$$

in which  $t_n = t_0 + nh$ . Since  $t_0 = 0$ ,

$$y_{n+1} = y_n + 2hy_n - 3nh^2,$$

with  $y_0 = 1$ .

(a). Euler method with  $h = 0.05$  :

	$n = 2$	$n = 4$	$n = 6$	$n = 8$
$t_n$	0.1	0.2	0.3	0.4
$y_n$	1.2025	1.41603	1.64289	1.88590

(b). Euler method with  $h = 0.025$  :

	$n = 4$	$n = 8$	$n = 12$	$n = 16$
$t_n$	0.1	0.2	0.3	0.4
$y_n$	1.20388	1.41936	1.64896	1.89572

The *backward* Euler formula is

$$y_{n+1} = y_n + h(2y_{n+1} - 3t_{n+1}),$$

in which  $t_n = t_0 + nh$ . Since  $t_0 = 0$ , we can also write

$$y_{n+1} = y_n + 2hy_{n+1} - 3(n+1)h^2,$$

with  $y_0 = 1$ . Solving for  $y_{n+1}$ , we find that

$$y_{n+1} = \frac{y_n - 3(n+1)h^2}{1 - 2h}.$$

(c). Backward Euler method with  $h = 0.05$  :

	$n = 2$	$n = 4$	$n = 6$	$n = 8$
$t_n$	0.1	0.2	0.3	0.4
$y_n$	1.20864	1.43104	1.67042	1.93076

(d). Backward Euler method with  $h = 0.025$  :

	$n = 4$	$n = 8$	$n = 12$	$n = 16$
$t_n$	0.1	0.2	0.3	0.4
$y_n$	1.20693	1.42683	1.66265	1.91802

4. The Euler formula is

$$y_{n+1} = y_n + h[2t_n + \exp(-t_n y_n)].$$

Since  $t_n = t_0 + nh$  and  $t_0 = 0$ , we can also write

$$y_{n+1} = y_n + 2nh^2 + h \exp(-nh y_n),$$

with  $y_0 = 1$ .

(a). Euler method with  $h = 0.05$  :

	$n = 2$	$n = 4$	$n = 6$	$n = 8$
$t_n$	0.1	0.2	0.3	0.4
$y_n$	1.10244	1.21426	1.33484	1.46399

(b). Euler method with  $h = 0.025$  :

	$n = 4$	$n = 8$	$n = 12$	$n = 16$
$t_n$	0.1	0.2	0.3	0.4
$y_n$	1.10365	1.21656	1.33817	1.46832

The *backward* Euler formula is

$$y_{n+1} = y_n + h[2t_{n+1} + \exp(-t_{n+1} y_{n+1})].$$

Since  $t_0 = 0$  and  $t_{n+1} = (n+1)h$ , we can also write

$$y_{n+1} = y_n + 2h^2(n+1) + h \exp[-(n+1)h y_{n+1}],$$

with  $y_0 = 1$ . This equation cannot be solved *explicitly* for  $y_{n+1}$ . At each step, given the current value of  $y_n$ , the equation must be solved *numerically* for  $y_{n+1}$ .

(c). Backward Euler method with  $h = 0.05$  :

	$n = 2$	$n = 4$	$n = 6$	$n = 8$
$t_n$	0.1	0.2	0.3	0.4
$y_n$	1.10720	1.22333	1.34797	1.48110

(d). Backward Euler method with  $h = 0.025$  :

	$n = 4$	$n = 8$	$n = 12$	$n = 16$
$t_n$	0.1	0.2	0.3	0.4
$y_n$	1.10603	1.22110	1.34473	1.47688

6. The Euler formula for this problem is

$$y_{n+1} = y_n + h(t_n^2 - y_n^2) \sin y_n.$$

Here  $t_0 = 0$  and  $t_n = nh$ . So that

$$y_{n+1} = y_n + h(n^2 h^2 - y_n^2) \sin y_n,$$

with  $y_0 = -1$ .

(a). Euler method with  $h = 0.05$  :

	$n = 2$	$n = 4$	$n = 6$	$n = 8$
$t_n$	0.1	0.2	0.3	0.4
$y_n$	-0.920498	-0.857538	-0.808030	-0.770038

(b). Euler method with  $h = 0.025$  :

	$n = 4$	$n = 8$	$n = 12$	$n = 16$
$t_n$	0.1	0.2	0.3	0.4
$y_n$	-0.922575	-0.860923	-0.82300	-0.774965

The *backward* Euler formula is

$$y_{n+1} = y_n + h(t_{n+1}^2 - y_{n+1}^2) \sin y_{n+1}.$$

Since  $t_0 = 0$  and  $t_{n+1} = (n + 1)h$ , we can also write

$$y_{n+1} = y_n + h[(n + 1)^2 h^2 - y_{n+1}^2] \sin y_{n+1},$$

with  $y_0 = -1$ . Note that this equation cannot be solved *explicitly* for  $y_{n+1}$ . Given  $y_n$ , the transcendental equation

$$y_{n+1} + h y_{n+1}^2 \sin y_{n+1} = y_n + h(n + 1)^2 h^2$$

must be solved *numerically* for  $y_{n+1}$ .

(c). Backward Euler method with  $h = 0.05$  :

	$n = 2$	$n = 4$	$n = 6$	$n = 8$
$t_n$	0.1	0.2	0.3	0.4
$y_n$	- 0.928059	- 0.870054	- 0.824021	- 0.788686

(d). Backward Euler method with  $h = 0.025$  :

	$n = 4$	$n = 8$	$n = 12$	$n = 16$
$t_n$	0.1	0.2	0.3	0.4
$y_n$	- 0.926341	- 0.867163	- 0.820279	- 0.784275

8. The Euler formula

$$y_{n+1} = y_n + h(5t_n - 3\sqrt{y_n}),$$

in which  $t_n = t_0 + nh$ . Since  $t_0 = 0$ , we can also write

$$y_{n+1} = y_n + 5nh^2 - 3h\sqrt{y_n},$$

with  $y_0 = 2$ .

(a). Euler method with  $h = 0.025$  :

	$n = 20$	$n = 40$	$n = 60$	$n = 80$
$t_n$	0.5	1.0	1.5	2.0
$y_n$	0.891830	1.25225	2.37818	4.07257



(b). Euler method with  $h = 0.0125$  :

	$n = 40$	$n = 80$	$n = 120$	$n = 160$
$t_n$	0.5	1.0	1.5	2.0
$y_n$	0.908902	1.26872	2.39336	4.08799

The *backward* Euler formula is

$$y_{n+1} = y_n + h(5t_{n+1} - 3\sqrt{y_{n+1}}),$$

in which  $t_n = t_0 + nh$ . Since  $t_0 = 0$ , we can also write

$$y_{n+1} = y_n + 5(n+1)h^2 - 3h\sqrt{y_{n+1}},$$

with  $y_0 = 2$ . Solving for  $y_{n+1}$ , and choosing the *positive* root, we find that

$$y_{n+1} = \left[ -\frac{3}{2}h + \frac{1}{2}\sqrt{(20n+29)h^2 + 4y_n} \right]^2.$$

(c). Backward Euler method with  $h = 0.025$  :

	$n = 20$	$n = 40$	$n = 60$	$n = 80$
$t_n$	0.5	1.0	1.5	2.0
$y_n$	0.958565	1.31786	2.43924	4.13474

(d). Backward Euler method with  $h = 0.0125$  :

	$n = 40$	$n = 80$	$n = 120$	$n = 160$
$t_n$	0.5	1.0	1.5	2.0
$y_n$	0.942261	1.30153	2.24389	4.11908

9. The Euler formula for this problem is

$$y_{n+1} = y_n + h\sqrt{t_n + y_n}.$$

Here  $t_0 = 0$  and  $t_n = nh$ . So that

$$y_{n+1} = y_n + h\sqrt{nh + y_n},$$

with  $y_0 = 3$ .

10. The Euler formula is

$$y_{n+1} = y_n + h[2t_n + \exp(-t_n y_n)].$$

Since  $t_n = t_0 + nh$  and  $t_0 = 0$ , we can also write

$$y_{n+1} = y_n + 2nh^2 + h \exp(-nh y_n),$$

with  $y_0 = 1$ .

(a). Euler method with  $h = 0.025$  :

	$n = 20$	$n = 40$	$n = 60$	$n = 80$
$t_n$	0.5	1.0	1.5	2.0
$y_n$	1.60729	2.46830	3.72167	5.45963

(b). Euler method with  $h = 0.0125$  :

	$n = 40$	$n = 80$	$n = 120$	$n = 160$
$t_n$	0.5	1.0	1.5	2.0
$y_n$	1.60996	2.47460	3.73356	5.47774

The *backward* Euler formula is

$$y_{n+1} = y_n + h[2t_{n+1} + \exp(-t_{n+1} y_{n+1})].$$

Since  $t_0 = 0$  and  $t_{n+1} = (n+1)h$ , we can also write

$$y_{n+1} = y_n + 2h^2(n+1) + h \exp[-(n+1)h y_{n+1}],$$

with  $y_0 = 1$ . This equation cannot be solved *explicitly* for  $y_{n+1}$ . At each step, given the current value of  $y_n$ , the equation must be solved *numerically* for  $y_{n+1}$ .

(c). Backward Euler method with  $h = 0.025$  :

	$n = 20$	$n = 40$	$n = 60$	$n = 80$
$t_n$	0.5	1.0	1.5	2.0
$y_n$	1.61792	2.49356	3.76940	5.53223

(d). Backward Euler method with  $h = 0.0125$  :

	$n = 40$	$n = 80$	$n = 120$	$n = 160$
$t_n$	0.5	1.0	1.5	2.0
$y_n$	1.61528	2.48723	3.75742	5.51404

11. The Euler formula is

$$y_{n+1} = y_n + h(4 - t_n y_n)/(1 + y_n^2).$$

Since  $t_n = t_0 + nh$  and  $t_0 = 0$ , we can also write

$$y_{n+1} = y_n + (4h - nh^2 y_n)/(1 + y_n^2),$$

with  $y_0 = -2$ .

(a). Euler method with  $h = 0.025$  :

	$n = 20$	$n = 40$	$n = 60$	$n = 80$
$t_n$	0.5	1.0	1.5	2.0
$y_n$	-1.45865	-0.217545	1.05715	1.41487

(b). Euler method with  $h = 0.0125$  :

	$n = 40$	$n = 80$	$n = 120$	$n = 160$
$t_n$	0.5	1.0	1.5	2.0
$y_n$	-1.45322	-0.180813	1.05903	1.41244

The *backward* Euler formula is

$$y_{n+1} = y_n + h(4 - t_{n+1} y_{n+1})/(1 + y_{n+1}^2).$$

Since  $t_0 = 0$  and  $t_{n+1} = (n + 1)h$ , we can also write

$$y_{n+1}(1 + y_{n+1}^2) = y_n(1 + y_{n+1}^2) + [4h - (n + 1)h^2 y_{n+1}],$$

with  $y_0 = -2$ . This equation cannot be solved *explicitly* for  $y_{n+1}$ . At each step, given the current value of  $y_n$ , the equation must be solved *numerically* for  $y_{n+1}$ .

(c). Backward Euler method with  $h = 0.025$  :

	$n = 20$	$n = 40$	$n = 60$	$n = 80$
$t_n$	0.5	1.0	1.5	2.0
$y_n$	-1.43600	-0.0681657	1.06489	1.40575

(d). Backward Euler method with  $h = 0.0125$  :

	$n = 40$	$n = 80$	$n = 120$	$n = 160$
$t_n$	0.5	1.0	1.5	2.0
$y_n$	-1.44190	-0.105737	1.06290	1.40789

12. The Euler formula is

$$y_{n+1} = y_n + h(y_n^2 + 2t_n y_n)/(3 + t_n^2).$$

Since  $t_n = t_0 + nh$  and  $t_0 = 0$ , we can also write

$$y_{n+1} = y_n + (h y_n^2 + 2nh^2 y_n)/(3 + n^2 h^2),$$

with  $y_0 = 0.5$ .

(a). Euler method with  $h = 0.025$  :

	$n = 20$	$n = 40$	$n = 60$	$n = 80$
$t_n$	0.5	1.0	1.5	2.0
$y_n$	0.587987	0.791589	1.14743	1.70973

(b). Euler method with  $h = 0.0125$  :

	$n = 40$	$n = 80$	$n = 120$	$n = 160$
$t_n$	0.5	1.0	1.5	2.0
$y_n$	0.589440	0.795758	1.15693	1.72955

The *backward* Euler formula is

$$y_{n+1} = y_n + h(y_{n+1}^2 + 2t_{n+1} y_{n+1})/(3 + t_{n+1}^2).$$

Since  $t_0 = 0$  and  $t_{n+1} = (n + 1)h$ , we can also write

$$y_{n+1} [3 + (n + 1)^2 h^2] - h y_{n+1}^2 = y_n [3 + (n + 1)^2 h^2] + 2(n + 1)h^2 y_{n+1},$$

with  $y_0 = 0.5$ . Note that although this equation can be solved *explicitly* for  $y_{n+1}$ , it is also possible to use a numerical equation solver. At each time step, given the current

value of  $y_n$ , the equation may be solved *numerically* for  $y_{n+1}$ .

(c). Backward Euler method with  $h = 0.025$  :

	$n = 20$	$n = 40$	$n = 60$	$n = 80$
$t_n$	0.5	1.0	1.5	2.0
$y_n$	0.593901	0.808716	1.18687	1.79291

(d). Backward Euler method with  $h = 0.0125$  :

	$n = 40$	$n = 80$	$n = 120$	$n = 160$
$t_n$	0.5	1.0	1.5	2.0
$y_n$	0.592396	0.804319	1.17664	1.77111

13. The Euler formula for this problem is

$$y_{n+1} = y_n + h(1 - t_n + 4y_n),$$

in which  $t_n = t_0 + nh$ . Since  $t_0 = 0$ , we can also write

$$y_{n+1} = y_n + h - nh^2 + 4hy_n,$$

with  $y_0 = 1$ . With  $h = 0.01$ , a total number of 200 iterations is needed to reach  $\bar{t} = 2$ . With  $h = 0.001$ , a total of 2000 iterations are necessary.

14. The *backward* Euler formula is

$$y_{n+1} = y_n + h(1 - t_{n+1} + 4y_{n+1}).$$

Since the equation is linear, we can solve for  $y_{n+1}$  in terms of  $y_n$  :

$$y_{n+1} = \frac{y_n + h - h t_{n+1}}{1 - 4h}.$$

Here  $t_0 = 0$  and  $y_0 = 1$ . With  $h = 0.01$ , a total number of 200 iterations is needed to reach  $\bar{t} = 2$ . With  $h = 0.001$ , a total of 2000 iterations are necessary.

18. Let  $\phi(t)$  be a solution of the initial value problem. The *local* truncation error for the Euler method, on the interval  $t_n \leq t \leq t_{n+1}$ , is given by

$$e_{n+1} = \frac{1}{2} \phi''(\bar{t}_n) h^2,$$

where  $t_n < \bar{t}_n < t_{n+1}$ . Since  $\phi'(t) = t^2 + [\phi(t)]^2$ , it follows that

$$\begin{aligned} \phi''(t) &= 2t + 2\phi(t)\phi'(t) \\ &= 2t + 2t^2\phi(t) + 2[\phi(t)]^3. \end{aligned}$$

Hence

$$|e_{n+1}| \leq [t_{n+1} + t_{n+1}^2 M_{n+1} + M_{n+1}^3] h^2,$$

in which  $M_{n+1} = \max\{\phi(t) \mid t_n \leq t \leq t_{n+1}\}$ .

20. Given that  $\phi(t)$  is a solution of the initial value problem, the *local* truncation error for the Euler method, on the interval  $t_n \leq t \leq t_{n+1}$ , is

$$e_{n+1} = \frac{1}{2} \phi''(\bar{t}_n) h^2,$$

where  $t_n < \bar{t}_n < t_{n+1}$ . Based on the ODE,  $\phi'(t) = \sqrt{t + \phi(t)}$ , and hence

$$\begin{aligned} \phi''(t) &= \frac{1 + \phi'(t)}{2\sqrt{t + \phi(t)}} \\ &= \frac{1}{2\sqrt{t + \phi(t)}} + \frac{1}{2}. \end{aligned}$$

Therefore

$$|e_{n+1}| \leq \frac{1}{4} \left[ 1 + \frac{1}{\sqrt{\bar{t}_n + \phi(\bar{t}_n)}} \right] h^2.$$

21. Let  $\phi(t)$  be a solution of the initial value problem. The *local* truncation error for the Euler method, on the interval  $t_n \leq t \leq t_{n+1}$ , is given by

$$e_{n+1} = \frac{1}{2} \phi''(\bar{t}_n) h^2,$$

where  $t_n < \bar{t}_n < t_{n+1}$ . Since  $\phi'(t) = 2t + \exp[-t\phi(t)]$ , it follows that

$$\begin{aligned} \phi''(t) &= 2 - 2[\phi(t) + t\phi'(t)] \cdot \exp[-t\phi(t)] \\ &= 2 - \{\phi(t) + 2t^2 + t\exp[-t\phi(t)]\} \cdot \exp[-t\phi(t)]. \end{aligned}$$

Hence

$$e_{n+1} = h^2 - \frac{h^2}{2} \left\{ \phi(\bar{t}_n) + 2\bar{t}_n^2 + \bar{t}_n \exp[-\bar{t}_n \phi(\bar{t}_n)] \right\} \cdot \exp[-\bar{t}_n \phi(\bar{t}_n)].$$

22(a). Direct integration yields  $\phi(t) = \frac{1}{5\pi} \sin 5\pi t + 1$ .

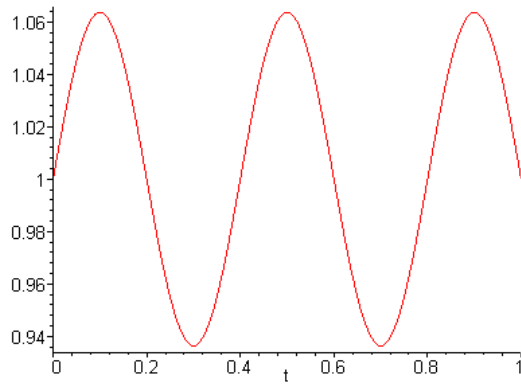

(b).

	$n = 0$	$n = 1$	$n = 2$	$n = 3$
$t_n$	0.0	0.2	0.4	0.6
$y_n$	1.0	1.2	1.0	1.2

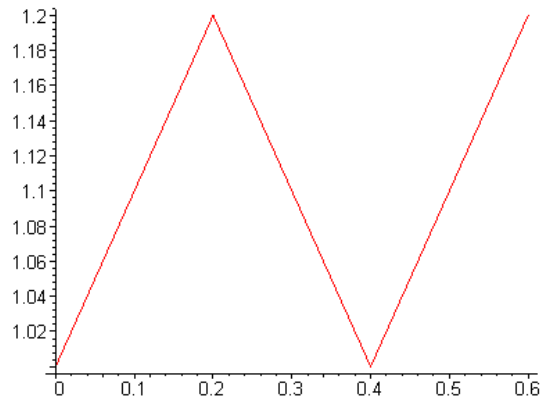

(c).

	$n = 0$	$n = 2$	$n = 4$	$n = 6$
$t_n$	0.0	0.2	0.4	0.6
$y_n$	1.0	1.1	1.0	1.1

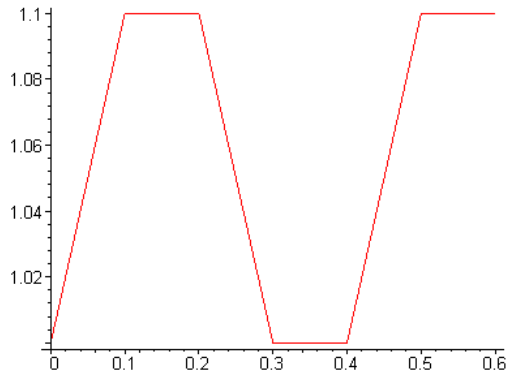

(d). Since  $\phi''(t) = -5\pi \sin 5\pi t$ , the *local* truncation error for the Euler method, on the interval  $t_n \leq t \leq t_{n+1}$ , is given by

$$e_{n+1} = -\frac{5\pi h^2}{2} \sin 5\pi \bar{t}_n.$$

In order to satisfy

$$|e_{n+1}| \leq \frac{5\pi h^2}{2} < 0.05,$$

it is necessary that

$$h < \frac{1}{\sqrt{50\pi}} \approx 0.08.$$

25(a). The Euler formula is

$$y_{n+1} = y_n + h(1 - t_n + 4y_n).$$

	$n = 2$	$n = 4$	$n = 6$	$n = 8$
$t_n$	0.1	0.2	0.3	0.4
$y_n$	1.55	2.34	3.46	5.07

(b). The Euler formula for this problem is

$$y_{n+1} = y_n + h(3 + t_n - y_n).$$

	$n = 2$	$n = 4$	$n = 6$	$n = 8$
$t_n$	0.1	0.2	0.3	0.4
$y_n$	1.20	1.39	1.57	1.74

(c). The Euler formula is



$$y_{n+1} = y_n + h(2y_n - 3t_n).$$

	$n = 2$	$n = 4$	$n = 6$	$n = 8$
$t_n$	0.1	0.2	0.3	0.4
$y_n$	1.20	1.42	1.65	1.90

26(a).

$$1000 \cdot \begin{vmatrix} 6.0 & 18 \\ 2.0 & 6.0 \end{vmatrix} = 1000 \cdot (0) = 0.$$

(b).

$$1000 \cdot \begin{vmatrix} 6.01 & 18.0 \\ 2.00 & 6.00 \end{vmatrix} = 1000(0.06) = 60.$$

(c).

$$1000 \cdot \begin{vmatrix} 6.010 & 18.04 \\ 2.004 & 6.000 \end{vmatrix} = 1000(-0.09216) = -92.16.$$

27. Rounding to *three* digits,  $a(b - c) \approx 0.224$ . Likewise, to *three* digits,  $ab \approx 0.702$  and  $ac \approx 0.477$ . It follows that  $ab - ac \approx 0.225$ .

### Section 8.2

1. The improved Euler formula for this problem is

$$y_{n+1} = y_n + h \left( 3 + \frac{1}{2}t_n + \frac{1}{2}t_{n+1} - y_n \right) - \frac{h^2}{2}(3 + t_n - y_n).$$

Since  $t_n = t_0 + nh$  and  $t_0 = 0$ , we can also write

$$y_{n+1} = y_n + h(3 - y_n) + \frac{h^2}{2}(y_n - 2 + 2n) - \frac{nh^3}{2},$$

with  $y_0 = 1$ .

(a).  $h = 0.05$  :

	$n = 2$	$n = 4$	$n = 6$	$n = 8$
$t_n$	0.1	0.2	0.3	0.4
$y_n$	1.19512	1.38120	1.55909	1.72956

(b).  $h = 0.025$  :

	$n = 4$	$n = 8$	$n = 12$	$n = 16$
$t_n$	0.1	0.2	0.3	0.4
$y_n$	1.19515	1.38125	1.55916	1.72965

(c).  $h = 0.0125$  :

	$n = 8$	$n = 16$	$n = 24$	$n = 32$
$t_n$	0.1	0.2	0.3	0.4
$y_n$	1.19516	1.38126	1.55918	1.72967

2. The improved Euler formula is

$$y_{n+1} = y_n + \frac{h}{2}(5t_n - 3\sqrt{y_n}) + \frac{h}{2}(5t_{n+1} - 3\sqrt{K_n}),$$

in which  $K_n = y_n + h(5t_n - 3\sqrt{y_n})$ . Since  $t_n = t_0 + nh$  and  $t_0 = 0$ , we can also write

$$y_{n+1} = y_n + \frac{h}{2}(5nh - 3\sqrt{y_n}) + \frac{h}{2}[5(n+1)h - 3\sqrt{K_n}],$$

with  $y_0 = 2$ .

(a).  $h = 0.05$  :

	$n = 2$	$n = 4$	$n = 6$	$n = 8$
$t_n$	0.1	0.2	0.3	0.4
$y_n$	1.62283	1.33460	1.12820	0.995445

(b).  $h = 0.025$  :

	$n = 4$	$n = 8$	$n = 12$	$n = 16$
$t_n$	0.1	0.2	0.3	0.4
$y_n$	1.62243	1.33386	1.12718	0.994215

(c).  $h = 0.0125$  :

	$n = 8$	$n = 16$	$n = 24$	$n = 32$
$t_n$	0.1	0.2	0.3	0.4
$y_n$	1.62234	1.33368	1.12693	0.993921

3. The improved Euler formula for this problem is

$$y_{n+1} = y_n + \frac{h}{2}(4y_n - 3t_n - 3t_{n+1}) + h^2(2y_n - 3t_n).$$

Since  $t_n = t_0 + nh$  and  $t_0 = 0$ , we can also write

$$y_{n+1} = y_n + 2h y_n + \frac{h^2}{2}(4y_n - 3 - 6n) - 3nh^3,$$

with  $y_0 = 1$ .

(a).  $h = 0.05$  :

	$n = 2$	$n = 4$	$n = 6$	$n = 8$
$t_n$	0.1	0.2	0.3	0.4
$y_n$	1.20526	1.42273	1.65511	1.90570

(b).  $h = 0.025$  :

	$n = 4$	$n = 8$	$n = 12$	$n = 16$
$t_n$	0.1	0.2	0.3	0.4
$y_n$	1.20533	1.42290	1.65542	1.90621

(c).  $h = 0.0125$  :

	$n = 8$	$n = 16$	$n = 24$	$n = 32$
$t_n$	0.1	0.2	0.3	0.4
$y_n$	1.20534	1.42294	1.65550	1.90634

5. The improved Euler formula is

$$y_{n+1} = y_n + h \frac{y_n^2 + 2t_n y_n}{2(3 + t_n^2)} + h \frac{K_n^2 + 2t_{n+1}K_n}{2(3 + t_{n+1}^2)},$$

in which

$$K_n = y_n + h \frac{y_n^2 + 2t_n y_n}{3 + t_n^2}.$$

Since  $t_n = t_0 + nh$  and  $t_0 = 0$ , we can also write

$$y_{n+1} = y_n + h \frac{y_n^2 + 2nh y_n}{2(3 + n^2h^2)} + h \frac{K_n^2 + 2(n+1)hK_n}{2[3 + (n+1)^2h^2]},$$

with  $y_0 = 0.5$ .

(a).  $h = 0.05$  :

	$n = 2$	$n = 4$	$n = 6$	$n = 8$
$t_n$	0.1	0.2	0.3	0.4
$y_n$	0.510164	0.524126	0.54083	0.564251

(b).  $h = 0.025$  :

	$n = 4$	$n = 8$	$n = 12$	$n = 16$
$t_n$	0.1	0.2	0.3	0.4
$y_n$	0.510168	0.524135	0.542100	0.564277

(c).  $h = 0.0125$  :

	$n = 8$	$n = 16$	$n = 24$	$n = 32$
$t_n$	0.1	0.2	0.3	0.4
$y_n$	0.51069	0.524137	0.542104	0.564284

6. The improved Euler formula for this problem is

$$y_{n+1} = y_n + \frac{h}{2}(t_n^2 - y_n^2)\sin y_n + \frac{h}{2}(t_{n+1}^2 - K_n^2)\sin K_n,$$

in which

$$K_n = y_n + h (t_n^2 - y_n^2) \sin y_n .$$

Since  $t_n = t_0 + nh$  and  $t_0 = 0$ , we can also write

$$y_{n+1} = y_n + \frac{h}{2} (n^2 h^2 - y_n^2) \sin y_n + \frac{h}{2} [(n+1)^2 h^2 - K_n^2] \sin K_n,$$

with  $y_0 = -1$ .

(a).  $h = 0.05$  :

	$n = 2$	$n = 4$	$n = 6$	$n = 8$
$t_n$	0.1	0.2	0.3	0.4
$y_n$	- 0.924650	- 0.864338	- 0.816642	- 0.780008

(b).  $h = 0.025$  :

	$n = 4$	$n = 8$	$n = 12$	$n = 16$
$t_n$	0.1	0.2	0.3	0.4
$y_n$	- 0.924550	- 0.864177	- 0.816442	- 0.779781

(c).  $h = 0.0125$  :

	$n = 8$	$n = 16$	$n = 24$	$n = 32$
$t_n$	0.1	0.2	0.3	0.4
$y_n$	- 0.924525	- 0.864138	- 0.816393	- 0.779725

7. The improved Euler formula for this problem is

$$y_{n+1} = y_n + \frac{h}{2} (4 y_n - t_n - t_{n+1} + 1) + h^2 (2 y_n - t_n + 0.5).$$

Since  $t_n = t_0 + nh$  and  $t_0 = 0$ , we can also write

$$y_{n+1} = y_n + h(2 y_n + 0.5) + h^2(2 y_n - n) - nh^3 ,$$

with  $y_0 = 1$ .

(a).  $h = 0.025$  :

	$n = 20$	$n = 40$	$n = 60$	$n = 80$
$t_n$	0.5	1.0	1.5	2.0
$y_n$	2.96719	7.88313	20.8114	55.5106

(b).  $h = 0.0125$  :

	$n = 40$	$n = 80$	$n = 120$	$n = 160$
$t_n$	0.5	1.0	1.5	2.0
$y_n$	2.96800	7.88755	20.8294	55.5758

8. The improved Euler formula is

$$y_{n+1} = y_n + \frac{h}{2}(5t_n - 3\sqrt{y_n}) + \frac{h}{2}(5t_{n+1} - 3\sqrt{K_n}),$$

in which  $K_n = y_n + h(5t_n - 3\sqrt{y_n})$ . Since  $t_n = t_0 + nh$  and  $t_0 = 0$ , we can also write

$$y_{n+1} = y_n + \frac{h}{2}(5nh - 3\sqrt{y_n}) + \frac{h}{2}[5(n+1)h - 3\sqrt{K_n}],$$

with  $y_0 = 2$ .

(a).  $h = 0.025$  :

	$n = 20$	$n = 40$	$n = 60$	$n = 80$
$t_n$	0.5	1.0	1.5	2.0
$y_n$	0.926139	1.28558	2.40898	4.10386

(b).  $h = 0.0125$  :

	$n = 40$	$n = 80$	$n = 120$	$n = 160$
$t_n$	0.5	1.0	1.5	2.0
$y_n$	0.925815	1.28525	2.40869	4.10359

9. The improved Euler formula for this problem is

$$y_{n+1} = y_n + \frac{h}{2}\sqrt{t_n + y_n} + \frac{h}{2}\sqrt{t_{n+1} + K_n},$$

in which  $K_n = y_n + h\sqrt{t_n + y_n}$ . Since  $t_n = t_0 + nh$  and  $t_0 = 0$ , we can also write

$$y_{n+1} = y_n + \frac{h}{2}\sqrt{nh + y_n} + \frac{h}{2}\sqrt{(n+1)h + K_n},$$

with  $y_0 = 3$ .

(a).  $h = 0.025$  :

	$n = 20$	$n = 40$	$n = 60$	$n = 80$
$t_n$	0.5	1.0	1.5	2.0
$y_n$	3.96217	5.10887	6.43134	7.92332

(b).  $h = 0.0125$  :

	$n = 40$	$n = 80$	$n = 120$	$n = 160$
$t_n$	0.5	1.0	1.5	2.0
$y_n$	3.96218	5.10889	6.43138	7.92337

10. The improved Euler formula is

$$y_{n+1} = y_n + \frac{h}{2}[2t_n + \exp(-t_n y_n)] + \frac{h}{2}[2t_{n+1} + \exp(-t_{n+1} K_n)],$$

in which  $K_n = y_n + h[2t_n + \exp(-t_n y_n)]$ . Since  $t_n = t_0 + nh$  and  $t_0 = 0$ , we can also write

$$y_{n+1} = y_n + \frac{h}{2}[2nh + \exp(-nh y_n)] + \frac{h}{2}\{2(n+1)h + \exp[-(n+1)h K_n]\},$$

with  $y_0 = 1$ .

(a).  $h = 0.025$  :

	$n = 20$	$n = 40$	$n = 60$	$n = 80$
$t_n$	0.5	1.0	1.5	2.0
$y_n$	1.61263	2.48097	3.74556	5.49595

(b).  $h = 0.0125$  :

	$n = 40$	$n = 80$	$n = 120$	$n = 160$
$t_n$	0.5	1.0	1.5	2.0
$y_n$	1.61263	2.48092	3.74550	5.49589

12. The improved Euler formula is

$$y_{n+1} = y_n + h \frac{y_n^2 + 2t_n y_n}{2(3 + t_n^2)} + h \frac{K_n^2 + 2t_{n+1} K_n}{2(3 + t_{n+1}^2)},$$

in which

$$K_n = y_n + h \frac{y_n^2 + 2t_n y_n}{3 + t_n^2}.$$

Since  $t_n = t_0 + nh$  and  $t_0 = 0$ , we can also write

$$y_{n+1} = y_n + h \frac{y_n^2 + 2nh y_n}{2(3 + n^2 h^2)} + h \frac{K_n^2 + 2(n+1)hK_n}{2[3 + (n+1)^2 h^2]},$$

with  $y_0 = 0.5$ .

(a).  $h = 0.025$  :

	$n = 20$	$n = 40$	$n = 60$	$n = 80$
$t_n$	0.5	1.0	1.5	2.0
$y_n$	0.590897	0.799950	1.16653	1.74969

(b).  $h = 0.0125$  :

	$n = 40$	$n = 80$	$n = 120$	$n = 160$
$t_n$	0.5	1.0	1.5	2.0
$y_n$	0.590906	0.799988	1.16663	1.74992

16. The exact solution of the initial value problem is  $\phi(t) = \frac{1}{2} + \frac{1}{2}e^{2t}$ . Based on the result in Prob. 14(c), the local truncation error for a *linear* differential equation is

$$e_{n+1} = \frac{1}{6} \phi'''(\bar{t}_n) h^3,$$

where  $t_n < \bar{t}_n < t_{n+1}$ . Since  $\phi'''(t) = 4e^{2t}$ , the local truncation error is

$$e_{n+1} = \frac{2}{3} \exp(2\bar{t}_n) h^3.$$

Furthermore, with  $0 \leq \bar{t}_n \leq 1$ ,

$$|e_{n+1}| \leq \frac{2}{3} e^2 h^3.$$

It also follows that for  $h = 0.1$ ,

$$|e_1| \leq \frac{2}{3} e^{0.2} (0.1)^3 = \frac{1}{1500} e^{0.2}.$$

Using the improved Euler method, with  $h = 0.1$ , we have  $y_1 \approx 1.11000$ . The exact value is given by  $\phi(0.1) = 1.1107014$ .

17. The exact solution of the initial value problem is given by  $\phi(t) = \frac{1}{2}t + e^{2t}$ . Using the modified Euler method, the local truncation error for a *linear* differential equation is

$$e_{n+1} = \frac{1}{6} \phi'''(\bar{t}_n) h^3,$$



where  $t_n < \bar{t}_n < t_{n+1}$ . Since  $\phi'''(t) = 8e^{2t}$ , the local truncation error is

$$e_{n+1} = \frac{4}{3} \exp(2\bar{t}_n) h^3.$$

Furthermore, with  $0 \leq \bar{t}_n \leq 1$ , the *local* error is bounded by

$$|e_{n+1}| \leq \frac{4}{3} e^2 h^3.$$

It also follows that for  $h = 0.1$ ,

$$|e_1| \leq \frac{4}{3} e^{0.2} (0.1)^3 = \frac{1}{750} e^{0.2}.$$

Using the improved Euler method, with  $h = 0.1$ , we have  $y_1 \approx 1.27000$ . The exact value is given by  $\phi(0.1) = 1.271403$ .

18. Using the *Euler method*,

$$\begin{aligned} y_1 &= 1 + 0.1(0.5 - 0 + 2 \cdot 1) \\ &= 1.25. \end{aligned}$$

Using the *improved Euler method*,

$$\begin{aligned} y_1 &= 1 + 0.05(0.5 - 0 + 2 \cdot 1) + 0.05(0.5 - 0.1 + 2 \cdot 1.25) \\ &= 1.27. \end{aligned}$$

The estimated error is  $e_1 \approx 1.27 - 1.25 = 0.02$ . The step size should be adjusted by a factor of  $\sqrt{0.0025/0.02} \approx 0.354$ . Hence the required step size is estimated as

$$h \approx (0.1)(0.36) = 0.036.$$

20. Using the *Euler method*,

$$\begin{aligned} y_1 &= 3 + 0.1\sqrt{0+3} \\ &= 3.173205. \end{aligned}$$

Using the *improved Euler method*,

$$\begin{aligned} y_1 &= 3 + 0.05\sqrt{0+3} + 0.05\sqrt{0.1+3.173205} \\ &= 3.177063. \end{aligned}$$

The estimated error is  $e_1 \approx 3.177063 - 3.173205 = 0.003858$ . The step size should be adjusted by a factor of  $\sqrt{0.0025/0.003858} \approx 0.805$ . Hence the required step size is estimated as

$$h \approx (0.1)(0.805) = 0.0805.$$

21. Using the *Euler method*,

$$\begin{aligned} y_1 &= 0.5 + 0.1 \frac{(0.5)^2 + 0}{3 + 0} \\ &= 0.508334 \end{aligned}$$

Using the *improved Euler method*,

$$\begin{aligned} y_1 &= 0.5 + 0.05 \frac{(0.5)^2 + 0}{3 + 0} + 0.05 \frac{(0.508334)^2 + 2(0.1)(0.508334)}{3 + (0.1)^2} \\ &= 0.510148. \end{aligned}$$

The estimated error is  $e_1 \approx 0.510148 - 0.508334 = 0.0018$ . The local truncation error is *less than the given tolerance*. The step size can be adjusted by a factor of  $\sqrt{0.0025/0.0018} \approx 1.1785$ . Hence it is possible to use a step size of

$$h \approx (0.1)(1.1785) \approx 0.117.$$

22. Assuming that the solution has continuous derivatives at least to the third order,

$$\phi(t_{n+1}) = \phi(t_n) + \phi'(t_n)h + \frac{\phi''(t_n)}{2!}h^2 + \frac{\phi'''(\bar{t}_n)}{3!}h^3,$$

where  $t_n < \bar{t}_n < t_{n+1}$ . Suppose that  $y_n = \phi(t_n)$ .

(a). The local truncation error is given by

$$e_{n+1} = \phi(t_{n+1}) - y_{n+1}.$$

The *modified Euler formula* is defined as

$$y_{n+1} = y_n + h f \left[ t_n + \frac{1}{2}h, y_n + \frac{1}{2}h f(t_n, y_n) \right].$$

Observe that  $\phi'(t_n) = f(t_n, \phi(t_n)) = f(t_n, y_n)$ . It follows that

$$\begin{aligned} e_{n+1} &= \phi(t_{n+1}) - y_{n+1} \\ &= h f(t_n, y_n) + \frac{\phi''(t_n)}{2!} h^2 + \frac{\phi'''(\bar{t}_n)}{3!} h^3 - \\ &\quad - h f \left[ t_n + \frac{1}{2}h, y_n + \frac{1}{2}h f(t_n, y_n) \right]. \end{aligned}$$

(b). As shown in Prob. 14(b),

$$\phi''(t_n) = f_t(t_n, y_n) + f_y(t_n, y_n) f(t_n, y_n).$$

Furthermore,

$$\begin{aligned} f \left[ t_n + \frac{1}{2}h, y_n + \frac{1}{2}h f(t_n, y_n) \right] &= f(t_n, y_n) + f_t(t_n, y_n) \frac{h}{2} + f_y(t_n, y_n) k + \\ &\quad + \frac{1}{2!} \left[ \frac{h^2}{4} f_{tt} + h k f_{ty} + k^2 f_{yy} \right]_{t=\xi, y=\eta}, \end{aligned}$$

in which  $k = \frac{1}{2}h f(t_n, y_n)$  and  $t_n < \xi < t_n + h/2$ ,  $y_n < \eta < y_n + k$ . Therefore

$$e_{n+1} = \frac{\phi'''(\bar{t}_n)}{3!} h^3 - \frac{h}{2!} \left[ \frac{h^2}{4} f_{tt} + h k f_{ty} + k^2 f_{yy} \right]_{t=\xi, y=\eta}.$$

Note that each term in the brackets has a factor of  $h^2$ . Hence the local truncation error is *proportional to*  $h^3$ .

(c). If  $f(t, y)$  is linear, then  $f_{tt} = f_{ty} = f_{yy} = 0$ , and

$$e_{n+1} = \frac{\phi'''(\bar{t}_n)}{3!} h^3.$$

23. The *modified* Euler formula for this problem is

$$\begin{aligned} y_{n+1} &= y_n + h \left\{ 3 + t_n + \frac{1}{2}h - \left[ y_n + \frac{1}{2}h(3 + t_n - y_n) \right] \right\} \\ &= y_n + h(3 + t_n - y_n) + \frac{h^2}{2}(y_n - t_n - 2). \end{aligned}$$

Since  $t_n = t_0 + nh$  and  $t_0 = 0$ , we can also write

$$y_{n+1} = y_n + h(3 + nh - y_n) + \frac{h^2}{2}(y_n - nh - 2),$$

with  $y_0 = 1$ . Setting  $h = 0.1$ , we obtain the following values :

	$n = 1$	$n = 2$	$n = 3$	$n = 4$
$t_n$	0.1	0.2	0.3	0.4
$y_n$	1.19500	1.38098	1.55878	1.72920

25. The *modified* Euler formula is

$$\begin{aligned}
 y_{n+1} &= y_n + h \left[ 2y_n - 3t_n - \frac{3}{2}h + h(2y_n - 3t_n) \right] \\
 &= y_n + h(2y_n - 3t_n) + \frac{h^2}{2}(4y_n - 6t_n - 3).
 \end{aligned}$$

Since  $t_n = t_0 + nh$  and  $t_0 = 0$ , we can also write

$$y_{n+1} = y_n + h(2y_n - 3nh) + \frac{h^2}{2}(4y_n - 6nh - 3),$$

with  $y_0 = 1$ . Setting  $h = 0.1$ , we obtain :

	$n = 1$	$n = 2$	$n = 3$	$n = 4$
$t_n$	0.1	0.2	0.3	0.4
$y_n$	1.20500	1.42210	1.65396	1.90383

26. The *modified* Euler formula for this problem is

$$y_{n+1} = y_n + h \left\{ 2t_n + h + \exp \left[ - \left( t_n + \frac{h}{2} \right) K_n \right] \right\},$$

in which  $K_n = y_n + \frac{h}{2}[2t_n + \exp(-t_n y_n)]$ . Now  $t_n = t_0 + nh$ , with  $t_0 = 0$  and  $y_0 = 1$ . Setting  $h = 0.1$ , we obtain the following values :

	$n = 1$	$n = 2$	$n = 3$	$n = 4$
$t_n$	0.1	0.2	0.3	0.4
$y_n$	1.104885	1.21892	1.34157	1.472724

27. Let  $f(t, y)$  be *linear* in both variables. The *improved* Euler formula is

$$\begin{aligned} y_{n+1} &= y_n + \frac{1}{2}h[f(t_n, y_n) + f(t_n + h, y_n + hf(t_n, y_n))] \\ &= y_n + \frac{1}{2}hf(t_n, y_n) + \frac{1}{2}hf(t_n, y_n) + \frac{1}{2}hf[h, hf(t_n, y_n)] \\ &= hf(h, y_n) + \frac{1}{2}hf[h, hf(t_n, y_n)]. \end{aligned}$$

The *modified* Euler formula is

$$\begin{aligned} y_{n+1} &= y_n + hf\left[t_n + \frac{1}{2}h, y_n + \frac{1}{2}hf(t_n, y_n)\right] \\ &= y_n + hf(t_n, y_n) + hf\left[\frac{1}{2}h, \frac{1}{2}hf(t_n, y_n)\right]. \end{aligned}$$

Since  $f(t, y)$  is *linear* in both variables,

$$f\left[\frac{1}{2}h, \frac{1}{2}hf(t_n, y_n)\right] = \frac{1}{2}f[h, hf(t_n, y_n)].$$

## Section 8.3

1. The ODE is linear, with  $f(t, y) = 3 + t - y$ . The Runge-Kutta algorithm requires the evaluations

$$\begin{aligned}k_{n1} &= f(t_n, y_n) \\k_{n2} &= f\left(t_n + \frac{1}{2}h, y_n + \frac{1}{2}hk_{n1}\right) \\k_{n3} &= f\left(t_n + \frac{1}{2}h, y_n + \frac{1}{2}hk_{n2}\right) \\k_{n4} &= f(t_n + h, y_n + hk_{n3}).\end{aligned}$$

The next estimate is given as the weighted average

$$y_{n+1} = y_n + \frac{h}{6}(k_{n1} + 2k_{n2} + 2k_{n3} + k_{n4}).$$

(a). For  $h = 0.1$  :

	$n = 1$	$n = 2$	$n = 3$	$n = 4$
$t_n$	0.1	0.2	0.3	0.4
$y_n$	1.19516	1.38127	1.55918	1.72968

(b). For  $h = 0.05$  :

	$n = 2$	$n = 4$	$n = 6$	$n = 8$
$t_n$	0.1	0.2	0.3	0.4
$y_n$	1.19516	1.38127	1.55918	1.72968

The exact solution of the IVP is  $y(t) = 2 + t - e^{-t}$ .

2. In this problem,  $f(t, y) = 5t - 3\sqrt{y}$ . At each time step, the Runge-Kutta algorithm requires the evaluations

$$\begin{aligned}k_{n1} &= f(t_n, y_n) \\k_{n2} &= f\left(t_n + \frac{1}{2}h, y_n + \frac{1}{2}hk_{n1}\right) \\k_{n3} &= f\left(t_n + \frac{1}{2}h, y_n + \frac{1}{2}hk_{n2}\right) \\k_{n4} &= f(t_n + h, y_n + hk_{n3}).\end{aligned}$$

The next estimate is given as the weighted average

$$y_{n+1} = y_n + \frac{h}{6}(k_{n1} + 2k_{n2} + 2k_{n3} + k_{n4}).$$

(a). For  $h = 0.1$  :

	$n = 1$	$n = 2$	$n = 3$	$n = 4$
$t_n$	0.1	0.2	0.3	0.4
$y_n$	1.62231	1.33362	1.12686	0.993839

(b). For  $h = 0.05$  :

	$n = 2$	$n = 4$	$n = 6$	$n = 8$
$t_n$	0.1	0.2	0.3	0.4
$y_n$	1.62230	1.33362	1.12685	0.993826

The exact solution of the IVP is given *implicitly* as

$$\frac{1}{(2\sqrt{y} + 5t)^5 (t - \sqrt{y})^2} = \frac{\sqrt{2}}{512}.$$

3. The ODE is linear, with  $f(t, y) = 2y - 3t$ . The Runge-Kutta algorithm requires the evaluations

$$\begin{aligned} k_{n1} &= f(t_n, y_n) \\ k_{n2} &= f\left(t_n + \frac{1}{2}h, y_n + \frac{1}{2}hk_{n1}\right) \\ k_{n3} &= f\left(t_n + \frac{1}{2}h, y_n + \frac{1}{2}hk_{n2}\right) \\ k_{n4} &= f(t_n + h, y_n + hk_{n3}). \end{aligned}$$

The next estimate is given as the weighted average

$$y_{n+1} = y_n + \frac{h}{6}(k_{n1} + 2k_{n2} + 2k_{n3} + k_{n4}).$$

(a). For  $h = 0.1$  :

	$n = 1$	$n = 2$	$n = 3$	$n = 4$
$t_n$	0.1	0.2	0.3	0.4
$y_n$	1.20535	1.42295	1.65553	1.90638

(b). For  $h = 0.05$  :

	$n = 2$	$n = 4$	$n = 6$	$n = 8$
$t_n$	0.1	0.2	0.3	0.4
$y_n$	1.20535	1.42296	1.65553	1.90638

The exact solution of the IVP is  $y(t) = e^{2t}/4 + 3t/2 + 3/4$ .

5. In this problem,  $f(t, y) = (y^2 + 2ty)/(3 + t^2)$ . The Runge-Kutta algorithm

requires the evaluations

$$\begin{aligned}
 k_{n1} &= f(t_n, y_n) \\
 k_{n2} &= f\left(t_n + \frac{1}{2}h, y_n + \frac{1}{2}hk_{n1}\right) \\
 k_{n3} &= f\left(t_n + \frac{1}{2}h, y_n + \frac{1}{2}hk_{n2}\right) \\
 k_{n4} &= f(t_n + h, y_n + hk_{n3}).
 \end{aligned}$$

The next estimate is given as the weighted average

$$y_{n+1} = y_n + \frac{h}{6}(k_{n1} + 2k_{n2} + 2k_{n3} + k_{n4}).$$

(a). For  $h = 0.1$  :

	$n = 1$	$n = 2$	$n = 3$	$n = 4$
$t_n$	0.1	0.2	0.3	0.4
$y_n$	0.510170	0.524138	0.542105	0.564286

(b). For  $h = 0.05$  :

	$n = 2$	$n = 4$	$n = 6$	$n = 8$
$t_n$	0.1	0.2	0.3	0.4
$y_n$	0.520169	0.524138	0.542105	0.564286

The exact solution of the IVP is  $y(t) = (3 + t^2)/(6 - t)$ .

6. In this problem,  $f(t, y) = (t^2 - y^2)\sin y$ . At each time step, the Runge-Kutta algorithm requires the evaluations

$$\begin{aligned}
 k_{n1} &= f(t_n, y_n) \\
 k_{n2} &= f\left(t_n + \frac{1}{2}h, y_n + \frac{1}{2}hk_{n1}\right) \\
 k_{n3} &= f\left(t_n + \frac{1}{2}h, y_n + \frac{1}{2}hk_{n2}\right) \\
 k_{n4} &= f(t_n + h, y_n + hk_{n3}).
 \end{aligned}$$

The next estimate is given as the weighted average

$$y_{n+1} = y_n + \frac{h}{6}(k_{n1} + 2k_{n2} + 2k_{n3} + k_{n4}).$$



(a). For  $h = 0.1$  :

	$n = 1$	$n = 2$	$n = 3$	$n = 4$
$t_n$	0.1	0.2	0.3	0.4
$y_n$	- 0.924517	- 0.864125	- 0.816377	- 0.779706

(b). For  $h = 0.05$  :

	$n = 2$	$n = 4$	$n = 6$	$n = 8$
$t_n$	0.1	0.2	0.3	0.4
$y_n$	- 0.924517	- 0.864125	- 0.816377	- 0.779706

7. (a). For  $h = 0.1$  :

	$n = 5$	$n = 10$	$n = 15$	$n = 20$
$t_n$	0.5	1.0	1.5	2.0
$y_n$	2.96825	7.88889	20.8349	55.5957

(b). For  $h = 0.05$  :

	$n = 10$	$n = 20$	$n = 30$	$n = 40$
$t_n$	0.5	1.0	1.5	2.0
$y_n$	2.96828	7.88904	20.8355	55.5980

The exact solution of the IVP is  $y(t) = e^{2t} + t/2$ .

8. See Prob. 2. for the *exact* solution.

(a). For  $h = 0.1$  :

	$n = 5$	$n = 10$	$n = 15$	$n = 20$
$t_n$	0.5	1.0	1.5	2.0
$y_n$	0.925725	1.28516	2.40860	4.10350

(b). For  $h = 0.05$  :

	$n = 10$	$n = 20$	$n = 30$	$n = 40$
$t_n$	0.5	1.0	1.5	2.0
$y_n$	0.925711	1.28515	2.40860	4.10350

9(a). For  $h = 0.1$  :

	$n = 5$	$n = 10$	$n = 15$	$n = 20$
$t_n$	0.5	1.0	1.5	2.0
$y_n$	3.96219	5.10890	6.43139	7.92338

(b). For  $h = 0.05$  :

	$n = 10$	$n = 20$	$n = 30$	$n = 40$
$t_n$	0.5	1.0	1.5	2.0
$y_n$	3.96219	5.10890	6.43139	7.92338

The exact solution is given *implicitly* as

$$\ln \left[ \frac{2}{y+t-1} \right] + 2\sqrt{t+y} - 2 \operatorname{arctanh} \sqrt{t+y} = t + 2\sqrt{3} - 2 \operatorname{arctanh} \sqrt{3} .$$

10. See Prob. 4.

(a). For  $h = 0.1$  :

	$n = 5$	$n = 10$	$n = 15$	$n = 20$
$t_n$	0.5	1.0	1.5	2.0
$y_n$	1.61262	2.48091	3.74548	5.49587

(b). For  $h = 0.05$  :

	$n = 10$	$n = 20$	$n = 30$	$n = 40$
$t_n$	0.5	1.0	1.5	2.0
$y_n$	1.61262	2.48091	3.74548	5.49587

12. See Prob. 5. for the *exact* solution.

(a). For  $h = 0.1$  :

	$n = 5$	$n = 10$	$n = 15$	$n = 20$
$t_n$	0.5	1.0	1.5	2.0
$y_n$	0.590909	0.800000	1.166667	1.75000

(b). For  $h = 0.05$  :

	$n = 10$	$n = 20$	$n = 30$	$n = 40$
$t_n$	0.5	1.0	1.5	2.0
$y_n$	0.590909	0.800000	1.166667	1.75000

13. The ODE is linear, with  $f(t, y) = 1 - t + 4y$ . The Runge-Kutta algorithm requires

the evaluations

$$\begin{aligned}
 k_{n1} &= f(t_n, y_n) \\
 k_{n2} &= f\left(t_n + \frac{1}{2}h, y_n + \frac{1}{2}hk_{n1}\right) \\
 k_{n3} &= f\left(t_n + \frac{1}{2}h, y_n + \frac{1}{2}hk_{n2}\right) \\
 k_{n4} &= f(t_n + h, y_n + hk_{n3}).
 \end{aligned}$$

The next estimate is given as the weighted average

$$y_{n+1} = y_n + \frac{h}{6}(k_{n1} + 2k_{n2} + 2k_{n3} + k_{n4}).$$

The exact solution of the IVP is  $y(t) = \frac{19}{16}e^{4t} + \frac{1}{4}t - \frac{3}{16}$ .

(a). For  $h = 0.1$  :

	$n = 5$	$n = 10$	$n = 15$	$n = 20$
$t_n$	0.5	1.0	1.5	2.0
$y_n$	8.7093175	64.858107	478.81928	3535.8667

(b). For  $h = 0.05$  :

	$n = 10$	$n = 20$	$n = 30$	$n = 40$
$t_n$	0.5	1.0	1.5	2.0
$y_n$	8.7118060	64.894875	479.22674	3539.8804

15(a).

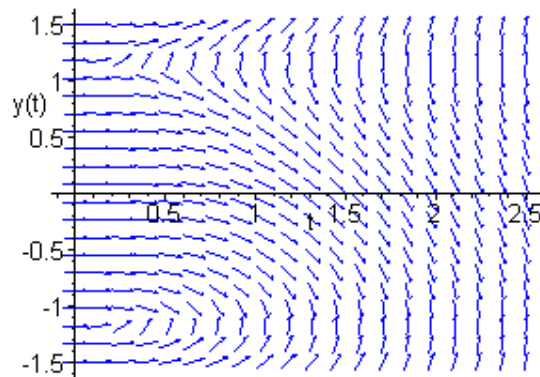

(b). For the integral curve starting at  $(0, 0)$ , the slope becomes *infinite* near  $t_M \approx 1.5$ . Note that the exact solution of the IVP is defined implicitly as

$$y^3 - 4y = t^3.$$

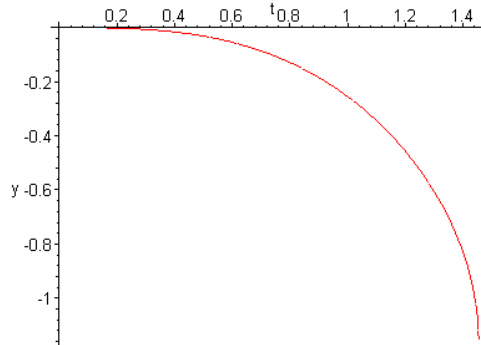

Using the classic Runge-Kutta algorithm, with  $h = 0.01$ , we obtain the values

	$n = 70$	$n = 80$	$n = 90$	$n = 95$
$t_n$	0.7	0.8	0.9	0.95
$y_n$	- 0.08591	- 0.12853	- 0.18380	- 0.21689

(c). Based on the direction field, the solution should *decrease* monotonically to the limiting value  $y = -2/\sqrt{3}$ . In the following table, the value of  $t_M$  corresponds to the approximate time in the iteration process that the calculated values begin to *increase*.

$h$	$t_M$
0.1	1.9
0.05	1.65
0.025	1.55
0.01	1.455

(d). Numerical values will continue to be generated, although they will *not* be associated with the integral curve starting at  $(0, 0)$ . These values are approximations to nearby integral curves.

(e). We consider the solution associated with the initial condition  $y(0) = 1$ . The exact solution is given by

$$y^3 - 4y = t^3 - 3.$$

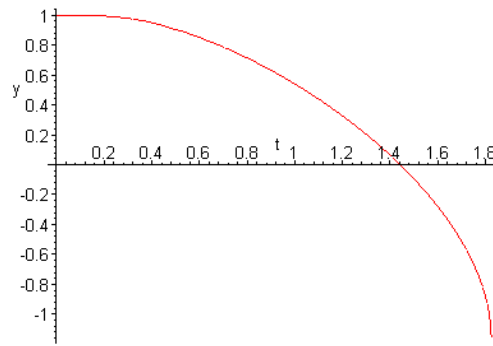

For the integral curve starting at  $(0, 1)$ , the slope becomes *infinite* near  $t_M \approx 2.0$ . In the following table, the values of  $t_M$  corresponds to the approximate time in the iteration process that the calculated values begin to *increase*.

$h$	$t_M$
0.1	1.85
0.05	1.85
0.025	1.86
0.01	1.835

## Section 8.4

1(a). Using the notation  $f_n = f(t_n, y_n)$ , the *predictor* formula is

$$y_{n+1} = y_n + \frac{h}{24}(55 f_n - 59 f_{n-1} + 37 f_{n-2} - 9 f_{n-3}).$$

With  $f_{n+1} = f(t_{n+1}, y_{n+1})$ , the *corrector* formula is

$$y_{n+1} = y_n + \frac{h}{24}(9 f_{n+1} + 19 f_n - 5 f_{n-1} + f_{n-2}).$$

We use the starting values generated by the Runge-Kutta method :

	$n = 0$	$n = 1$	$n = 2$	$n = 3$
$t_n$	0.0	0.1	0.2	0.3
$y_n$	1.0	1.19516	1.38127	1.55918

	$n = 4(pre)$	$n = 4(cor)$	$n = 5(pre)$	$n = 5(cor)$
$t_n$	0.4	0.4	0.5	0.5
$y_n$	1.72967690	1.72986801	1.89346436	1.89346973

(b). With  $f_{n+1} = f(t_{n+1}, y_{n+1})$ , the fourth order *Adams-Moulton* formula is

$$y_{n+1} = y_n + \frac{h}{24}(9 f_{n+1} + 19 f_n - 5 f_{n-1} + f_{n-2}).$$

In this problem,  $f_{n+1} = 3 + t_{n+1} - y_{n+1}$ . Since the ODE is *linear*, we can solve for

$$y_{n+1} = \frac{1}{24 + 9h} [24 y_n + 27h + 9h t_{n+1} + h(19 f_n - 5 f_{n-1} + f_{n-2})].$$

	$n = 4$	$n = 5$
$t_n$	0.4	0.5
$y_n$	1.7296800	1.8934695

(c). The fourth order *backward differentiation* formula is

$$y_{n+1} = \frac{1}{25} [48 y_n - 36 y_{n-1} + 16 y_{n-2} - 3 y_{n-3} + 12h f_{n+1}].$$

In this problem,  $f_{n+1} = 3 + t_{n+1} - y_{n+1}$ . Since the ODE is *linear*, we can solve for

$$y_{n+1} = \frac{1}{25 + 12h} [36h + 12h t_{n+1} + 48 y_n - 36 y_{n-1} + 16 y_{n-2} - 3 y_{n-3}].$$

	$n = 4$	$n = 5$
$t_n$	0.4	0.5
$y_n$	1.7296805	1.8934711

The exact solution of the IVP is  $y(t) = 2 + t - e^{-t}$ .

2(a). Using the notation  $f_n = f(t_n, y_n)$ , the *predictor* formula is

$$y_{n+1} = y_n + \frac{h}{24}(55 f_n - 59 f_{n-1} + 37 f_{n-2} - 9 f_{n-3}).$$

With  $f_{n+1} = f(t_{n+1}, y_{n+1})$ , the *corrector* formula is

$$y_{n+1} = y_n + \frac{h}{24}(9 f_{n+1} + 19 f_n - 5 f_{n-1} + f_{n-2}).$$

We use the starting values generated by the Runge-Kutta method :

	$n = 0$	$n = 1$	$n = 2$	$n = 3$
$t_n$	0.0	0.1	0.2	0.3
$y_n$	2.0	1.62231	1.33362	1.12686

	$n = 4(pre)$	$n = 4(cor)$	$n = 5(pre)$	$n = 5(cor)$
$t_n$	0.4	0.4	0.5	0.5
$y_n$	0.993751	0.993852	0.925469	0.925764

(b). With  $f_{n+1} = f(t_{n+1}, y_{n+1})$ , the fourth order *Adams-Moulton* formula is

$$y_{n+1} = y_n + \frac{h}{24}(9 f_{n+1} + 19 f_n - 5 f_{n-1} + f_{n-2}).$$

In this problem,  $f_{n+1} = 5t_{n+1} - 3\sqrt{y_{n+1}}$ . Since the ODE is *nonlinear*, an equation solver is needed to approximate the solution of

$$y_{n+1} = y_n + \frac{h}{24} [45t_{n+1} - 27\sqrt{y_{n+1}} + 19 f_n - 5 f_{n-1} + f_{n-2}]$$

at each time step. We obtain the approximate values:

	$n = 4$	$n = 5$
$t_n$	0.4	0.5
$y_n$	0.993847	0.925746

(c). The fourth order *backward differentiation* formula is

$$y_{n+1} = \frac{1}{25} [48 y_n - 36 y_{n-1} + 16 y_{n-2} - 3 y_{n-3} + 12h f_{n+1}].$$

Since the ODE is *nonlinear*, an equation solver is used to approximate the solution of

$$y_{n+1} = \frac{1}{25} [48 y_n - 36 y_{n-1} + 16 y_{n-2} - 3 y_{n-3} + 12h (5t_{n+1} - 3\sqrt{y_{n+1}})]$$

at each time step.

	$n = 4$	$n = 5$
$t_n$	0.4	0.5
$y_n$	0.993869	0.925837

The exact solution of the IVP is given *implicitly* by

$$\frac{1}{(2\sqrt{y} + 5t)^5 (t - \sqrt{y})^2} = \frac{\sqrt{2}}{512}.$$

3(a). The *predictor* formula is

$$y_{n+1} = y_n + \frac{h}{24} (55 f_n - 59 f_{n-1} + 37 f_{n-2} - 9 f_{n-3}).$$

With  $f_{n+1} = f(t_{n+1}, y_{n+1})$ , the *corrector* formula is

$$y_{n+1} = y_n + \frac{h}{24} (9 f_{n+1} + 19 f_n - 5 f_{n-1} + f_{n-2}).$$

Using the starting values generated by the Runge-Kutta method :

	$n = 0$	$n = 1$	$n = 2$	$n = 3$
$t_n$	0.0	0.1	0.2	0.3
$y_n$	1.0	1.205350	1.422954	1.655527

	$n = 4(\text{pre})$	$n = 4(\text{cor})$	$n = 5(\text{pre})$	$n = 5(\text{cor})$
$t_n$	0.4	0.4	0.5	0.5
$y_n$	1.906340	1.906382	2.179455	2.179567

(b). With  $f_{n+1} = f(t_{n+1}, y_{n+1})$ , the fourth order *Adams-Moulton* formula is

$$y_{n+1} = y_n + \frac{h}{24} (9 f_{n+1} + 19 f_n - 5 f_{n-1} + f_{n-2}).$$

In this problem,  $f_{n+1} = 2 y_{n+1} - 3 t_{n+1}$ . Since the ODE is *linear*, we can solve for



$$y_{n+1} = \frac{1}{24 - 18h} [24y_n - 27ht_{n+1} + h(19f_n - 5f_{n-1} + f_{n-2})].$$

	$n = 4$	$n = 5$
$t_n$	0.4	0.5
$y_n$	1.906385	2.179576

(c). The fourth order *backward differentiation* formula is

$$y_{n+1} = \frac{1}{25} [48y_n - 36y_{n-1} + 16y_{n-2} - 3y_{n-3} + 12hf_{n+1}].$$

In this problem,  $f_{n+1} = 2y_{n+1} - 3t_{n+1}$ . Since the ODE is *linear*, we can solve for

$$y_{n+1} = \frac{1}{25 - 24h} [48y_n - 36y_{n-1} + 16y_{n-2} - 3y_{n-3} - 36ht_{n+1}].$$

	$n = 4$	$n = 5$
$t_n$	0.4	0.5
$y_n$	1.906395	2.179611

The exact solution of the IVP is  $y(t) = e^{2t}/4 + 3t/2 + 3/4$ .

5(a). The *predictor* formula is

$$y_{n+1} = y_n + \frac{h}{24} (55f_n - 59f_{n-1} + 37f_{n-2} - 9f_{n-3}).$$

With  $f_{n+1} = f(t_{n+1}, y_{n+1})$ , the *corrector* formula is

$$y_{n+1} = y_n + \frac{h}{24} (9f_{n+1} + 19f_n - 5f_{n-1} + f_{n-2}).$$

Using the starting values generated by the Runge-Kutta method :

	$n = 0$	$n = 1$	$n = 2$	$n = 3$
$t_n$	0.0	0.1	0.2	0.3
$y_n$	0.5	0.51016950	0.52413795	0.54210529

	$n = 4(pre)$	$n = 4(cor)$	$n = 5(pre)$	$n = 5(cor)$
$t_n$	0.4	0.4	0.5	0.5
$y_n$	0.56428532	0.56428577	0.59090816	0.59090918

(b). With  $f_{n+1} = f(t_{n+1}, y_{n+1})$ , the fourth order *Adams-Moulton* formula is

$$y_{n+1} = y_n + \frac{h}{24} (9 f_{n+1} + 19 f_n - 5 f_{n-1} + f_{n-2}) .$$

In this problem,

$$f_{n+1} = \frac{y_{n+1}^2 + 2 t_{n+1} y_{n+1}}{3 + t_{n+1}^2} .$$

Since the ODE is *nonlinear*, an equation solver is needed to approximate the solution of

$$y_{n+1} = y_n + \frac{h}{24} \left[ 9 \frac{y_{n+1}^2 + 2 t_{n+1} y_{n+1}}{3 + t_{n+1}^2} + 19 f_n - 5 f_{n-1} + f_{n-2} \right]$$

at each time step.

	$n = 4$	$n = 5$
$t_n$	0.4	0.5
$y_n$	0.56428578	0.59090920

(c). The fourth order *backward differentiation* formula is

$$y_{n+1} = \frac{1}{25} [48 y_n - 36 y_{n-1} + 16 y_{n-2} - 3 y_{n-3} + 12h f_{n+1}] .$$

Since the ODE is *nonlinear*, an equation solver is needed to approximate the solution of

$$y_{n+1} = \frac{1}{25} \left[ 48 y_n - 36 y_{n-1} + 16 y_{n-2} - 3 y_{n-3} + 12h \frac{y_{n+1}^2 + 2 t_{n+1} y_{n+1}}{3 + t_{n+1}^2} \right]$$

at each time step. We obtain the approximate values:

	$n = 4$	$n = 5$
$t_n$	0.4	0.5
$y_n$	0.56428588	0.59090952

The exact solution of the IVP is  $y(t) = (3 + t^2)/(6 - t)$ .

6(a). The *predictor* formula is

$$y_{n+1} = y_n + \frac{h}{24}(55 f_n - 59 f_{n-1} + 37 f_{n-2} - 9 f_{n-3}).$$

With  $f_{n+1} = f(t_{n+1}, y_{n+1})$ , the *corrector* formula is

$$y_{n+1} = y_n + \frac{h}{24}(9 f_{n+1} + 19 f_n - 5 f_{n-1} + f_{n-2}).$$

We use the starting values generated by the Runge-Kutta method :

	$n = 0$	$n = 1$	$n = 2$	$n = 3$
$t_n$	0.0	0.1	0.2	0.3
$y_n$	-1.0	-0.924517	-0.864125	-0.816377

	$n = 4(\text{pre})$	$n = 4(\text{cor})$	$n = 5(\text{pre})$	$n = 5(\text{cor})$
$t_n$	0.4	0.4	0.5	0.5
$y_n$	-0.779832	-0.779693	-0.753311	-0.753135

(b). With  $f_{n+1} = f(t_{n+1}, y_{n+1})$ , the fourth order *Adams-Moulton* formula is

$$y_{n+1} = y_n + \frac{h}{24}(9 f_{n+1} + 19 f_n - 5 f_{n-1} + f_{n-2}).$$

In this problem,  $f_{n+1} = (t_{n+1}^2 - y_{n+1}^2) \sin y_{n+1}$ . Since the ODE is *nonlinear*, we obtain the *implicit* equation

$$y_{n+1} = y_n + \frac{h}{24} [9(t_{n+1}^2 - y_{n+1}^2) \sin y_{n+1} + 19 f_n - 5 f_{n-1} + f_{n-2}].$$

	$n = 4$	$n = 5$
$t_n$	0.4	0.5
$y_n$	-0.779700	-0.753144

(c). The fourth order *backward differentiation* formula is

$$y_{n+1} = \frac{1}{25} [48 y_n - 36 y_{n-1} + 16 y_{n-2} - 3 y_{n-3} + 12h f_{n+1}].$$

Since the ODE is *nonlinear*, we obtain the *implicit* equation

$$y_{n+1} = \frac{1}{25} [48 y_n - 36 y_{n-1} + 16 y_{n-2} - 3 y_{n-3} + 12h (t_{n+1}^2 - y_{n+1}^2) \sin y_{n+1}].$$

	$n = 4$	$n = 5$
$t_n$	0.4	0.5
$y_n$	- 0.779680	- 0.753089

8(a). The *predictor* formula is

$$y_{n+1} = y_n + \frac{h}{24} (55 f_n - 59 f_{n-1} + 37 f_{n-2} - 9 f_{n-3}).$$

With  $f_{n+1} = f(t_{n+1}, y_{n+1})$ , the *corrector* formula is

$$y_{n+1} = y_n + \frac{h}{24} (9 f_{n+1} + 19 f_n - 5 f_{n-1} + f_{n-2}).$$

We use the starting values generated by the Runge-Kutta method :

	$n = 0$	$n = 1$	$n = 2$	$n = 3$
$t_n$	0.0	0.05	0.1	0.15
$y_n$	2.0	1.7996296	1.6223042	1.4672503

	$n = 10$	$n = 20$	$n = 30$	$n = 40$
$t_n$	0.5	1.0	1.5	2.0
$y_n$	0.9257133	1.285148	2.408595	4.103495

(b). Since the ODE is *nonlinear*, an equation solver is needed to approximate the solution of

$$y_{n+1} = y_n + \frac{h}{24} [45t_{n+1} - 27\sqrt{y_{n+1}} + 19 f_n - 5 f_{n-1} + f_{n-2}]$$

at each time step. We obtain the approximate values:

	$n = 10$	$n = 20$	$n = 30$	$n = 40$
$t_n$	0.5	1.0	1.5	2.0
$y_n$	0.9257125	1.285148	2.408595	4.103495

(c). The fourth order *backward differentiation* formula is

$$y_{n+1} = \frac{1}{25} [48 y_n - 36 y_{n-1} + 16 y_{n-2} - 3 y_{n-3} + 12h f_{n+1}].$$

Since the ODE is *nonlinear*, an equation solver is needed to approximate the solution of

$$y_{n+1} = \frac{1}{25} [48 y_n - 36 y_{n-1} + 16 y_{n-2} - 3 y_{n-3} + 12h (5t_{n+1} - 3\sqrt{y_{n+1}})]$$

at each time step.

	$n = 10$	$n = 20$	$n = 30$	$n = 40$
$t_n$	0.5	1.0	1.5	2.0
$y_n$	0.9257248	1.285158	2.408594	4.103493

The exact solution of the IVP is given *implicitly* by

$$\frac{1}{(2\sqrt{y} + 5t)^5 (t - \sqrt{y})^2} = \frac{\sqrt{2}}{512}.$$

9(a). The *predictor* formula is

$$y_{n+1} = y_n + \frac{h}{24} (55 f_n - 59 f_{n-1} + 37 f_{n-2} - 9 f_{n-3}).$$

With  $f_{n+1} = f(t_{n+1}, y_{n+1})$ , the *corrector* formula is

$$y_{n+1} = y_n + \frac{h}{24} (9 f_{n+1} + 19 f_n - 5 f_{n-1} + f_{n-2}).$$

Using the starting values generated by the Runge-Kutta method :

	$n = 0$	$n = 1$	$n = 2$	$n = 3$
$t_n$	0.0	0.05	0.1	0.15
$y_n$	3.0	3.087586	3.177127	3.268609

	$n = 10$	$n = 20$	$n = 30$	$n = 40$
$t_n$	0.5	1.0	1.5	2.0
$y_n$	3.962186	5.108903	6.431390	7.923385

(b). With  $f_{n+1} = f(t_{n+1}, y_{n+1})$ , the fourth order *Adams-Moulton* formula is

$$y_{n+1} = y_n + \frac{h}{24} (9 f_{n+1} + 19 f_n - 5 f_{n-1} + f_{n-2}).$$

In this problem,  $f_{n+1} = \sqrt{t_{n+1} + y_{n+1}}$ . Since the ODE is *nonlinear*, an equation solver must be implemented in order to approximate the solution of

$$y_{n+1} = y_n + \frac{h}{24} [9\sqrt{t_{n+1} + y_{n+1}} + 19f_n - 5f_{n-1} + f_{n-2}]$$

at each time step.

	$n = 10$	$n = 20$	$n = 30$	$n = 40$
$t_n$	0.5	1.0	1.5	2.0
$y_n$	3.962186	5.108903	6.431390	7.923385

(c). The fourth order *backward differentiation* formula is

$$y_{n+1} = \frac{1}{25} [48y_n - 36y_{n-1} + 16y_{n-2} - 3y_{n-3} + 12hf_{n+1}].$$

Since the ODE is *nonlinear*, an equation solver is needed to approximate the solution of

$$y_{n+1} = \frac{1}{25} [48y_n - 36y_{n-1} + 16y_{n-2} - 3y_{n-3} + 12h\sqrt{t_{n+1} + y_{n+1}}]$$

at each time step.

	$n = 10$	$n = 20$	$n = 30$	$n = 40$
$t_n$	0.5	1.0	1.5	2.0
$y_n$	3.962186	5.108903	6.431390	7.923385

The exact solution is given *implicitly* by

$$\ln \left[ \frac{2}{y + t - 1} \right] + 2\sqrt{t + y} - 2 \operatorname{arctanh} \sqrt{t + y} = t + 2\sqrt{3} - 2 \operatorname{arctanh} \sqrt{3}.$$

10(a). The *predictor* formula is

$$y_{n+1} = y_n + \frac{h}{24}(55 f_n - 59 f_{n-1} + 37 f_{n-2} - 9 f_{n-3}).$$

With  $f_{n+1} = f(t_{n+1}, y_{n+1})$ , the *corrector* formula is

$$y_{n+1} = y_n + \frac{h}{24}(9 f_{n+1} + 19 f_n - 5 f_{n-1} + f_{n-2}).$$

We use the starting values generated by the Runge-Kutta method :

	$n = 0$	$n = 1$	$n = 2$	$n = 3$
$t_n$	0.0	0.05	0.1	0.15
$y_n$	1.0	1.051230	1.104843	1.160740

	$n = 10$	$n = 20$	$n = 30$	$n = 40$
$t_n$	0.5	1.0	1.5	2.0
$y_n$	1.612622	2.480909	3.7451479	5.495872

(b). With  $f_{n+1} = f(t_{n+1}, y_{n+1})$ , the fourth order *Adams-Moulton* formula is

$$y_{n+1} = y_n + \frac{h}{24}(9 f_{n+1} + 19 f_n - 5 f_{n-1} + f_{n-2}).$$

In this problem,  $f_{n+1} = 2 t_{n+1} + \exp(-t_{n+1} y_{n+1})$ . Since the ODE is *nonlinear*, an equation solver must be implemented in order to approximate the solution of

$$y_{n+1} = y_n + \frac{h}{24}\{9[2 t_{n+1} + \exp(-t_{n+1} y_{n+1})] + 19 f_n - 5 f_{n-1} + f_{n-2}\}$$

at each time step.

	$n = 10$	$n = 20$	$n = 30$	$n = 40$
$t_n$	0.5	1.0	1.5	2.0
$y_n$	1.612622	2.480909	3.7451479	5.495872

(c). The fourth order *backward differentiation* formula is

$$y_{n+1} = \frac{1}{25}[48 y_n - 36 y_{n-1} + 16 y_{n-2} - 3 y_{n-3} + 12 h f_{n+1}].$$

Since the ODE is *nonlinear*, we obtain the *implicit* equation

$$y_{n+1} = \frac{1}{25}\{48 y_n - 36 y_{n-1} + 16 y_{n-2} - 3 y_{n-3} + 12 h[2 t_{n+1} + \exp(-t_{n+1} y_{n+1})]\}.$$

	$n = 10$	$n = 20$	$n = 30$	$n = 40$
$t_n$	0.5	1.0	1.5	2.0
$y_n$	1.612623	2.480905	3.7451473	5.495869

11(a). The *predictor* formula is

$$y_{n+1} = y_n + \frac{h}{24}(55 f_n - 59 f_{n-1} + 37 f_{n-2} - 9 f_{n-3}).$$

With  $f_{n+1} = f(t_{n+1}, y_{n+1})$ , the *corrector* formula is

$$y_{n+1} = y_n + \frac{h}{24}(9 f_{n+1} + 19 f_n - 5 f_{n-1} + f_{n-2}).$$

Using the starting values generated by the Runge-Kutta method :

	$n = 0$	$n = 1$	$n = 2$	$n = 3$
$t_n$	0.0	0.05	0.1	0.15
$y_n$	- 2.0	- 1.958833	- 1.915221	- 1.868975

	$n = 10$	$n = 20$	$n = 30$	$n = 40$
$t_n$	0.5	1.0	1.5	2.0
$y_n$	- 1.447639	- 0.1436281	1.060946	1.410122

(b). With  $f_{n+1} = f(t_{n+1}, y_{n+1})$ , the fourth order *Adams-Moulton* formula is

$$y_{n+1} = y_n + \frac{h}{24}(9 f_{n+1} + 19 f_n - 5 f_{n-1} + f_{n-2}).$$

In this problem,

$$f_{n+1} = \frac{4 - t_{n+1} y_{n+1}}{1 + y_{n+1}^2}.$$

Since the differential equation is *nonlinear*, an equation solver is used to approximate the solution of

$$y_{n+1} = y_n + \frac{h}{24} \left[ 9 \frac{4 - t_{n+1} y_{n+1}}{1 + y_{n+1}^2} + 19 f_n - 5 f_{n-1} + f_{n-2} \right]$$

at each time step.

	$n = 10$	$n = 20$	$n = 30$	$n = 40$
$t_n$	0.5	1.0	1.5	2.0
$y_n$	- 1.447638	- 0.1436767	1.060913	1.410103



(c). The fourth order *backward differentiation* formula is

$$y_{n+1} = \frac{1}{25} [48 y_n - 36 y_{n-1} + 16 y_{n-2} - 3 y_{n-3} + 12h f_{n+1}].$$

Since the ODE is *nonlinear*, an equation solver must be implemented in order to approximate the solution of

$$y_{n+1} = \frac{1}{25} \left[ 48 y_n - 36 y_{n-1} + 16 y_{n-2} - 3 y_{n-3} + 12h \frac{4 - t_{n+1} y_{n+1}}{1 + y_{n+1}^2} \right]$$

at each time step.

	$n = 10$	$n = 20$	$n = 30$	$n = 40$
$t_n$	0.5	1.0	1.5	2.0
$y_n$	- 1.447621	- 0.1447619	1.060717	1.410027

12(a). The *predictor* formula is

$$y_{n+1} = y_n + \frac{h}{24} (55 f_n - 59 f_{n-1} + 37 f_{n-2} - 9 f_{n-3}).$$

With  $f_{n+1} = f(t_{n+1}, y_{n+1})$ , the *corrector* formula is

$$y_{n+1} = y_n + \frac{h}{24} (9 f_{n+1} + 19 f_n - 5 f_{n-1} + f_{n-2}).$$

We use the starting values generated by the Runge-Kutta method :

	$n = 0$	$n = 1$	$n = 2$	$n = 3$
$t_n$	0.0	0.05	0.1	0.15
$y_n$	0.5	0.5046218	0.5101695	0.5166666

	$n = 10$	$n = 20$	$n = 30$	$n = 40$
$t_n$	0.5	1.0	1.5	2.0
$y_n$	0.5909091	0.8000000	1.166667	1.750000

(b). With  $f_{n+1} = f(t_{n+1}, y_{n+1})$ , the fourth order *Adams-Moulton* formula is

$$y_{n+1} = y_n + \frac{h}{24} (9 f_{n+1} + 19 f_n - 5 f_{n-1} + f_{n-2}).$$

In this problem,

$$f_{n+1} = \frac{y_{n+1}^2 + 2t_{n+1}y_{n+1}}{3 + t_{n+1}^2}.$$

Since the ODE is *nonlinear*, an equation solver is needed to approximate the solution of

$$y_{n+1} = y_n + \frac{h}{24} \left[ 9 \frac{y_{n+1}^2 + 2t_{n+1}y_{n+1}}{3 + t_{n+1}^2} + 19f_n - 5f_{n-1} + f_{n-2} \right]$$

at each time step.

	$n = 10$	$n = 20$	$n = 30$	$n = 40$
$t_n$	0.5	1.0	1.5	2.0
$y_n$	0.5909091	0.8000000	1.166667	1.750000

(c). The fourth order *backward differentiation* formula is

$$y_{n+1} = \frac{1}{25} [48y_n - 36y_{n-1} + 16y_{n-2} - 3y_{n-3} + 12hf_{n+1}].$$

Since the ODE is *nonlinear*, we obtain the *implicit* equation

$$y_{n+1} = \frac{1}{25} \left[ 48y_n - 36y_{n-1} + 16y_{n-2} - 3y_{n-3} + 12h \frac{y_{n+1}^2 + 2t_{n+1}y_{n+1}}{3 + t_{n+1}^2} \right].$$

	$n = 10$	$n = 20$	$n = 30$	$n = 40$
$t_n$	0.5	1.0	1.5	2.0
$y_n$	0.5909092	0.8000002	1.166667	1.750001

The exact solution of the IVP is  $y(t) = (3 + t^2)/(6 - t)$ .

13. Both *Adams* methods entail the approximation of  $f(t, y)$ , on the interval  $[t_n, t_{n+1}]$ , by a polynomial. Approximating  $\phi'(t) = P_1(t) \equiv A$ , which is a *constant* polynomial, we have

$$\begin{aligned} \phi(t_{n+1}) - \phi(t_n) &= \int_{t_n}^{t_{n+1}} A dt \\ &= A(t_{n+1} - t_n) = Ah. \end{aligned}$$

Setting  $A = \lambda f_n + (1 - \lambda)f_{n-1}$ , where  $0 \leq \lambda \leq 1$ , we obtain the approximation

$$y_{n+1} = y_n + h[\lambda f_n + (1 - \lambda)f_{n-1}].$$

An appropriate choice of  $\lambda$  yields the familiar Euler formula. Similarly, setting

$$A = \lambda f_n + (1 - \lambda)f_{n+1},$$

where  $0 \leq \lambda \leq 1$ , we obtain the approximation

$$y_{n+1} = y_n + h[\lambda f_n + (1 - \lambda)f_{n+1}].$$

14. For a *third order* Adams-Bashforth formula, we approximate  $f(t, y)$ , on the interval  $[t_n, t_{n+1}]$ , by a *quadratic* polynomial using the points  $(t_{n-2}, y_{n-2})$ ,  $(t_{n-1}, y_{n-1})$  and  $(t_n, y_n)$ . Let  $P_3(t) = At^2 + Bt + C$ . We obtain the system of equations

$$\begin{aligned} At_{n-2}^2 + Bt_{n-2} + C &= f_{n-2} \\ At_{n-1}^2 + Bt_{n-1} + C &= f_{n-1} \\ At_n^2 + Bt_n + C &= f_n. \end{aligned}$$

For computational purposes, assume that  $t_0 = 0$ , and  $t_n = nh$ . It follows that

$$\begin{aligned} A &= \frac{f_n - 2f_{n-1} + f_{n-2}}{2h^2} \\ B &= \frac{(3 - 2n)f_n + (4n - 4)f_{n-1} + (1 - 2n)f_{n-2}}{2h} \\ C &= \frac{n^2 - 3n + 2}{2}f_n + (2n - n^2)f_{n-1} + \frac{n^2 - n}{2}f_{n-2}. \end{aligned}$$

We then have

$$\begin{aligned} y_{n+1} - y_n &= \int_{t_n}^{t_{n+1}} [At^2 + Bt + C] dt \\ &= Ah^3 \left( n^2 + n + \frac{1}{3} \right) + Bh^2 \left( n + \frac{1}{2} \right) + Ch, \end{aligned}$$

which yields

$$y_{n+1} - y_n = \frac{h}{12}(23f_n - 16f_{n-1} + 5f_{n-2}).$$

15. For a *third order* Adams-Moulton formula, we approximate  $f(t, y)$ , on the interval  $[t_n, t_{n+1}]$ , by a *quadratic* polynomial using the points  $(t_{n-1}, y_{n-1})$ ,  $(t_n, y_n)$  and  $(t_{n+1}, y_{n+1})$ . Let  $P_3(t) = \alpha t^2 + \beta t + \gamma$ . This time we obtain the system of algebraic equations

$$\begin{aligned} \alpha t_{n-1}^2 + \beta t_{n-1} + \gamma &= f_{n-1} \\ \alpha t_n^2 + \beta t_n + \gamma &= f_n \\ \alpha t_{n+1}^2 + \beta t_{n+1} + \gamma &= f_{n+1}. \end{aligned}$$

For computational purposes, again assume that  $t_0 = 0$ , and  $t_n = nh$ . It follows that

$$\alpha = \frac{f_{n-1} - 2f_n + f_{n+1}}{2h^2}$$

$$\beta = \frac{-(2n+1)f_{n-1} + 4nf_n + (1-2n)f_{n+1}}{2h}$$

$$\gamma = \frac{n^2+n}{2}f_{n-1} + (1-n^2)f_n + \frac{n^2-n}{2}f_{n+1}.$$

We then have

$$y_{n+1} - y_n = \int_{t_n}^{t_{n+1}} [\alpha t^2 + \beta t + \gamma] dt$$

$$= \alpha h^3 \left( n^2 + n + \frac{1}{3} \right) + \beta h^2 \left( n + \frac{1}{2} \right) + \gamma h,$$

which results in

$$y_{n+1} - y_n = \frac{h}{12} (5f_{n+1} + 8f_n - f_{n-1}).$$

**Section 8.5**

1(a). The *general* solution of the ODE is  $y(t) = c e^t + 2 - t$ . Imposing the initial condition,  $y(0) = 2$ , the solution of the IVP is  $\phi_1(t) = 2 - t$ .

(b). If instead, the initial condition  $y(0) = 2.001$  is given, the solution of the IVP is  $\phi_2(t) = 0.001 e^t + 2 - t$ . We then have  $\phi_2(t) - \phi_1(t) = 0.001 e^t$ .

3. The solution of the initial value problem is  $\phi(t) = e^{-100t} + t$ .

(a, b). Based on the exact solution, the *local truncation error* for both of the Euler methods is

$$|e_{loc}| \leq \frac{10^4}{2} e^{-100\bar{t}_n} h^2.$$

Hence  $|e_n| \leq 5000 h^2$ , for all  $0 < \bar{t}_n < 1$ . Furthermore, the local truncation error is *greatest* near  $t = 0$ . Therefore  $|e_1| \leq 5000 h^2 < 0.0005$  for  $h < 0.0003$ . Now the truncation error accumulates at each time step. Therefore the *actual* time step should be much smaller than  $h \approx 0.0003$ . For example, with  $h = 0.00025$ , we obtain the data

	<i>Euler</i>	<i>B.Euler</i>	$\phi(t)$
$t = 0.05$	0.056323	0.057165	0.056738
$t = 0.1$	0.100040	0.100051	0.100045

Note that the total number of time steps needed to reach  $t = 0.1$  is  $N = 400$ .

(c). Using the Runge-Kutta method, comparisons are made for several values of  $h$  :

$h = 0.1$  :

	$\phi(t)$	$y_n$	$y_n - \phi(t_n)$
$t = 0.05$	0.056738	0.057416	0.000678
$t = 0.1$	0.100045	0.100055	0.000010

$h = 0.005$  :

	$\phi(t)$	$y_n$	$y_n - \phi(t_n)$
$t = 0.05$	0.056738	0.056766	0.000027
$t = 0.1$	0.100045	0.100046	0.0000004

6(a). Using the method of *undetermined coefficients*, it is easy to show that the general solution of the ODE is  $y(t) = c e^{\lambda t} + t^2$ . Imposing the initial condition, it follows that  $c = 0$  and hence the solution of the IVP is  $\phi(t) = t^2$ .

(b). Using the Runge-Kutta method, with  $h = 0.01$ , numerical solutions are generated

**Section 8.5**

1(a). The *general* solution of the ODE is  $y(t) = c e^t + 2 - t$ . Imposing the initial condition,  $y(0) = 2$ , the solution of the IVP is  $\phi_1(t) = 2 - t$ .

(b). If instead, the initial condition  $y(0) = 2.001$  is given, the solution of the IVP is  $\phi_2(t) = 0.001 e^t + 2 - t$ . We then have  $\phi_2(t) - \phi_1(t) = 0.001 e^t$ .

3. The solution of the initial value problem is  $\phi(t) = e^{-100t} + t$ .

(a, b). Based on the exact solution, the *local truncation error* for both of the Euler methods is

$$|e_{loc}| \leq \frac{10^4}{2} e^{-100\bar{t}_n} h^2.$$

Hence  $|e_n| \leq 5000 h^2$ , for all  $0 < \bar{t}_n < 1$ . Furthermore, the local truncation error is *greatest* near  $t = 0$ . Therefore  $|e_1| \leq 5000 h^2 < 0.0005$  for  $h < 0.0003$ . Now the truncation error accumulates at each time step. Therefore the *actual* time step should be much smaller than  $h \approx 0.0003$ . For example, with  $h = 0.00025$ , we obtain the data

	<i>Euler</i>	<i>B.Euler</i>	$\phi(t)$
$t = 0.05$	0.056323	0.057165	0.056738
$t = 0.1$	0.100040	0.100051	0.100045

Note that the total number of time steps needed to reach  $t = 0.1$  is  $N = 400$ .

(c). Using the Runge-Kutta method, comparisons are made for several values of  $h$  :

$h = 0.1$  :

	$\phi(t)$	$y_n$	$y_n - \phi(t_n)$
$t = 0.05$	0.056738	0.057416	0.000678
$t = 0.1$	0.100045	0.100055	0.000010

$h = 0.005$  :

	$\phi(t)$	$y_n$	$y_n - \phi(t_n)$
$t = 0.05$	0.056738	0.056766	0.000027
$t = 0.1$	0.100045	0.100046	0.0000004

6(a). Using the method of *undetermined coefficients*, it is easy to show that the general solution of the ODE is  $y(t) = c e^{\lambda t} + t^2$ . Imposing the initial condition, it follows that  $c = 0$  and hence the solution of the IVP is  $\phi(t) = t^2$ .

(b). Using the Runge-Kutta method, with  $h = 0.01$ , numerical solutions are generated

for various values of  $\lambda$  :

$\lambda = 1$  :

	$\phi(t)$	$y_n$	$ y_n - \phi(t_n) $
$t = 0.25$	0.0625	0.0624999..	$2 \times 10^{-11}$
$t = 0.5$	0.25	0.25	0
$t = 0.75$	0.5625	0.5625	0
$t = 1.0$	1.0	1.0	0

$\lambda = 10$  :

	$\phi(t)$	$y_n$	$ y_n - \phi(t_n) $
$t = 0.25$	0.0625	0.0624998..	$2.215 \times 10^{-7}$
$t = 0.5$	0.25	0.249997	$2.920 \times 10^{-6}$
$t = 0.75$	0.5625	0.562464	$3.579 \times 10^{-5}$
$t = 1.0$	1.0	0.999564	$4.362 \times 10^{-4}$

$\lambda = 20$  :

	$\phi(t)$	$y_n$	$ y_n - \phi(t_n) $
$t = 0.25$	0.0625	0.062889..	$1.10 \times 10^{-5}$
$t = 0.5$	0.25	0.248342	$1.658 \times 10^{-3}$
$t = 0.75$	0.5625	0.316458	0.246042
$t = 1.0$	1.0	-35.5139	36.5139

$\lambda = 50$  :

	$\phi(t)$	$y_n$	$ y_n - \phi(t_n) $
$t = 0.25$	0.0625	-0.044803..	0.107303
$t = 0.5$	0.25	-28669.55	28669.804
$t = 0.75$	0.5625	$-7.66014 \times 10^9$	$7.66014 \times 10^9$
$t = 1.0$	1.0	$-2.04668 \times 10^{15}$	$2.04668 \times 10^{15}$

The following table shows the calculated value,  $y_1$ , at the *first* time step :

$\phi(t)$	$y_1(\lambda = 1)$	$y_1(\lambda = 10)$	$y_1(\lambda = 20)$	$y_1(\lambda = 50)$
$10^{-4}$	$9.99999 \times 10^{-5}$	$9.99979 \times 10^{-5}$	$9.99833 \times 10^{-5}$	$9.97396 \times 10^{-5}$

(c). Referring back to the *exact* solution given in Part(a), if a *nonzero* initial condition, say  $y(0) = \varepsilon$ , is specified, the solution of the IVP becomes

$$\phi_\varepsilon(t) = \varepsilon e^{\lambda t} + t^2.$$

We then have  $|\phi(t) - \phi_\varepsilon(t)| = |\varepsilon| e^{\lambda t}$ . It is evident that for any  $t > 0$ ,

$$\lim_{\lambda \rightarrow \infty} |\phi(t) - \phi_\varepsilon(t)| = \infty .$$

This implies that virtually any error introduced early in the calculations will be magnified as  $\lambda \rightarrow \infty$ . The initial value problem is inherently *unstable*.



**Section 8.6**

1. In vector notation, the initial value problem can be written as

$$\frac{d}{dt} \begin{pmatrix} x \\ y \end{pmatrix} = \begin{pmatrix} x + y + t \\ 4x - 2y \end{pmatrix}, \quad \mathbf{x}(0) = \begin{pmatrix} 1 \\ 0 \end{pmatrix}.$$

(a). The Euler formula is

$$\begin{pmatrix} x_{n+1} \\ y_{n+1} \end{pmatrix} = \begin{pmatrix} x_n \\ y_n \end{pmatrix} + h \begin{pmatrix} x_n + y_n + t_n \\ 4x_n - 2y_n \end{pmatrix}.$$

That is,

$$\begin{aligned} x_{n+1} &= x_n + h(x_n + y_n + t_n) \\ y_{n+1} &= y_n + h(4x_n - 2y_n). \end{aligned}$$

With  $h = 0.1$ , we obtain the values

	$n = 2$	$n = 4$	$n = 6$	$n = 8$	$n = 10$
$t_n$	0.2	0.4	0.6	0.8	1.0
$x_n$	1.26	1.7714	2.58991	3.82374	5.64246
$y_n$	0.76	1.4824	2.3703	3.60413	5.38885

(b). The Runge-Kutta method uses the following intermediate calculations:

$$\begin{aligned} \mathbf{k}_{n1} &= (x_n + y_n + t_n, 4x_n - 2y_n)^T \\ \mathbf{k}_{n2} &= \left[ x_n + \frac{h}{2}k_{n1}^1 + y_n + \frac{h}{2}k_{n1}^2 + t_n + \frac{h}{2}, 4\left(x_n + \frac{h}{2}k_{n1}^1\right) - 2\left(y_n + \frac{h}{2}k_{n1}^2\right) \right]^T \\ \mathbf{k}_{n3} &= \left[ x_n + \frac{h}{2}k_{n2}^1 + y_n + \frac{h}{2}k_{n2}^2 + t_n + \frac{h}{2}, 4\left(x_n + \frac{h}{2}k_{n2}^1\right) - 2\left(y_n + \frac{h}{2}k_{n2}^2\right) \right]^T \\ \mathbf{k}_{n4} &= [x_n + hk_{n3}^1 + y_n + hk_{n3}^2 + t_n + h, 4(x_n + hk_{n3}^1) - 2(y_n + hk_{n3}^2)]^T. \end{aligned}$$

With  $h = 0.2$ , we obtain the values:

	$n = 1$	$n = 2$	$n = 3$	$n = 4$	$n = 5$
$t_n$	0.2	0.4	0.6	0.8	1.0
$x_n$	1.32493	1.93679	2.93414	4.48318	6.84236
$y_n$	0.758933	1.57919	2.66099	4.22639	6.56452

(c). With  $h = 0.1$ , we obtain

	$n = 2$	$n = 4$	$n = 6$	$n = 8$	$n = 10$
$t_n$	0.2	0.4	0.6	0.8	1.0
$x_n$	1.32489	1.9369	2.93459	4.48422	6.8444
$y_n$	0.759516	1.57999	2.66201	4.22784	6.56684

The exact solution of the IVP is

$$x(t) = e^{2t} + \frac{2}{9}e^{-3t} - \frac{1}{3}t - \frac{2}{9}$$

$$y(t) = e^{2t} - \frac{8}{9}e^{-3t} - \frac{2}{3}t - \frac{1}{9}.$$

3(a). The Euler formula is

$$\begin{pmatrix} x_{n+1} \\ y_{n+1} \end{pmatrix} = \begin{pmatrix} x_n \\ y_n \end{pmatrix} + h \begin{pmatrix} -t_n x_n - y_n - 1 \\ x_n \end{pmatrix}.$$

That is,

$$x_{n+1} = x_n + h(-t_n x_n - y_n - 1)$$

$$y_{n+1} = y_n + h(x_n).$$

With  $h = 0.1$ , we obtain the values

	$n = 2$	$n = 4$	$n = 6$	$n = 8$	$n = 10$
$t_n$	0.2	0.4	0.6	0.8	1.0
$x_n$	0.582	0.117969	-0.336912	-0.730007	-1.02134
$y_n$	1.18	1.27344	1.27382	1.18572	1.02371

(b). The Runge-Kutta method uses the following intermediate calculations:

$$\mathbf{k}_{n1} = (-t_n x_n - y_n - 1, x_n)^T$$

$$\mathbf{k}_{n2} = \left[ -\left(t_n + \frac{h}{2}\right) \left(x_n + \frac{h}{2} k_{n1}^1\right) - \left(y_n + \frac{h}{2} k_{n1}^2\right) - 1, x_n + \frac{h}{2} k_{n1}^1 \right]^T$$

$$\mathbf{k}_{n3} = \left[ -\left(t_n + \frac{h}{2}\right) \left(x_n + \frac{h}{2} k_{n2}^1\right) - \left(y_n + \frac{h}{2} k_{n2}^2\right) - 1, x_n + \frac{h}{2} k_{n2}^1 \right]^T$$

$$\mathbf{k}_{n4} = \left[ -(t_n + h) \left(x_n + h k_{n3}^1\right) - \left(y_n + h k_{n3}^2\right) - 1, x_n + h k_{n3}^1 \right]^T.$$

With  $h = 0.2$ , we obtain the values:

	$n = 1$	$n = 2$	$n = 3$	$n = 4$	$n = 5$
$t_n$	0.2	0.4	0.6	0.8	1.0
$x_n$	0.568451	0.109776	- 0.32208	- 0.681296	- 0.937852
$y_n$	1.15775	1.22556	1.20347	1.10162	0.937852

(c). With  $h = 0.1$ , we obtain

	$n = 2$	$n = 4$	$n = 6$	$n = 8$	$n = 10$
$t_n$	0.2	0.4	0.6	0.8	1.0
$x_n$	0.56845	0.109773	- 0.322081	- 0.681291	- 0.937841
$y_n$	1.15775	1.22557	1.20347	1.10161	0.93784

4(a). The Euler formula gives

$$\begin{aligned}x_{n+1} &= x_n + h(x_n - y_n + x_n y_n) \\y_{n+1} &= y_n + h(3x_n - 2y_n - x_n y_n).\end{aligned}$$

With  $h = 0.1$ , we obtain the values

	$n = 2$	$n = 4$	$n = 6$	$n = 8$	$n = 10$
$t_n$	0.2	0.4	0.6	0.8	1.0
$x_n$	- 0.198	- 0.378796	- 0.51932	- 0.594324	- 0.588278
$y_n$	0.618	0.28329	- 0.0321025	- 0.326801	- 0.57545

(b). Given

$$\begin{aligned}f(t, x, y) &= x - y + xy \\g(t, x, y) &= 3x - 2y - xy,\end{aligned}$$

the Runge-Kutta method uses the following intermediate calculations:

$$\begin{aligned}\mathbf{k}_{n1} &= [f(t_n, x_n, y_n), g(t_n, x_n, y_n)]^T \\ \mathbf{k}_{n2} &= \left[ f\left(t_n + \frac{h}{2}, x_n + \frac{h}{2}k_{n1}^1, y_n + \frac{h}{2}k_{n1}^2\right), g\left(t_n + \frac{h}{2}, x_n + \frac{h}{2}k_{n1}^1, y_n + \frac{h}{2}k_{n1}^2\right) \right]^T \\ \mathbf{k}_{n3} &= \left[ f\left(t_n + \frac{h}{2}, x_n + \frac{h}{2}k_{n2}^1, y_n + \frac{h}{2}k_{n2}^2\right), g\left(t_n + \frac{h}{2}, x_n + \frac{h}{2}k_{n2}^1, y_n + \frac{h}{2}k_{n2}^2\right) \right]^T \\ \mathbf{k}_{n4} &= [f(t_n + h, x_n + hk_{n3}^1, y_n + hk_{n3}^2), g(t_n + h, x_n + hk_{n3}^1, y_n + hk_{n3}^2)]^T.\end{aligned}$$

With  $h = 0.2$ , we obtain the values:

	$n = 1$	$n = 2$	$n = 3$	$n = 4$	$n = 5$
$t_n$	0.2	0.4	0.6	0.8	1.0
$x_n$	-0.196904	-0.372643	-0.501302	-0.561270	-0.547053
$y_n$	0.630936	0.298888	-0.0111429	-0.288943	-0.508303

(c). With  $h = 0.1$ , we obtain

	$n = 2$	$n = 4$	$n = 6$	$n = 8$	$n = 10$
$t_n$	0.2	0.4	0.6	0.8	1.0
$x_n$	-0.196935	-0.372687	-0.501345	-0.561292	-0.547031
$y_n$	0.630939	0.298866	-0.0112184	-0.28907	-0.508427

5(a). The Euler formula gives

$$\begin{aligned} x_{n+1} &= x_n + h[x_n(1 - 0.5x_n - 0.5y_n)] \\ y_{n+1} &= y_n + h[y_n(-0.25 + 0.5x_n)]. \end{aligned}$$

With  $h = 0.1$ , we obtain the values

	$n = 2$	$n = 4$	$n = 6$	$n = 8$	$n = 10$
$t_n$	0.2	0.4	0.6	0.8	1.0
$x_n$	2.96225	2.34119	1.90236	1.56602	1.29768
$y_n$	1.34538	1.67121	1.97158	2.23895	2.46732

(b). Given

$$\begin{aligned} f(t, x, y) &= x(1 - 0.5x - 0.5y) \\ g(t, x, y) &= y(-0.25 + 0.5x), \end{aligned}$$

the Runge-Kutta method uses the following intermediate calculations:

$$\begin{aligned} \mathbf{k}_{n1} &= [f(t_n, x_n, y_n), g(t_n, x_n, y_n)]^T \\ \mathbf{k}_{n2} &= \left[ f\left(t_n + \frac{h}{2}, x_n + \frac{h}{2}k_{n1}^1, y_n + \frac{h}{2}k_{n1}^2\right), g\left(t_n + \frac{h}{2}, x_n + \frac{h}{2}k_{n1}^1, y_n + \frac{h}{2}k_{n1}^2\right) \right]^T \\ \mathbf{k}_{n3} &= \left[ f\left(t_n + \frac{h}{2}, x_n + \frac{h}{2}k_{n2}^1, y_n + \frac{h}{2}k_{n2}^2\right), g\left(t_n + \frac{h}{2}, x_n + \frac{h}{2}k_{n2}^1, y_n + \frac{h}{2}k_{n2}^2\right) \right]^T \\ \mathbf{k}_{n4} &= [f(t_n + h, x_n + hk_{n3}^1, y_n + hk_{n3}^2), g(t_n + h, x_n + hk_{n3}^1, y_n + hk_{n3}^2)]^T. \end{aligned}$$

With  $h = 0.2$ , we obtain the values:

	$n = 1$	$n = 2$	$n = 3$	$n = 4$	$n = 5$
$t_n$	0.2	0.4	0.6	0.8	1.0
$x_n$	3.06339	2.44497	1.9911	1.63818	1.3555
$y_n$	1.34858	1.68638	2.00036	2.27981	2.5175

(c). With  $h = 0.1$ , we obtain

	$n = 2$	$n = 4$	$n = 6$	$n = 8$	$n = 10$
$t_n$	0.2	0.4	0.6	0.8	1.0
$x_n$	3.06314	2.44465	1.99075	1.63781	1.35514
$y_n$	1.34899	1.68699	2.00107	2.28057	2.51827

6(a). The Euler formula gives

$$\begin{aligned} x_{n+1} &= x_n + h[\exp(-x_n + y_n) - \cos x_n] \\ y_{n+1} &= y_n + h[\sin(x_n - 3y_n)]. \end{aligned}$$

With  $h = 0.1$ , we obtain the values

	$n = 2$	$n = 4$	$n = 6$	$n = 8$	$n = 10$
$t_n$	0.2	0.4	0.6	0.8	1.0
$x_n$	1.42386	1.82234	2.21728	2.61118	2.9955
$y_n$	2.18957	2.36791	2.53329	2.68763	2.83354

(b). The Runge-Kutta method uses the following intermediate calculations:

$$\begin{aligned} \mathbf{k}_{n1} &= [f(t_n, x_n, y_n), g(t_n, x_n, y_n)]^T \\ \mathbf{k}_{n2} &= \left[ f\left(t_n + \frac{h}{2}, x_n + \frac{h}{2}k_{n1}^1, y_n + \frac{h}{2}k_{n1}^2\right), g\left(t_n + \frac{h}{2}, x_n + \frac{h}{2}k_{n1}^1, y_n + \frac{h}{2}k_{n1}^2\right) \right]^T \\ \mathbf{k}_{n3} &= \left[ f\left(t_n + \frac{h}{2}, x_n + \frac{h}{2}k_{n2}^1, y_n + \frac{h}{2}k_{n2}^2\right), g\left(t_n + \frac{h}{2}, x_n + \frac{h}{2}k_{n2}^1, y_n + \frac{h}{2}k_{n2}^2\right) \right]^T \\ \mathbf{k}_{n4} &= [f(t_n + h, x_n + hk_{n3}^1, y_n + hk_{n3}^2), g(t_n + h, x_n + hk_{n3}^1, y_n + hk_{n3}^2)]^T. \end{aligned}$$

With  $h = 0.2$ , we obtain the values:

	$n = 1$	$n = 2$	$n = 3$	$n = 4$	$n = 5$
$t_n$	0.2	0.4	0.6	0.8	1.0
$x_n$	1.41513	1.81208	2.20635	2.59826	2.97806
$y_n$	2.18699	2.36233	2.5258	2.6794	2.82487

(c). With  $h = 0.1$ , we obtain

	$n = 2$	$n = 4$	$n = 6$	$n = 8$	$n = 10$
$t_n$	0.2	0.4	0.6	0.8	1.0
$x_n$	1.41513	1.81209	2.20635	2.59826	2.97806
$y_n$	2.18699	2.36233	2.52581	2.67941	2.82488

7. The Runge-Kutta method uses the following intermediate calculations:

$$\begin{aligned} \mathbf{k}_{n1} &= [x_n - 4y_n, -x_n + y_n]^T \\ \mathbf{k}_{n2} &= \left[ x_n + \frac{h}{2}k_{n1}^1 - 4\left(y_n + \frac{h}{2}k_{n1}^2\right), -\left(x_n + \frac{h}{2}k_{n1}^1\right) + y_n + \frac{h}{2}k_{n1}^2 \right]^T \\ \mathbf{k}_{n3} &= \left[ x_n + \frac{h}{2}k_{n2}^1 - 4\left(y_n + \frac{h}{2}k_{n2}^2\right), -\left(x_n + \frac{h}{2}k_{n2}^1\right) + y_n + \frac{h}{2}k_{n2}^2 \right]^T \\ \mathbf{k}_{n4} &= [x_n + hk_{n3}^1 - 4(y_n + hk_{n3}^2), -(x_n + hk_{n3}^1) + y_n + hk_{n3}^2]^T. \end{aligned}$$

Using  $h = 0.04$ , we obtain the following values:

	$n = 5$	$n = 10$	$n = 15$	$n = 20$	$n = 25$
$t_n$	0.2	0.4	0.6	0.8	1.0
$x_n$	1.3204	1.9952	3.2992	5.7362	10.227
$y_n$	-0.25085	-0.66245	-1.3752	-2.6435	-4.9294

The exact solution is given by

$$\phi(t) = \frac{e^{-t} + e^{3t}}{2}, \quad \psi(t) = \frac{e^{-t} - e^{3t}}{4},$$

and the associated tabulated values:

	$n = 5$	$n = 10$	$n = 15$	$n = 20$	$n = 25$
$t_n$	0.2	0.4	0.6	0.8	1.0
$\phi(t_n)$	1.3204	1.9952	3.2992	5.7362	10.227
$\psi(t_n)$	-0.25085	-0.66245	-1.3752	-2.6435	-4.9294

8. Let  $y = x'$ . The second order ODE can be transformed into the first order system

$$\begin{aligned}x' &= y \\y' &= t - 3x - t^2y,\end{aligned}$$

with initial conditions  $x(0) = 1$ ,  $y(0) = 2$ . Given

$$\begin{aligned}f(t, x, y) &= y \\g(t, x, y) &= t - 3x - t^2y,\end{aligned}$$

the Runge-Kutta method uses the following intermediate calculations:

$$\begin{aligned}\mathbf{k}_{n1} &= [y_n, t_n - 3x_n - t_n^2 y_n]^T \\ \mathbf{k}_{n2} &= \left[ y_n + \frac{h}{2}k_{n1}^2, g\left(t_n + \frac{h}{2}, x_n + \frac{h}{2}k_{n1}^1, y_n + \frac{h}{2}k_{n1}^2\right) \right]^T \\ \mathbf{k}_{n3} &= \left[ y_n + \frac{h}{2}k_{n2}^2, g\left(t_n + \frac{h}{2}, x_n + \frac{h}{2}k_{n2}^1, y_n + \frac{h}{2}k_{n2}^2\right) \right]^T \\ \mathbf{k}_{n4} &= [y_n + hk_{n3}^2, g(t_n + h, x_n + hk_{n3}^1, y_n + hk_{n3}^2)]^T.\end{aligned}$$

With  $h = 0.1$ , we obtain the following values:

	$n = 5$	$n = 10$
$t_n$	0.5	1.0
$x_n$	1.543	0.07075
$y_n$	1.14743	-1.3885

9. The *predictor* formulas are

$$\begin{aligned}x_{n+1} &= x_n + \frac{h}{24}(55f_n - 59f_{n-1} + 37f_{n-2} - 9f_{n-3}) \\ y_{n+1} &= y_n + \frac{h}{24}(55g_n - 59g_{n-1} + 37g_{n-2} - 9g_{n-3}).\end{aligned}$$

With  $f_{n+1} = x_{n+1} - 4y_{n+1}$  and  $g_{n+1} = -x_{n+1} + y_{n+1}$ , the *corrector* formulas are

$$\begin{aligned}x_{n+1} &= x_n + \frac{h}{24}(9f_{n+1} + 19f_n - 5f_{n-1} + f_{n-2}) \\ y_{n+1} &= y_n + \frac{h}{24}(9g_{n+1} + 19g_n - 5g_{n-1} + g_{n-2}).\end{aligned}$$

We use the starting values from the *exact solution* :

	$n = 0$	$n = 1$	$n = 2$	$n = 3$
$t_n$	0	0.1	0.2	0.3
$x_n$	1.0	1.12883	1.32042	1.60021
$y_n$	0.0	- 0.11057	- 0.250847	- 0.429696

One time step using the *predictor-corrector* method results in the approximate values:

	$n = 4(pre)$	$n = 4(cor)$
$t_n$	0.4	0.4
$x_n$	1.99445	1.99521
$y_n$	- 0.662064	- 0.662442



## Chapter Nine

### Section 9.1

2(a). Setting  $\mathbf{x} = \boldsymbol{\xi} e^{rt}$  results in the algebraic equations

$$\begin{pmatrix} 5-r & -1 \\ 3 & 1-r \end{pmatrix} \begin{pmatrix} \xi_1 \\ \xi_2 \end{pmatrix} = \begin{pmatrix} 0 \\ 0 \end{pmatrix}.$$

For a nonzero solution, we must have  $\det(\mathbf{A} - r\mathbf{I}) = r^2 - 6r + 8 = 0$ . The roots of the characteristic equation are  $r_1 = 2$  and  $r_2 = 4$ . For  $r = 2$ , the system of equations reduces to  $3\xi_1 = \xi_2$ . The corresponding eigenvector is  $\boldsymbol{\xi}^{(1)} = (1, 3)^T$ . Substitution of  $r = 4$  results in the single equation  $\xi_1 = \xi_2$ . A corresponding eigenvector is  $\boldsymbol{\xi}^{(2)} = (1, 1)^T$ .

(b). The eigenvalues are *real* and *positive*, hence the critical point is an *unstable node*.

(c, d).

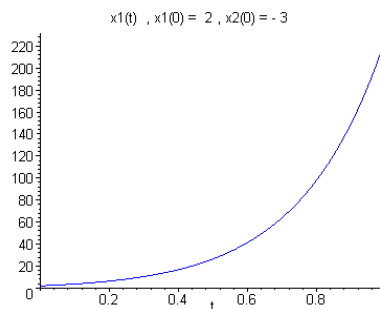
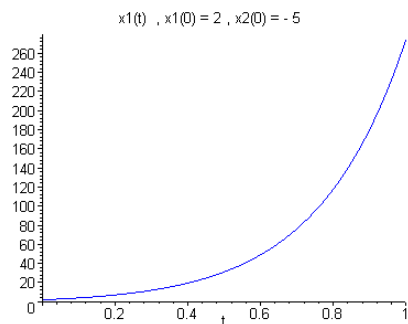
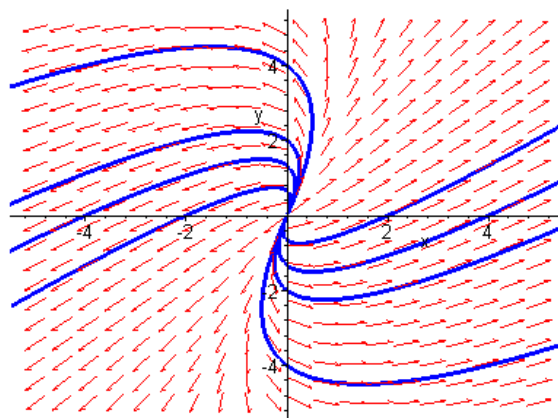

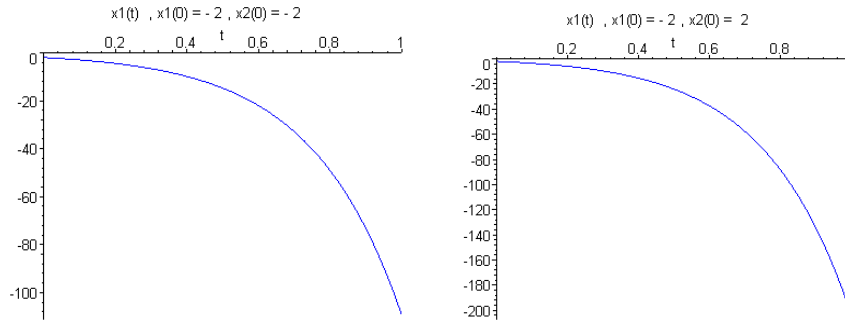

3(a). Solution of the ODE requires analysis of the algebraic equations

$$\begin{pmatrix} 2 - r & -1 \\ 3 & -2 - r \end{pmatrix} \begin{pmatrix} \xi_1 \\ \xi_2 \end{pmatrix} = \begin{pmatrix} 0 \\ 0 \end{pmatrix}.$$

For a nonzero solution, we must have  $\det(\mathbf{A} - r\mathbf{I}) = r^2 - 1 = 0$ . The roots of the characteristic equation are  $r_1 = 1$  and  $r_2 = -1$ . For  $r = 1$ , the system of equations reduces to  $\xi_1 = \xi_2$ . The corresponding eigenvector is  $\boldsymbol{\xi}^{(1)} = (1, 1)^T$ . Substitution of  $r = -1$  results in the single equation  $3\xi_1 - \xi_2 = 0$ . A corresponding eigenvector is  $\boldsymbol{\xi}^{(2)} = (1, 3)^T$ .

(b). The eigenvalues are *real*, with  $r_1 r_2 < 0$ . Hence the critical point is a *saddle*.

(c, d).

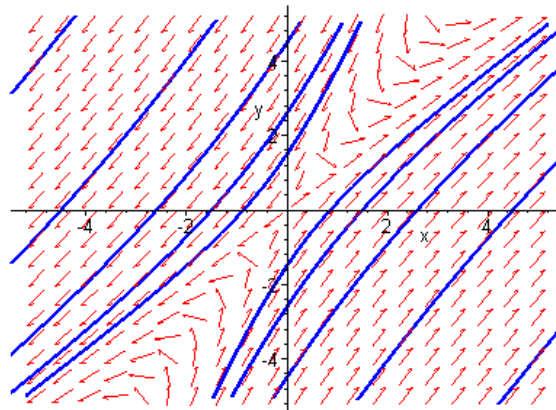

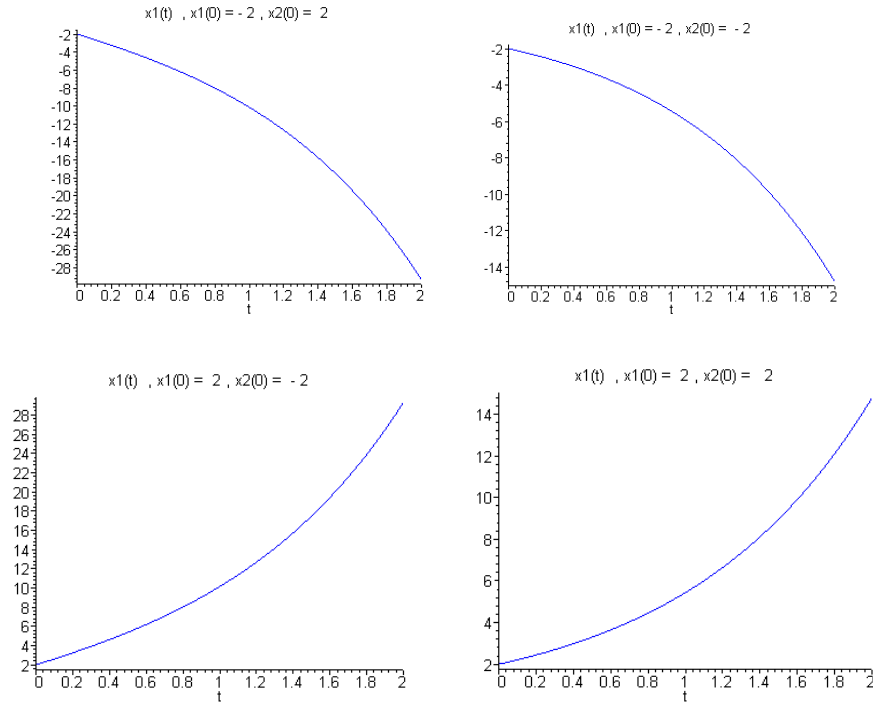

5(a). The characteristic equation is given by

$$\begin{vmatrix} 1 - r & -5 \\ 1 & -3 - r \end{vmatrix} = r^2 + 2r + 2 = 0.$$

The equation has *complex roots*  $r_1 = -1 + i$  and  $r_2 = -1 - i$ . For  $r = -1 + i$ , the components of the solution vector must satisfy  $\xi_1 - (2 + i)\xi_2 = 0$ . Thus the corresponding eigenvector is  $\boldsymbol{\xi}^{(1)} = (2 + i, 1)^T$ . Substitution of  $r = -1 - i$  results in the single equation  $\xi_1 - (2 - i)\xi_2 = 0$ . A corresponding eigenvector is  $\boldsymbol{\xi}^{(2)} = (2 - i, 1)^T$ .

(b). The eigenvalues are *complex conjugates*, with negative real part. Hence the origin is a *stable spiral*.

(c, d).

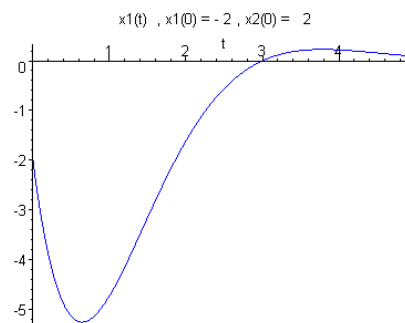
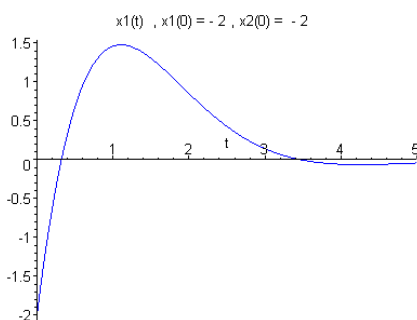
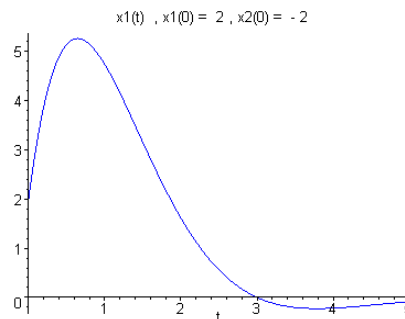
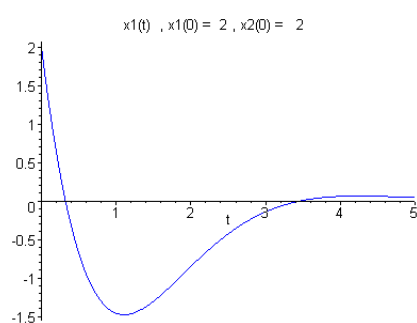
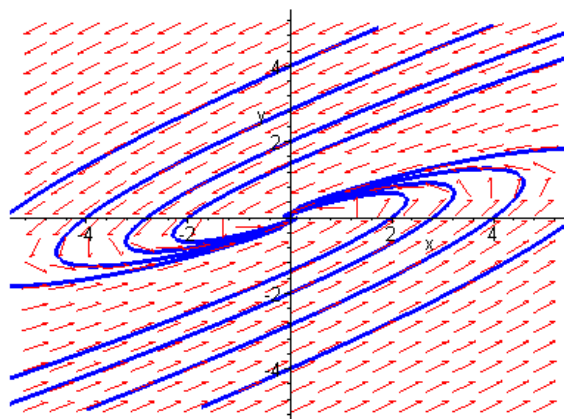

6(a). Solution of the ODEs is based on the analysis of the algebraic equations

$$\begin{pmatrix} 2 - r & -5 \\ 1 & -2 - r \end{pmatrix} \begin{pmatrix} \xi_1 \\ \xi_2 \end{pmatrix} = \begin{pmatrix} 0 \\ 0 \end{pmatrix}.$$

For a nonzero solution, we require that  $\det(\mathbf{A} - r\mathbf{I}) = r^2 + 1 = 0$ . The roots of the characteristic equation are  $r = \pm i$ . Setting  $r = i$ , the equations are equivalent to  $\xi_1 - (2 + i)\xi_2 = 0$ . The eigenvectors are  $\boldsymbol{\xi}^{(1)} = (2 + i, 1)^T$  and  $\boldsymbol{\xi}^{(2)} = (2 - i, 1)^T$ .

(b). The eigenvalues are *purely imaginary*. Hence the critical point is a *center*.

(c, d).

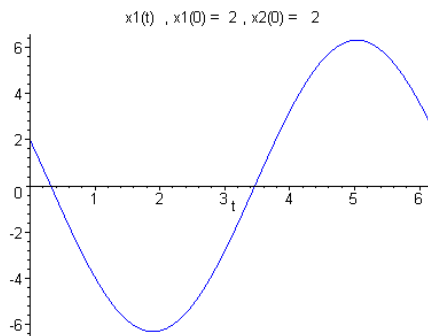
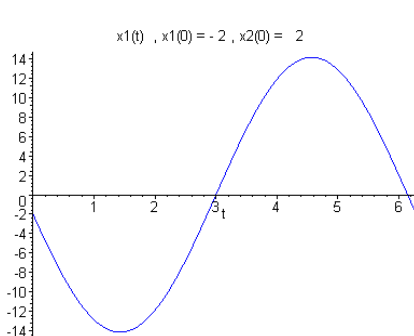
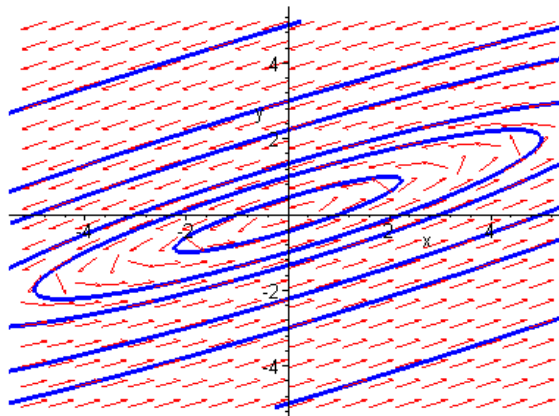

7(a). Setting  $\mathbf{x} = \boldsymbol{\xi} e^{rt}$  results in the algebraic equations

$$\begin{pmatrix} 3-r & -2 \\ 4 & -1-r \end{pmatrix} \begin{pmatrix} \xi_1 \\ \xi_2 \end{pmatrix} = \begin{pmatrix} 0 \\ 0 \end{pmatrix}.$$

For a nonzero solution, we require that  $\det(\mathbf{A} - r\mathbf{I}) = r^2 - 2r + 5 = 0$ . The roots of the characteristic equation are  $r = 1 \pm 2i$ . Substituting  $r = 1 - 2i$ , the two equations reduce to  $(1+i)\xi_1 - \xi_2 = 0$ . The two eigenvectors are  $\boldsymbol{\xi}^{(1)} = (1, 1+i)^T$  and  $\boldsymbol{\xi}^{(2)} = (1, 1-i)^T$ .

(b). The eigenvalues are *complex conjugates*, with positive real part. Hence the origin is an *unstable spiral*.

(c, d).

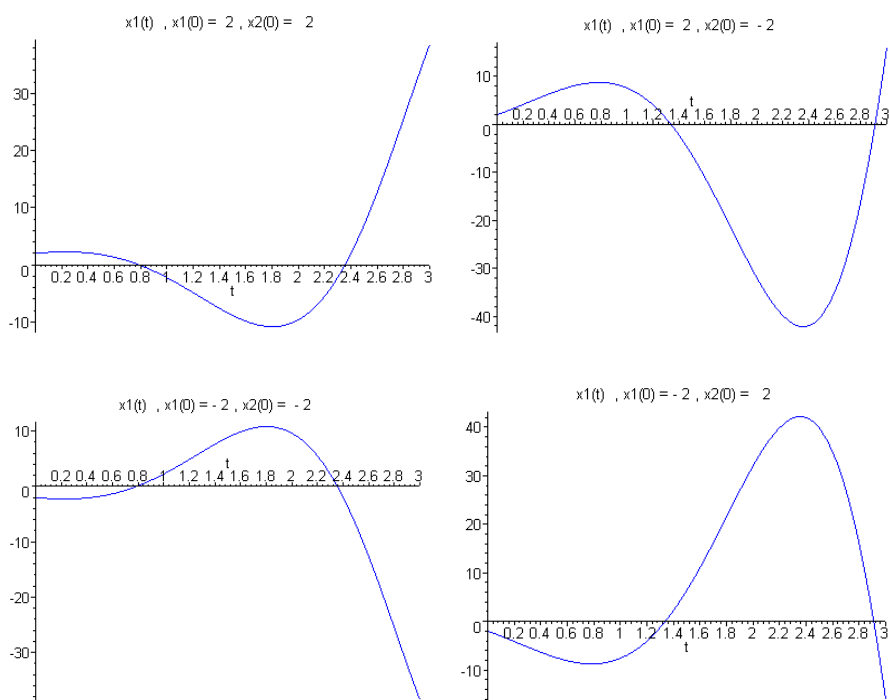
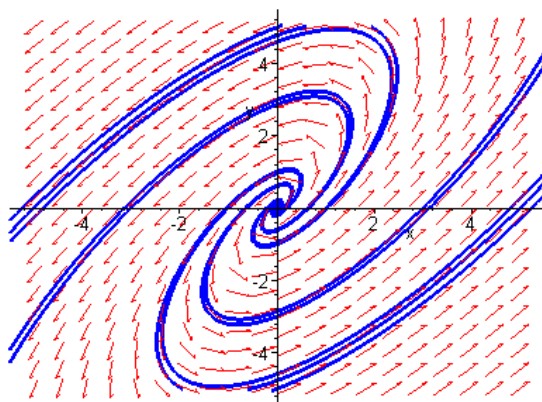

8(a). The characteristic equation is given by

$$\begin{vmatrix} 1-r & -5 \\ 1 & -3-r \end{vmatrix} = (r+1)(r+0.25) = 0,$$

with roots  $r_1 = -1$  and  $r_2 = -0.25$ . For  $r = -1$ , the components of the solution vector must satisfy  $\xi_2 = 0$ . Thus the corresponding eigenvector is  $\xi^{(1)} = (1, 0)^T$ . Substitution of  $r = -0.25$  results in the single equation  $0.75\xi_1 + \xi_2 = 0$ . A corresponding eigenvector is  $\xi^{(2)} = (4, -3)^T$ .

(b). The eigenvalues are *real* and both *negative*. Hence the critical point is a *stable*

node.

(c, d).

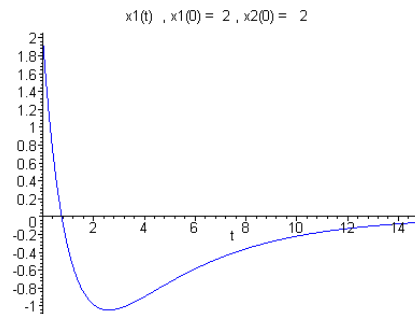
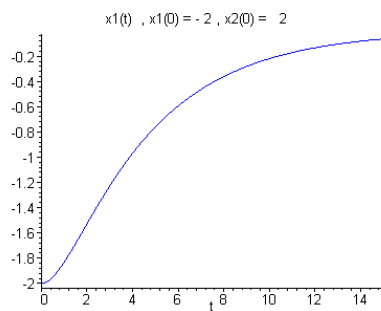
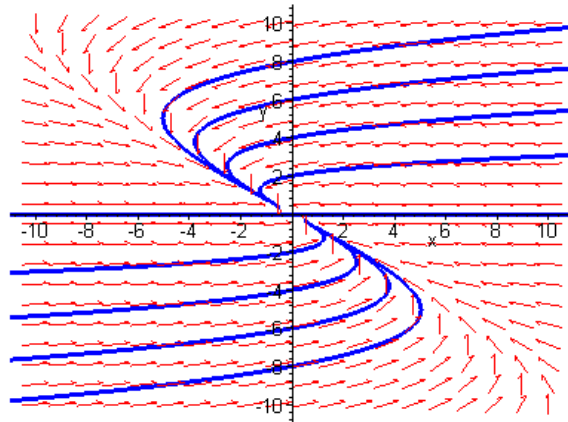

9(a). Solution of the ODEs is based on the analysis of the algebraic equations

$$\begin{pmatrix} 3 - r & -4 \\ 1 & -1 - r \end{pmatrix} \begin{pmatrix} \xi_1 \\ \xi_2 \end{pmatrix} = \begin{pmatrix} 0 \\ 0 \end{pmatrix}.$$

For a nonzero solution, we require that  $\det(\mathbf{A} - r\mathbf{I}) = r^2 - 2r + 1 = 0$ . The single root of the characteristic equation is  $r = 1$ . Setting  $r = 1$ , the components of the solution vector must satisfy  $\xi_1 - 2\xi_2 = 0$ . A corresponding eigenvector is  $\boldsymbol{\xi} = (2, 1)^T$ .

(b). Since there is only one linearly independent eigenvector, the critical point is an *unstable, improper node*.

(c, d).

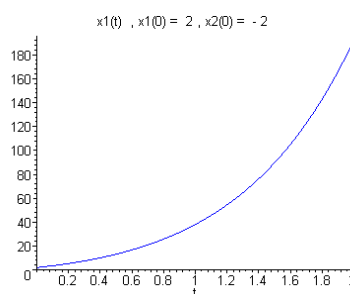
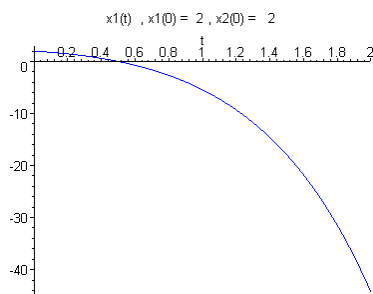
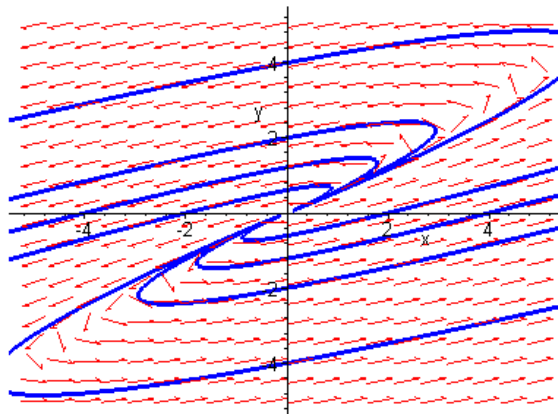

10(a). The characteristic equation is given by

$$\begin{vmatrix} 1-r & 2 \\ -5 & -1-r \end{vmatrix} = r^2 + 9 = 0.$$

The equation has *complex* roots  $r_{1,2} = \pm 3i$ . For  $r = -3i$ , the components of the solution vector must satisfy  $5\xi_1 + (1-3i)\xi_2 = 0$ . Thus the corresponding eigenvector is  $\xi^{(1)} = (1-3i, -5)^T$ . Substitution of  $r = 3i$  results in  $5\xi_1 + (1+3i)\xi_2 = 0$ . A corresponding eigenvector is  $\xi^{(2)} = (1+3i, -5)^T$ .

(b). The eigenvalues are *purely imaginary*, hence the critical point is a *center*.



(c, d).

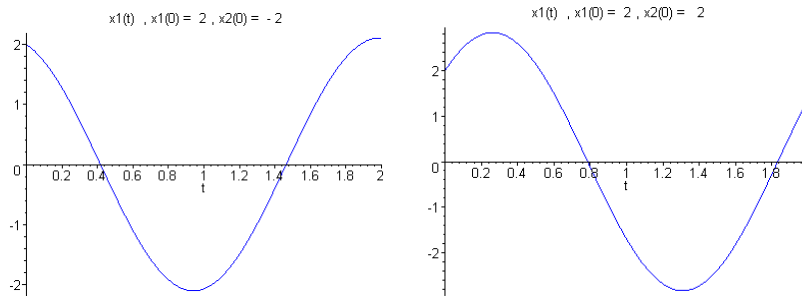
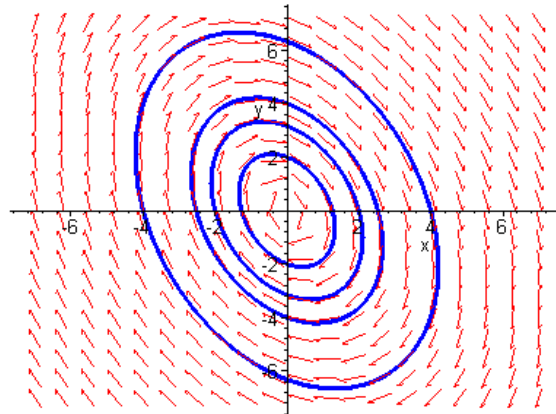

11(a). The characteristic equation is  $(r + 1)^2 = 0$ , with double root  $r = -1$ . It is easy to see that the two linearly independent eigenvectors are  $\xi^{(1)} = (1, 0)^T$  and  $\xi^{(2)} = (0, 1)^T$ .

(b). Since there are two linearly independent eigenvectors, the critical point is a *stable proper node*.

(c, d).

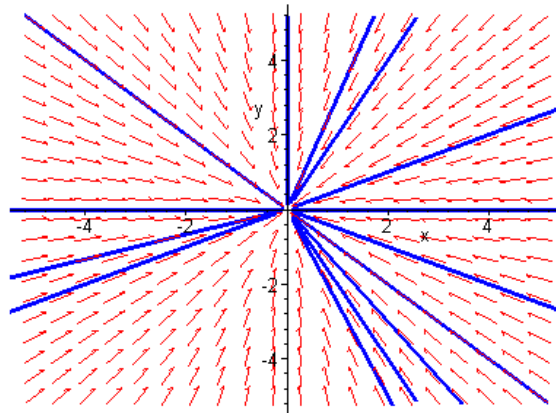

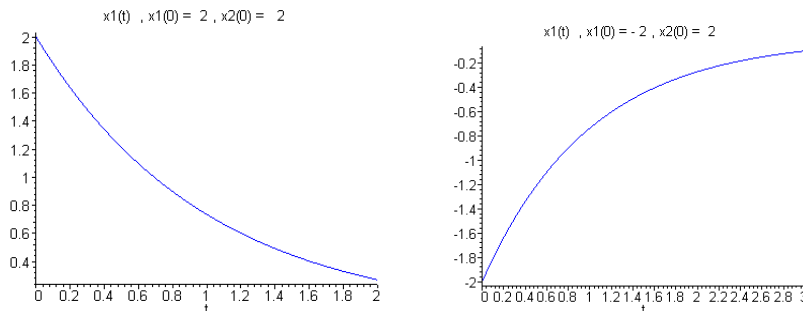

12(a). Setting  $\mathbf{x} = \boldsymbol{\xi} e^{rt}$  results in the algebraic equations

$$\begin{pmatrix} 2 - r & -5/2 \\ 9/5 & -1 - r \end{pmatrix} \begin{pmatrix} \xi_1 \\ \xi_2 \end{pmatrix} = \begin{pmatrix} 0 \\ 0 \end{pmatrix}.$$

For a nonzero solution, we require that  $\det(\mathbf{A} - r\mathbf{I}) = r^2 - r + 5/2 = 0$ . The roots of the characteristic equation are  $r = 1/2 \pm 3i/2$ . Substituting  $r = 1/2 - 3i/2$ , the equations reduce to  $(3 + 3i)\xi_1 - 5\xi_2 = 0$ . Therefore the two eigenvectors are  $\boldsymbol{\xi}^{(1)} = (5, 3 + 3i)^T$  and  $\boldsymbol{\xi}^{(2)} = (5, 3 - 3i)^T$ .

(b). Since the eigenvalues are *complex*, with *positive* real part, the critical point is an *unstable spiral*.

(c, d).

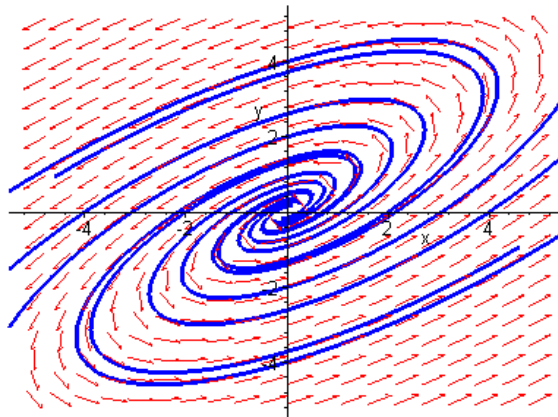

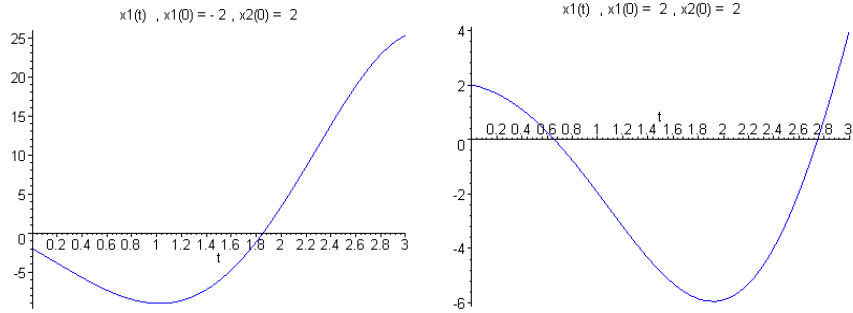

14. Setting  $\mathbf{x}' = \mathbf{0}$ , that is,

$$\begin{pmatrix} -2 & 1 \\ 1 & -2 \end{pmatrix} \mathbf{x} = \begin{pmatrix} 2 \\ -1 \end{pmatrix},$$

we find that the critical point is  $\mathbf{x}^0 = (-1, 0)^T$ . With the change of dependent variable,  $\mathbf{x} = \mathbf{x}^0 + \mathbf{u}$ , the differential equation can be written as

$$\frac{d\mathbf{u}}{dt} = \begin{pmatrix} -2 & 1 \\ 1 & -2 \end{pmatrix} \mathbf{u}.$$

The critical point for the transformed equation is the origin. Setting  $\mathbf{u} = \boldsymbol{\xi} e^{rt}$  results in the algebraic equations

$$\begin{pmatrix} -2 - r & 1 \\ 1 & -2 - r \end{pmatrix} \begin{pmatrix} \xi_1 \\ \xi_2 \end{pmatrix} = \begin{pmatrix} 0 \\ 0 \end{pmatrix}.$$

For a nonzero solution, we require that  $\det(\mathbf{A} - r\mathbf{I}) = r^2 + 4r + 3 = 0$ . The roots of the characteristic equation are  $r = -3, -1$ . Hence the critical point is a *stable node*.

15. Setting  $\mathbf{x}' = \mathbf{0}$ , that is,

$$\begin{pmatrix} -1 & -1 \\ 2 & -1 \end{pmatrix} \mathbf{x} = \begin{pmatrix} 1 \\ -5 \end{pmatrix},$$

we find that the critical point is  $\mathbf{x}^0 = (-2, 1)^T$ . With the change of dependent variable,  $\mathbf{x} = \mathbf{x}^0 + \mathbf{u}$ , the differential equation can be written as

$$\frac{d\mathbf{u}}{dt} = \begin{pmatrix} -1 & -1 \\ 2 & -1 \end{pmatrix} \mathbf{u}.$$

The characteristic equation is  $\det(\mathbf{A} - r\mathbf{I}) = r^2 + 2r + 3 = 0$ , with complex conjugate roots  $r = -1 \pm i\sqrt{2}$ . Since the real parts of the eigenvalues are *negative*, the critical point is a *stable spiral*.

16. The critical point  $\mathbf{x}^0$  satisfies the system of equations

$$\begin{pmatrix} 0 & -\beta \\ \delta & 0 \end{pmatrix} \mathbf{x} = \begin{pmatrix} -\alpha \\ \gamma \end{pmatrix}.$$

It follows that  $x^0 = \gamma/\delta$  and  $y^0 = \alpha/\beta$ . Using the transformation,  $\mathbf{x} = \mathbf{x}^0 + \mathbf{u}$ , the differential equation can be written as

$$\frac{d\mathbf{u}}{dt} = \begin{pmatrix} 0 & -\beta \\ \delta & 0 \end{pmatrix} \mathbf{u}.$$

The characteristic equation is  $\det(\mathbf{A} - r\mathbf{I}) = r^2 + \beta\delta = 0$ . Since  $\beta\delta > 0$ , the roots are purely imaginary, with  $r = \pm i\sqrt{\beta\delta}$ . Hence the critical point is a *center*.

20. The system of ODEs can be written as

$$\frac{d\mathbf{x}}{dt} = \begin{pmatrix} a_{11} & a_{12} \\ a_{21} & a_{22} \end{pmatrix} \mathbf{x}.$$

The characteristic equation is  $r^2 - pr + q = 0$ . The roots are given by

$$r_{1,2} = \frac{p \pm \sqrt{p^2 - 4q}}{2} = \frac{p \pm \sqrt{\Delta}}{2}.$$

The results can be verified using Table 9.1.1.

21(a). If  $q > 0$  and  $p < 0$ , then the roots are either complex conjugates with negative real parts, or both real and negative.

(b). If  $q > 0$  and  $p = 0$ , then the roots are purely imaginary.

(c). If  $q < 0$ , then the roots are real, with  $r_1 \cdot r_2 > 0$ . If  $p > 0$ , then either the roots are real, with  $r_1 \cdot r_2 \geq 0$  or the roots are complex conjugates with positive real parts.

### Section 9.2

2. The differential equations can be combined to obtain a related ODE

$$\frac{dy}{dx} = -\frac{2y}{x}.$$

The equation is *separable*, with

$$\frac{dy}{y} = -\frac{2 dx}{x}.$$

The solution is given by  $y = C x^{-2}$ . Note that the system is *uncoupled*, and hence we also have  $x = x_0 e^{-t}$  and  $y = y_0 e^{2t}$ .

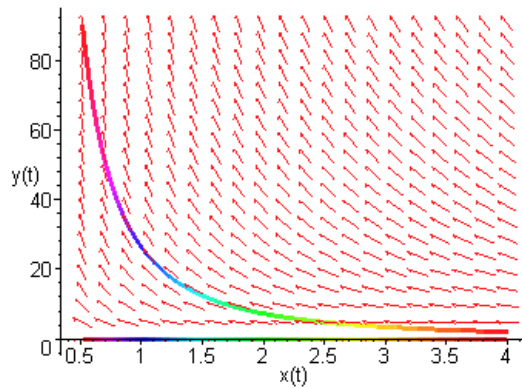

In order to determine the direction of motion along the trajectories, observe that for *positive* initial conditions,  $x$  will *decrease*, whereas  $y$  will *increase*.

4. The trajectories of the system satisfy the ODE

$$\frac{dy}{dx} = -\frac{bx}{ay}.$$

The equation is *separable*, with

$$ay dy = -bx dx.$$

Hence the trajectories are given by  $bx^2 + ay^2 = C^2$ , in which  $C$  is arbitrary. Evidently, the trajectories are *ellipses*. Invoking the initial condition, we find that  $C^2 = ab$ . The system of ODEs can also be written as

$$\frac{d\mathbf{x}}{dt} = \begin{pmatrix} 0 & a \\ -b & 0 \end{pmatrix} \mathbf{x}.$$

Using the methods in Chapter 7, it is easy to show that

$$\begin{aligned} x &= \sqrt{a} \cos \sqrt{ab} t \\ y &= -\sqrt{b} \sin \sqrt{ab} t. \end{aligned}$$

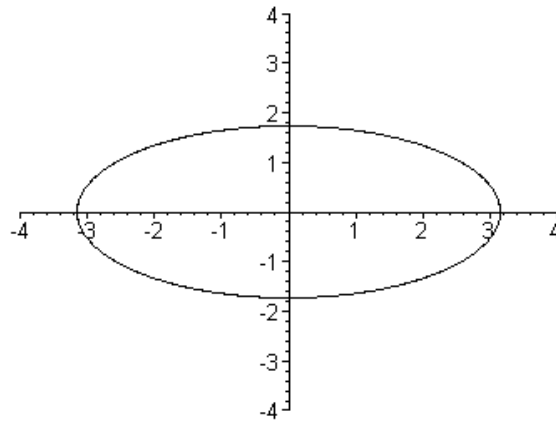

Note that for *positive* initial conditions,  $x$  will *increase*, whereas  $y$  will *decrease*.

5(a). The critical points are given by the solution set of the equations

$$\begin{aligned}x(1 - y) &= 0 \\y(1 + 2x) &= 0.\end{aligned}$$

Clearly,  $(0, 0)$  is a solution. If  $x \neq 0$ , then  $y = 1$  and  $x = -1/2$ . Hence the critical points are  $(0, 0)$  and  $(-1/2, 1)$ .

(b).

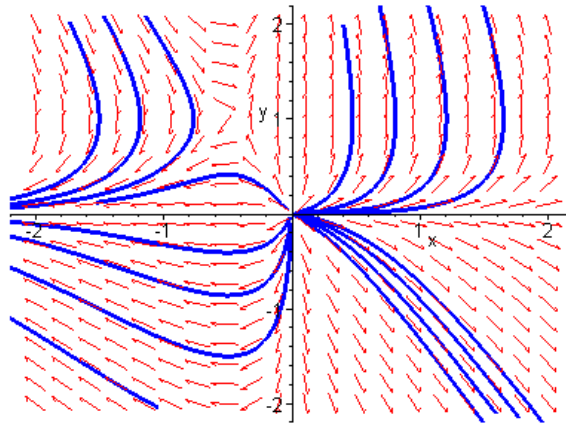

(c). Based on the phase portrait, all trajectories starting near the origin *diverge*. Hence the critical point  $(0, 0)$  is *unstable*. Examining the phase curves near the critical point  $(-1/2, 1)$ ,

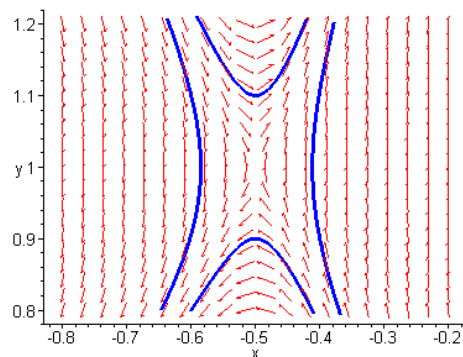

the equilibrium point has the properties of a *saddle*, and hence it is *unstable*.

6(a). The critical points are solutions of the equations

$$\begin{aligned} 1 + 2y &= 0 \\ 1 - 3x^2 &= 0. \end{aligned}$$

There are two equilibrium points,  $(-1/\sqrt{3}, -1/2)$  and  $(1/\sqrt{3}, -1/2)$ .

(b).

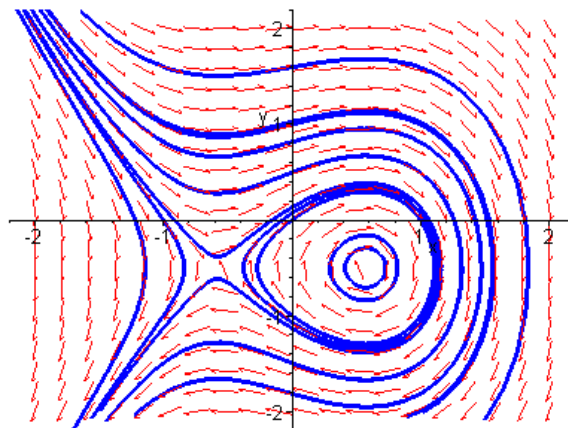

(c). Locally, the trajectories near the point  $(-1/\sqrt{3}, -1/2)$  resemble the behavior near a *saddle*. Hence the critical point is *unstable*. Near the point  $(1/\sqrt{3}, -1/2)$ , the solutions are *periodic*. Therefore the second critical point is *stable*.

8(a). The critical points are solutions of the equations

$$\begin{aligned} -(x - y)(1 - x - y) &= 0 \\ x(2 + y) &= 0. \end{aligned}$$

If  $x = y$ , then  $x = y = 0$  or  $x = y = -2$ . If  $x = 1 - y$ , then  $x = 0$  and  $y = 1$ , or  $x = 3$  and  $y = -2$ . It follows that the critical points are  $(0, 0)$ ,  $(-2, -2)$ ,  $(0, 1)$

and  $(3, -2)$ .

(b).

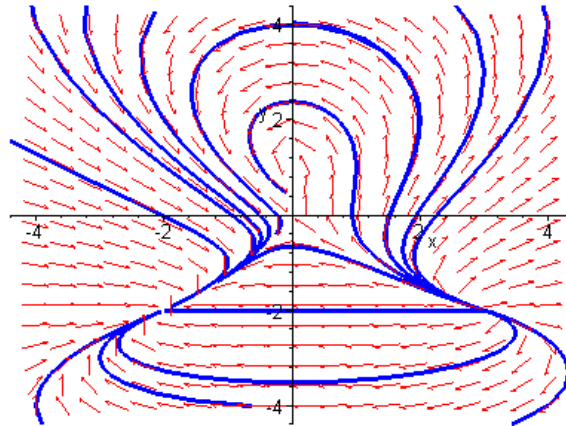

(c). Near the origin, the trajectories resemble those of a *saddle*, and hence it is *unstable*.

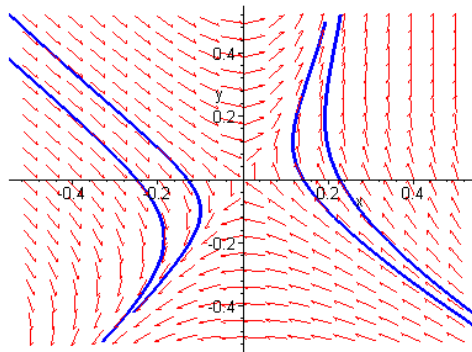

Near the critical point  $(0, 1)$ , the trajectories resemble those of a *stable spiral*. Hence the equilibrium point is *asymptotically stable*.

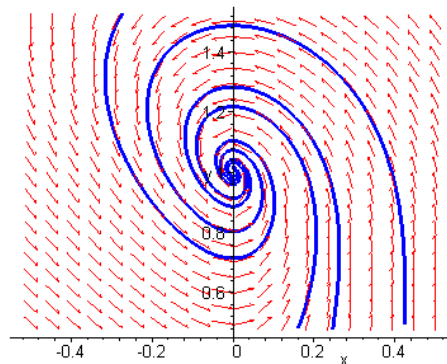

Based on the global phase portrait, it is evident that the other critical points are *nodes*. Closer examination reveals that the point  $(-2, -2)$  is *asymptotically stable*, whereas the point  $(3, -2)$  is *unstable*.



9(a). The critical points are given by the solution set of the equations

$$\begin{aligned} y(2 - x - y) &= 0 \\ -x - y - 2xy &= 0. \end{aligned}$$

Clearly,  $(0, 0)$  is a critical point. If  $x = 2 - y$ , then it follows that  $y(y - 2) = 1$ . The additional critical points are  $(1 - \sqrt{2}, 1 + \sqrt{2})$  and  $(1 + \sqrt{2}, 1 - \sqrt{2})$ .

(b).

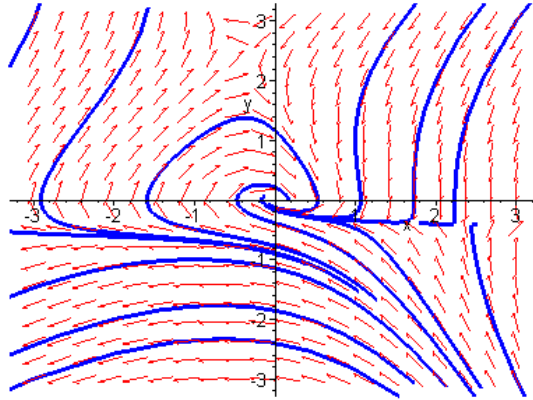

(c). The behavior near the origin is that of a *stable spiral*. Hence the point  $(0, 0)$  is *asymptotically stable*.

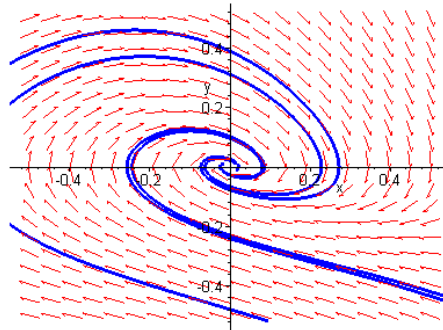

At the critical point  $(1 - \sqrt{2}, 1 + \sqrt{2})$ , the trajectories resemble those near a *saddle*. Hence the critical point is *unstable*.

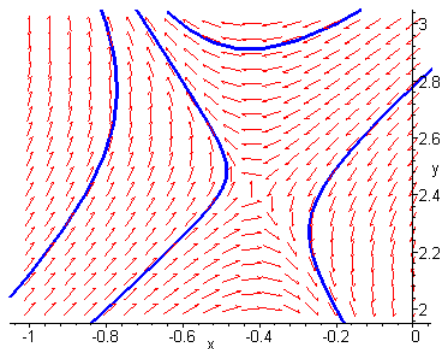

Near the point  $(1 + \sqrt{2}, 1 - \sqrt{2})$ , the trajectories resemble those near a *saddle*. Hence the critical point is also *unstable*.

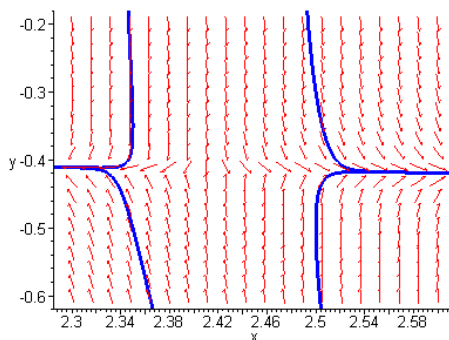

10(a). The critical points are solutions of the equations

$$\begin{aligned}(2 + x)(y - x) &= 0 \\ y(2 + x - x^2) &= 0.\end{aligned}$$

The origin is evidently a critical point. If  $x = -2$ , then  $y = 0$ . If  $x = y$ , then either  $y = 0$  or  $x = y = -1$  or  $x = y = 2$ . Hence the other critical points are  $(-2, 0)$ ,  $(-1, -1)$  and  $(2, 2)$ .

(b).

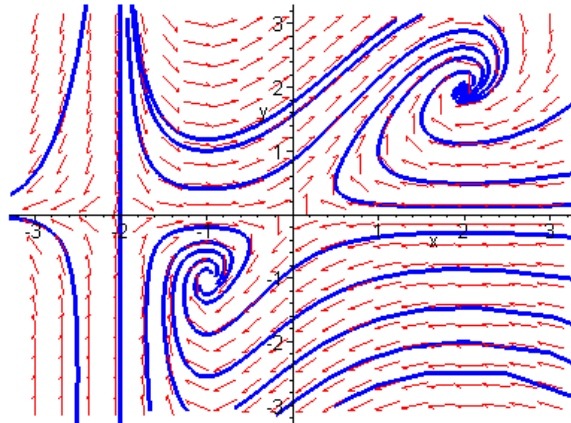

(c). Based on the global phase portrait, the critical points  $(0, 0)$  and  $(-2, 0)$  have the characteristics of a *saddle*. Hence these points are *unstable*. The behavior near the remaining two critical points resembles those near a *stable spiral*. Hence the critical points  $(-1, -1)$  and  $(2, 2)$  are *asymptotically stable*.

11(a). The critical points are given by the solution set of the equations

$$\begin{aligned} x(1 - 2y) &= 0 \\ y - x^2 - y^2 &= 0. \end{aligned}$$

If  $x = 0$ , then either  $y = 0$  or  $y = 1$ . If  $y = 1/2$ , then  $x = \pm 1/2$ . Hence the critical points are at  $(0, 0)$ ,  $(0, 1)$ ,  $(-1/2, 1/2)$  and  $(1/2, 1/2)$ .

(b).

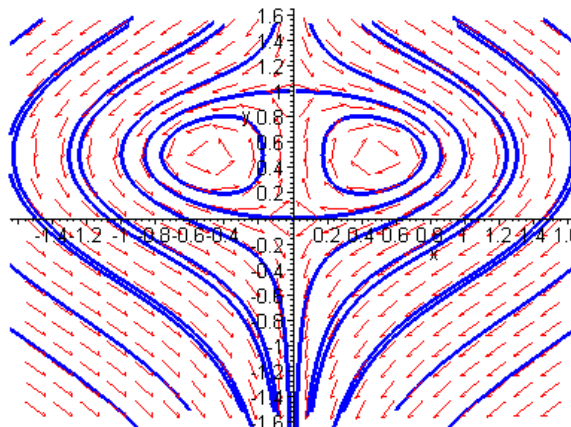

(c). The trajectories near the critical points  $(-1/2, 1/2)$  and  $(1/2, 1/2)$  are closed curves. Hence the critical points have the characteristics of a *center*, which is *stable*. The trajectories near the critical points  $(0, 0)$  and  $(0, 1)$  resemble those near a *saddle*. Hence these critical points are *unstable*.

13(a). The critical points are solutions of the equations

$$\begin{aligned}(2+x)(y-x) &= 0 \\ (4-x)(y+x) &= 0.\end{aligned}$$

If  $y = x$ , then either  $x = y = 0$  or  $x = y = 4$ . If  $x = -2$ , then  $y = 2$ . If  $x = -y$ , then  $y = 2$  or  $y = 0$ . Hence the critical points are at  $(0, 0)$ ,  $(4, 4)$  and  $(-2, 2)$ .

(b).

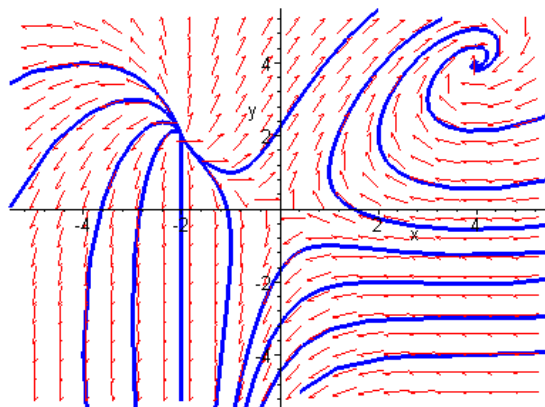

(c). The critical point at  $(4, 4)$  is evidently a *stable spiral*, which is *asymptotically stable*. Closer examination of the critical point at  $(0, 0)$  reveals that it is a *saddle*, which is *unstable*.

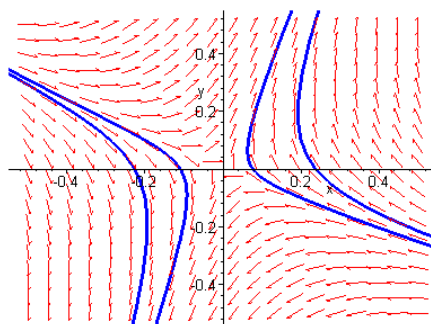

The trajectories near the critical point  $(-2, 2)$  resemble those near an *unstable node*.

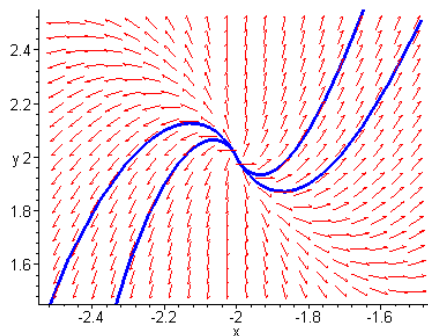

14(a). The critical points consist of the solution set of the equations

$$\begin{aligned} y &= 0 \\ (1 - x^2)y - x &= 0. \end{aligned}$$

It is easy to see that the only critical point is at  $(0, 0)$ .

(b).

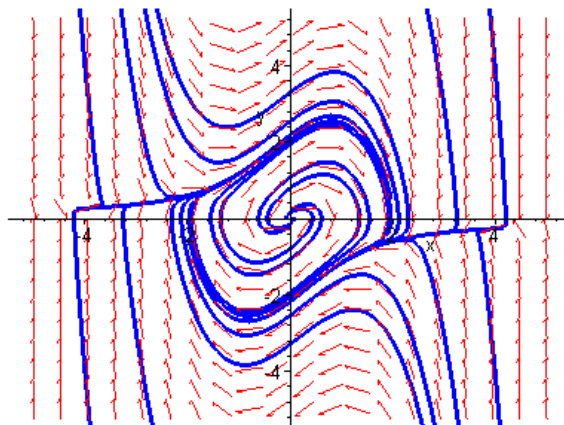

(c). The origin is an *unstable spiral*.

16(a). The trajectories are solutions of the differential equation

$$\frac{dy}{dx} = -\frac{4x}{y},$$

which can also be written as  $4x dx + y dy = 0$ . Integrating, we obtain

$$4x^2 + y^2 = C^2.$$

Hence the trajectories are ellipses.

(b).

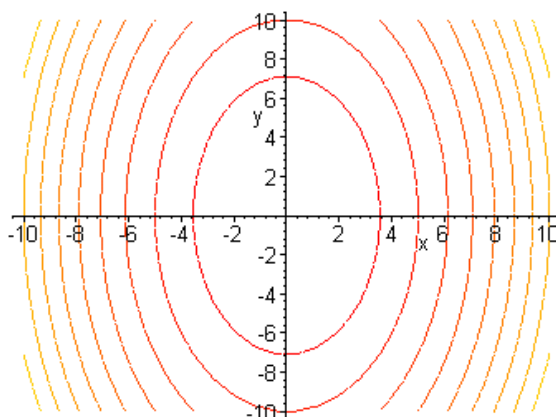

Based on the differential equations, the direction of motion on each trajectory is *clockwise*.

17(a). The trajectories of the system satisfy the ODE

$$\frac{dy}{dx} = \frac{2x + y}{y},$$

which can also be written as  $(2x + y)dx - ydy = 0$ . This differential equation is *homogeneous*. Setting  $y = xv(x)$ , we obtain

$$v + x \frac{dv}{dx} = \frac{2}{v} + 1,$$

that is,

$$x \frac{dv}{dx} = \frac{2 + v - v^2}{v}.$$

The resulting ODE is *separable*, with solution  $x^3(v + 1)(v - 2)^2 = C$ . Reverting back to the original variables, the trajectories are level curves of

$$H(x, y) = (x + y)(y - 2x)^2.$$

(b).

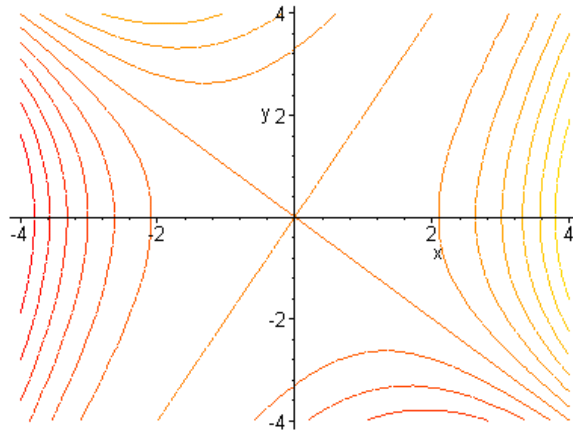

The origin is a *saddle*. Along the line  $y = 2x$ , solutions increase without bound. Along the line  $y = -x$ , solutions converge toward the origin.

18(a). The trajectories are solutions of the differential equation

$$\frac{dy}{dx} = \frac{x + y}{x - y},$$

which is *homogeneous*. Setting  $y = xv(x)$ , we obtain

$$v + x \frac{dv}{dx} = \frac{x + xv}{x - xv},$$

that is,

$$x \frac{dv}{dx} = \frac{1 + v^2}{1 - v}.$$

The resulting ODE is *separable*, with solution

$$\arctan(v) = \ln|x| \sqrt{1 + v^2}.$$

Reverting back to the original variables, the trajectories are level curves of

$$H(x, y) = \arctan(y/x) - \ln \sqrt{x^2 + y^2}.$$

(b).

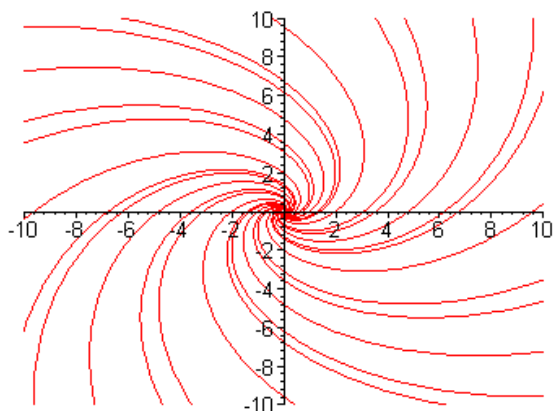

The origin is a *stable spiral*.

20(a). The trajectories are solutions of the differential equation

$$\frac{dy}{dx} = \frac{-2xy^2 + 6xy}{2x^2y - 3x^2 - 4y},$$

which can also be written as  $(2xy^2 - 6xy)dx + (2x^2y - 3x^2 - 4y)dy = 0$ . The resulting ODE is *exact*, with

$$\frac{\partial H}{\partial x} = 2xy^2 - 6xy \quad \text{and} \quad \frac{\partial H}{\partial y} = 2x^2y - 3x^2 - 4y.$$

Integrating the first equation, we find that  $H(x, y) = x^2y^2 - 3x^2y + f(y)$ . It follows that

$$\frac{\partial H}{\partial y} = 2x^2y - 3x^2 + f'(y).$$

Comparing the two partial derivatives, we obtain  $f(y) = -2y^2 + c$ . Hence

$$H(x, y) = x^2y^2 - 3x^2y - 2y^2.$$



(b).

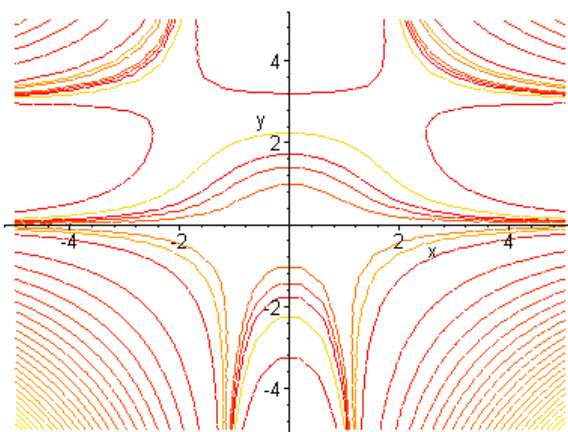

The associated direction field shows the direction of motion along the trajectories.

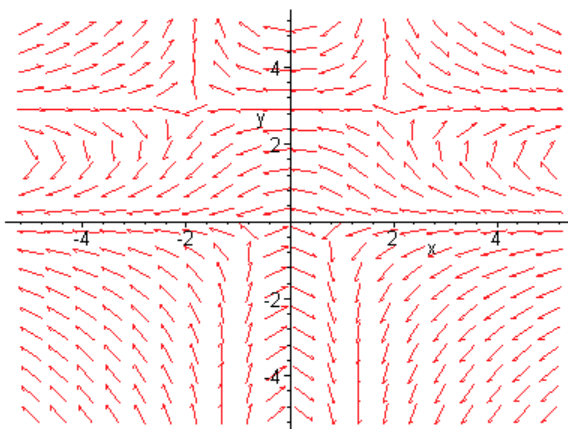

22(a). The trajectories are solutions of the differential equation

$$\frac{dy}{dx} = \frac{-6x + x^3}{6y},$$

which can also be written as  $(6x - x^3)dx + 6ydy = 0$ . The resulting ODE is *exact*, with

$$\frac{\partial H}{\partial x} = 6x - x^3 \quad \text{and} \quad \frac{\partial H}{\partial y} = 6y.$$

Integrating the first equation, we have  $H(x, y) = 3x^2 - x^4/4 + f(y)$ . It follows that

$$\frac{\partial H}{\partial y} = f'(y).$$

Comparing the two partial derivatives, we conclude that  $f(y) = 3y^2 + c$ . Hence

$$H(x, y) = 3x^2 - \frac{x^4}{4} + 3y^2.$$

(b).

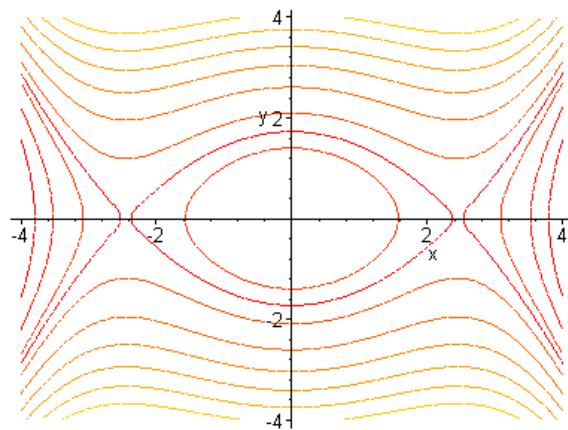

## Section 9.3

1. Write the system in the form  $\mathbf{x}' = \mathbf{A}\mathbf{x} + \mathbf{g}(\mathbf{x})$ . In this case, it is evident that

$$\frac{d}{dt} \begin{pmatrix} x \\ y \end{pmatrix} = \begin{pmatrix} 1 & 0 \\ 1 & -2 \end{pmatrix} \begin{pmatrix} x \\ y \end{pmatrix} + \begin{pmatrix} -y^2 \\ x^2 \end{pmatrix}.$$

That is,  $\mathbf{g}(\mathbf{x}) = (-y^2, x^2)^T$ . Using polar coordinates,  $\|\mathbf{g}(\mathbf{x})\| = r^2 \sqrt{\sin^4\theta + \cos^4\theta}$  and  $\|\mathbf{x}\| = r$ . Hence

$$\lim_{r \rightarrow 0} \frac{\|\mathbf{g}(\mathbf{x})\|}{\|\mathbf{x}\|} = \lim_{r \rightarrow 0} r \sqrt{\sin^4\theta + \cos^4\theta} = 0,$$

and the system is *almost linear*. The origin is an isolated critical point of the linear system

$$\frac{d}{dt} \begin{pmatrix} x \\ y \end{pmatrix} = \begin{pmatrix} 1 & 0 \\ 1 & -2 \end{pmatrix} \begin{pmatrix} x \\ y \end{pmatrix}.$$

The characteristic equation of the coefficient matrix is  $r^2 + r - 2 = 0$ , with roots  $r_1 = 1$  and  $r_2 = -2$ . Hence the critical point is a *saddle*, which is *unstable*.

2. The system can be written as

$$\frac{d}{dt} \begin{pmatrix} x \\ y \end{pmatrix} = \begin{pmatrix} -1 & 1 \\ -4 & -1 \end{pmatrix} \begin{pmatrix} x \\ y \end{pmatrix} + \begin{pmatrix} 2xy \\ x^2 - y^2 \end{pmatrix}.$$

Following the discussion in Example 3, we note that  $F(x, y) = -x + y + 2xy$  and  $G(x, y) = -4x - y + x^2 - y^2$ . Both of the functions  $F$  and  $G$  are *twice differentiable*, hence the system is *almost linear*. Furthermore,

$$F_x = -1 + 2y, \quad F_y = 1 + 2x, \quad G_x = -4 + 2x, \quad G_y = -1 - 2y.$$

The origin is an isolated critical point, with

$$\begin{pmatrix} F_x(0, 0) & F_y(0, 0) \\ G_x(0, 0) & G_y(0, 0) \end{pmatrix} = \begin{pmatrix} -1 & 1 \\ -4 & -1 \end{pmatrix}.$$

The characteristic equation of the associated linear system is  $r^2 + 2r + 5 = 0$ , with complex conjugate roots  $r_{1,2} = -1 \pm 2i$ . The origin is a *stable spiral*, which is *asymptotically stable*.

5(a). The critical points consist of the solution set of the equations

$$\begin{aligned} (2+x)(y-x) &= 0 \\ (4-x)(y+x) &= 0. \end{aligned}$$

As shown in Prob. 13 of Section 9.2, the only critical points are at  $(0, 0)$ ,  $(4, 4)$  and  $(-2, 2)$ .

(b, c). First note that  $F(x, y) = (2 + x)(y - x)$  and  $G(x, y) = (4 - x)(y + x)$ . The *Jacobian* matrix of the vector field is

$$\mathbf{J} = \begin{pmatrix} F_x(x, y) & F_y(x, y) \\ G_x(x, y) & G_y(x, y) \end{pmatrix} = \begin{pmatrix} -2 - 2x + y & 2 + x \\ 4 - y - 2x & 4 - x \end{pmatrix}.$$

At the origin, the coefficient matrix of the linearized system is

$$\mathbf{J}(0, 0) = \begin{pmatrix} -2 & 2 \\ 4 & 4 \end{pmatrix},$$

with eigenvalues  $r_1 = 1 - \sqrt{17}$  and  $r_2 = 1 + \sqrt{17}$ . The eigenvalues are real, with opposite sign. Hence the critical point is a *saddle*, which is *unstable*. At the equilibrium point  $(-2, 2)$ , the coefficient matrix of the linearized system is

$$\mathbf{J}(-2, 2) = \begin{pmatrix} 4 & 0 \\ 6 & 6 \end{pmatrix},$$

with eigenvalues  $r_1 = 4$  and  $r_2 = 6$ . The eigenvalues are real, unequal and positive, hence the critical point is an *unstable node*. At the point  $(4, 4)$ , the coefficient matrix of the linearized system is

$$\mathbf{J}(4, 4) = \begin{pmatrix} -6 & 6 \\ -8 & 0 \end{pmatrix},$$

with complex conjugate eigenvalues  $r_{1,2} = -3 \pm i\sqrt{39}$ . The critical point is a *stable spiral*, which is *asymptotically stable*.

Based on Table 9.3.1, the nonlinear terms do not affect the stability and type of each critical point.

(d).

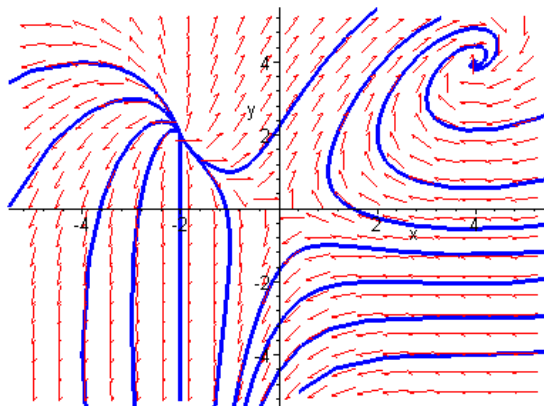

7(a). The critical points are solutions of the equations

$$\begin{aligned} 1 - y &= 0 \\ (x - y)(x + y) &= 0. \end{aligned}$$

The first equation requires that  $y = 1$ . Based on the second equation,  $x = \pm 1$ . Hence the critical points are  $(-1, 1)$  and  $(1, 1)$ .

(b, c).  $F(x, y) = 1 - y$  and  $G(x, y) = x^2 - y^2$ . The *Jacobian* matrix of the vector field is

$$\mathbf{J} = \begin{pmatrix} F_x(x, y) & F_y(x, y) \\ G_x(x, y) & G_y(x, y) \end{pmatrix} = \begin{pmatrix} 0 & -1 \\ 2x & -2y \end{pmatrix}.$$

At the critical point  $(-1, 1)$ , the coefficient matrix of the linearized system is

$$\mathbf{J}(-1, 1) = \begin{pmatrix} 0 & -1 \\ -2 & -2 \end{pmatrix},$$

with eigenvalues  $r_1 = -1 - \sqrt{3}$  and  $r_2 = -1 + \sqrt{3}$ . The eigenvalues are real, with opposite sign. Hence the critical point is a *saddle*, which is *unstable*. At the equilibrium point  $(1, 1)$ , the coefficient matrix of the linearized system is

$$\mathbf{J}(1, 1) = \begin{pmatrix} 0 & -1 \\ 2 & -2 \end{pmatrix},$$

with complex conjugate eigenvalues  $r_{1,2} = -1 \pm i$ . The critical point is a *stable spiral*, which is *asymptotically stable*.

(d).

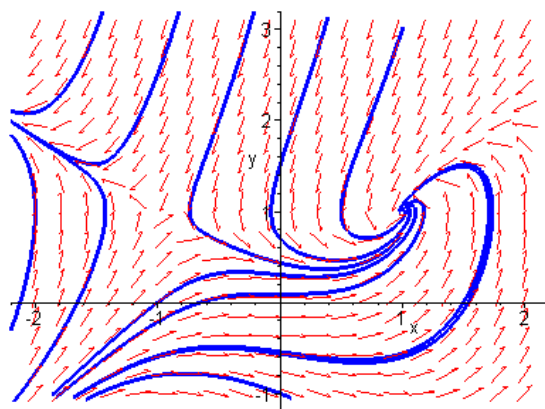

Based on Table 9.3.1, the nonlinear terms do not affect the stability and type of each critical point.

8(a). The critical points are given by the solution set of the equations

$$\begin{aligned}x(1 - x - y) &= 0 \\y(2 - y - 3x) &= 0.\end{aligned}$$

If  $x = 0$ , then either  $y = 0$  or  $y = 2$ . If  $y = 0$ , then  $x = 0$  or  $x = 1$ . If  $y = 1 - x$ , then either  $x = 1/2$  or  $x = 1$ . If  $y = 2 - 3x$ , then  $x = 0$  or  $x = 1/2$ . Hence the critical points are at  $(0, 0)$ ,  $(0, 2)$ ,  $(1, 0)$  and  $(1/2, 1/2)$ .

$(b, c)$ . Note that  $F(x, y) = x - x^2 - xy$  and  $G(x, y) = (2y - y^2 - 3xy)/4$ . The *Jacobian* matrix of the vector field is

$$\mathbf{J} = \begin{pmatrix} F_x(x, y) & F_y(x, y) \\ G_x(x, y) & G_y(x, y) \end{pmatrix} = \begin{pmatrix} 1 - 2x - y & -x \\ -3y/4 & 1/2 - y/2 - 3x/4 \end{pmatrix}.$$

At the origin, the coefficient matrix of the linearized system is

$$\mathbf{J}(0, 0) = \begin{pmatrix} 1 & 0 \\ 0 & \frac{1}{2} \end{pmatrix},$$

with eigenvalues  $r_1 = 1$  and  $r_2 = 1/2$ . The eigenvalues are real and both positive. Hence the critical point is an *unstable node*. At the equilibrium point  $(0, 2)$ , the coefficient matrix of the linearized system is

$$\mathbf{J}(0, 2) = \begin{pmatrix} -1 & 0 \\ -\frac{3}{2} & -\frac{1}{2} \end{pmatrix},$$

with eigenvalues  $r_1 = -1$  and  $r_2 = -1/2$ . The eigenvalues are both negative, hence the critical point is a *stable node*. At the point  $(1, 0)$ , the coefficient matrix of the linearized system is

$$\mathbf{J}(1, 0) = \begin{pmatrix} -1 & -1 \\ 0 & -\frac{1}{4} \end{pmatrix},$$

with eigenvalues  $r_1 = -1$  and  $r_2 = -1/4$ . Both of the eigenvalues are negative, and hence the critical point is a *stable node*. At the critical point  $(1/2, 1/2)$ , the coefficient matrix of the linearized system is

$$\mathbf{J}(1/2, 1/2) = \begin{pmatrix} -\frac{1}{2} & -\frac{1}{2} \\ -\frac{3}{8} & -\frac{1}{8} \end{pmatrix},$$

with eigenvalues  $r_1 = -5/16 - \sqrt{57}/16$  and  $r_2 = -5/16 + \sqrt{57}/16$ . The eigenvalues are real, with opposite sign. Hence the critical point is a *saddle*, which is *unstable*.

(d).

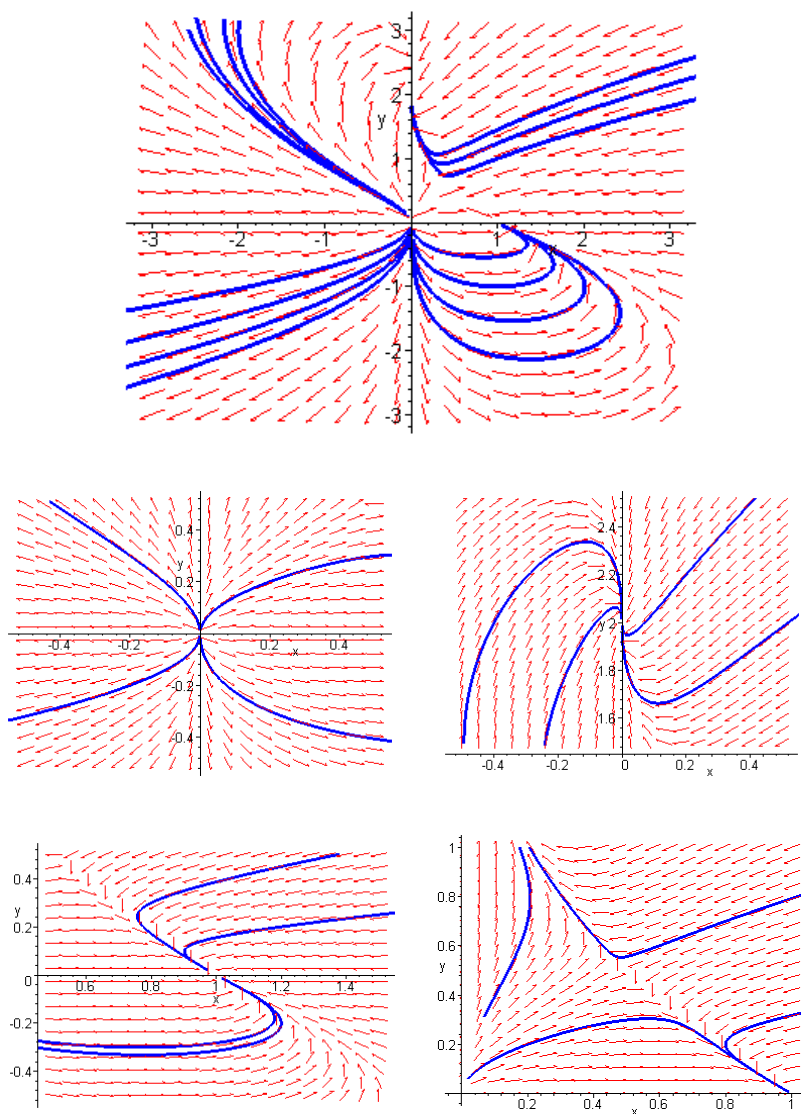

Based on Table 9.3.1, the nonlinear terms do not affect the stability and type of each critical point.

9(a). Based on Prob. 8, in Section 9.2, the critical points are at  $(0, 0)$ ,  $(-2, -2)$ ,  $(0, 1)$  and  $(3, -2)$ .

(b, c). First note that  $F(x, y) = -(x - y)(1 - x - y)$  and  $G(x, y) = x(2 + y)$ . The *Jacobian* matrix of the vector field is

$$\mathbf{J} = \begin{pmatrix} 2x - 1 & 1 - 2y \\ 2 + y & x \end{pmatrix}.$$

At the origin, the coefficient matrix of the linearized system is

$$\mathbf{J}(0,0) = \begin{pmatrix} -1 & 1 \\ 2 & 0 \end{pmatrix},$$

with eigenvalues  $r_1 = 1$  and  $r_2 = -2$ . The eigenvalues are real, with opposite sign. Hence the critical point is a *saddle*, which is *unstable*. At the critical point  $(0, 1)$ , the coefficient matrix of the linearized system is

$$\mathbf{J}(0,1) = \begin{pmatrix} -1 & -1 \\ 3 & 0 \end{pmatrix},$$

with complex conjugate eigenvalues  $r_{1,2} = -1/2 \pm i\sqrt{11}/2$ . The critical point is a *stable spiral*, which is *asymptotically stable*. At the point  $(-2, -2)$ , the coefficient matrix of the linearized system is

$$\mathbf{J}(-2, -2) = \begin{pmatrix} -5 & 5 \\ 0 & -2 \end{pmatrix},$$

with eigenvalues  $r_1 = -2$  and  $r_2 = -5$ . The eigenvalues are unequal and negative, hence the critical point is a *stable node*. At the point  $(3, -2)$ , the coefficient matrix of the linearized system is

$$\mathbf{J}(3, -2) = \begin{pmatrix} 5 & 5 \\ 0 & 3 \end{pmatrix},$$

with eigenvalues  $r_1 = 3$  and  $r_2 = 5$ . The eigenvalues are unequal and positive, hence the critical point is an *unstable node*.

(d).

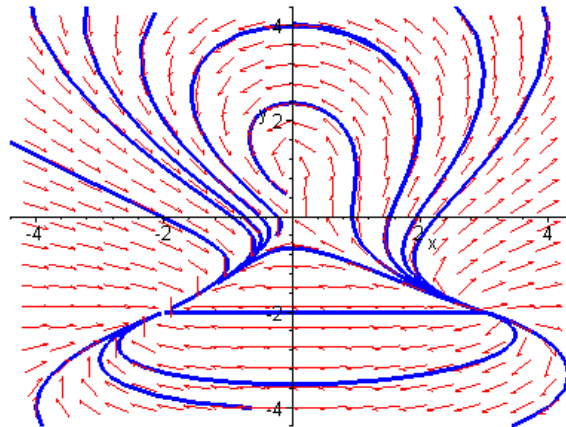

Based on Table 9.3.1, the nonlinear terms do not affect the stability and type of each critical point.



11(a). The critical points are solutions of the equations

$$\begin{aligned}2x + y + xy^3 &= 0 \\ x - 2y - xy &= 0.\end{aligned}$$

Substitution of  $y = x/(x + 2)$  into the first equation results in

$$3x^4 + 13x^3 + 28x^2 + 20x = 0.$$

One root of the resulting equation is  $x = 0$ . The only other real root of the equation is

$$x = \frac{1}{9} \left[ \left( 287 + 18\sqrt{2019} \right)^{1/3} - 83 \left( 287 + 18\sqrt{2019} \right)^{-1/3} - 13 \right].$$

Hence the critical points are  $(0, 0)$  and  $(-1.19345\dots, 1.4797\dots)$ .

(b, c).  $F(x, y) = x - x^2 - xy$  and  $G(x, y) = (2y - y^2 - 3xy)/4$ . The *Jacobian* matrix of the vector field is

$$\mathbf{J} = \begin{pmatrix} F_x(x, y) & F_y(x, y) \\ G_x(x, y) & G_y(x, y) \end{pmatrix} = \begin{pmatrix} 2 + y^3 & 1 + 3xy^2 \\ 1 - y & -2 - x \end{pmatrix}.$$

At the origin, the coefficient matrix of the linearized system is

$$\mathbf{J}(0, 0) = \begin{pmatrix} 2 & 1 \\ 1 & -2 \end{pmatrix},$$

with eigenvalues  $r_1 = \sqrt{5}$  and  $r_2 = -\sqrt{5}$ . The eigenvalues are real and of opposite sign. Hence the critical point is a *saddle*, which is *unstable*. At the equilibrium point  $(-1.19345\dots, 1.4797\dots)$ , the coefficient matrix of the linearized system is

$$\mathbf{J}(-1.19345, 1.4797) = \begin{pmatrix} -1.2399 & -6.8393 \\ -2.4797 & -0.8065 \end{pmatrix},$$

with complex conjugate eigenvalues  $r_{1,2} = -1.0232 \pm 4.1125i$ . The critical point is a *stable spiral*, which is *asymptotically stable*.

(d).

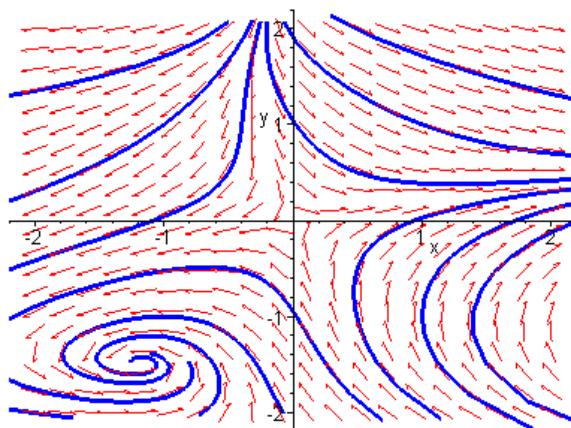

In both cases, the nonlinear terms do not affect the stability and type of the critical point.

12(a). The critical points are given by the solution set of the equations

$$\begin{aligned}(1+x)\sin y &= 0 \\ 1-x-\cos y &= 0.\end{aligned}$$

If  $x = -1$ , then we must have  $\cos y = 2$ , which is impossible. Therefore  $\sin y = 0$ , which implies that  $y = n\pi$ ,  $n = 0, \pm 1, 2, \dots$ . Based on the second equation,

$$x = 1 - \cos n\pi.$$

It follows that the critical points are located at  $(0, 2k\pi)$  and  $(2, (2k+1)\pi)$ , where  $k = 0, \pm 1, 2, \dots$ .

(b, c). Given that  $F(x, y) = (1+x)\sin y$  and  $G(x, y) = 1-x-\cos y$ , the Jacobian matrix of the vector field is

$$\mathbf{J} = \begin{pmatrix} \sin y & (1+x)\cos y \\ -1 & \sin y \end{pmatrix}.$$

At the critical points  $(0, 2k\pi)$ , the coefficient matrix of the linearized system is

$$\mathbf{J}(0, 2k\pi) = \begin{pmatrix} 0 & 1 \\ -1 & 0 \end{pmatrix},$$

with purely complex eigenvalues  $r_{1,2} = \pm i$ . The critical points of the associated linear systems are *centers*, which are *stable*. Note that Theorem 9.3.2 does *not* provide a definite conclusion regarding the relation between the nature of the critical points of the nonlinear systems and their corresponding linearizations. At the points  $(2, (2k+1)\pi)$ , the coefficient matrix of the linearized system is

$$\mathbf{J}[2, (2k+1)\pi] = \begin{pmatrix} 0 & -3 \\ -1 & 0 \end{pmatrix},$$

with eigenvalues  $r_1 = \sqrt{3}$  and  $r_2 = -\sqrt{3}$ . The eigenvalues are real, with opposite sign. Hence the critical points of the associated linear systems are *saddles*, which are *unstable*.

(d).

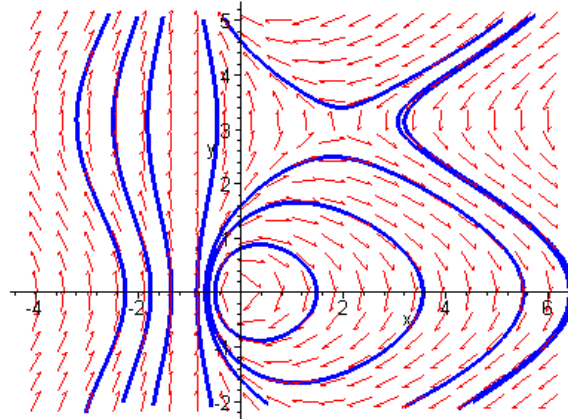

As asserted in Theorem 9.3.2, the trajectories near the critical points  $(2, (2k + 1)\pi)$  resemble those near a saddle.

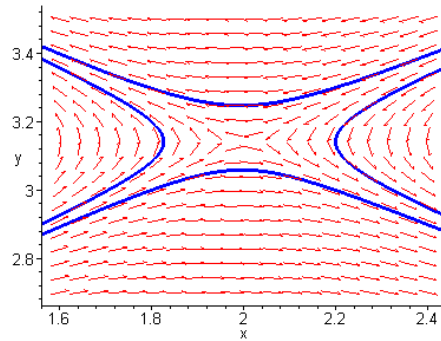

Upon closer examination, the critical points  $(0, 2k\pi)$  are indeed centers.

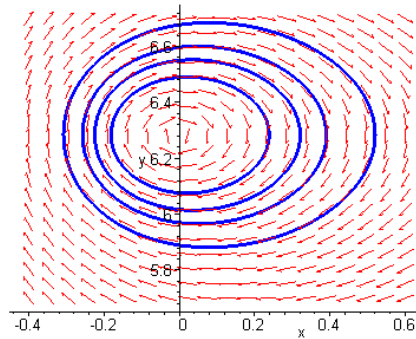

13(a). The critical points are solutions of the equations

$$\begin{aligned}x - y^2 &= 0 \\y - x^2 &= 0.\end{aligned}$$

Substitution of  $y = x^2$  into the first equation results in

$$x - x^4 = 0,$$

with real roots  $x = 0, 1$ . Hence the critical points are at  $(0, 0)$  and  $(1, 1)$ .

$(b, c)$ . In this problem,  $F(x, y) = x - y^2$  and  $G(x, y) = y - x^2$ . The *Jacobian* matrix of the vector field is

$$\mathbf{J} = \begin{pmatrix} 1 & -2y \\ -2x & 1 \end{pmatrix}.$$

At the origin, the coefficient matrix of the linearized system is

$$\mathbf{J}(0, 0) = \begin{pmatrix} 1 & 0 \\ 0 & 1 \end{pmatrix},$$

with *repeated* eigenvalues  $r_1 = 1$  and  $r_2 = 1$ . It is easy to see that the corresponding eigenvectors are linearly independent. Hence the critical point is an *unstable proper node*. Theorem 9.3.2 does *not* provide a definite conclusion regarding the relation between the nature of the critical point of the nonlinear system and the corresponding linearization. At the critical point  $(1, 1)$ , the coefficient matrix of the linearized system is

$$\mathbf{J}(1, 1) = \begin{pmatrix} 1 & -2 \\ -2 & 1 \end{pmatrix},$$

with eigenvalues  $r_1 = 3$  and  $r_2 = -1$ . The eigenvalues are real, with opposite sign. Hence the critical point is a *saddle*, which is *unstable*.

$(d)$ .

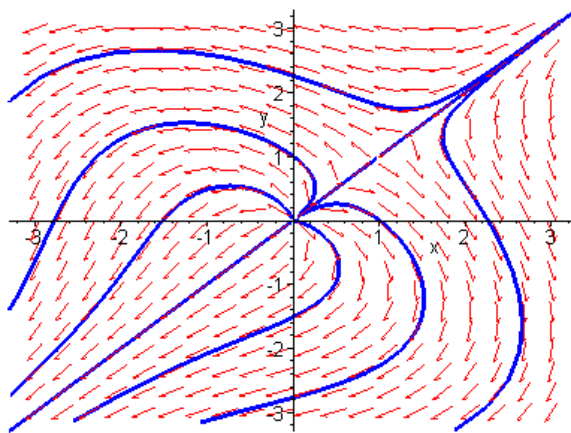

Closer examination reveals that the critical point at the origin is indeed a proper node.

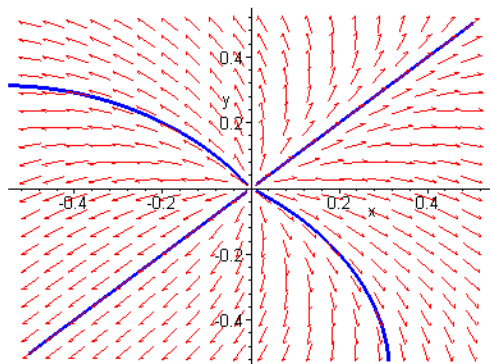

14(a). The critical points are given by the solution set of the equations

$$\begin{aligned} 1 - xy &= 0 \\ x - y^3 &= 0. \end{aligned}$$

After multiplying the second equation by  $y$ , it follows that  $y = \pm 1$ . Hence the critical points of the system are at  $(1, 1)$  and  $(-1, -1)$ .

(b, c). Note that  $F(x, y) = 1 - xy$  and  $G(x, y) = x - y^3$ . The *Jacobian* matrix of the vector field is

$$\mathbf{J} = \begin{pmatrix} -y & -x \\ 1 & -3y^2 \end{pmatrix}.$$

At the critical point  $(1, 1)$ , the coefficient matrix of the linearized system is

$$\mathbf{J}(1, 1) = \begin{pmatrix} -1 & -1 \\ 1 & -3 \end{pmatrix},$$

with eigenvalues  $r_1 = -2$  and  $r_2 = -2$ . The eigenvalues are real and *equal*. It is easy to show that there is only *one* linearly independent eigenvector. Hence the critical point is a *stable improper node*. Theorem 9.3.2 does *not* provide a definite conclusion regarding the relation between the nature of the critical point of the nonlinear system and the corresponding linearization. At the point  $(-1, -1)$ , the coefficient matrix of the linearized system is

$$\mathbf{J}(-1, -1) = \begin{pmatrix} 1 & 1 \\ 1 & -3 \end{pmatrix},$$

with eigenvalues  $r_1 = -1 + \sqrt{5}$  and  $r_2 = -1 - \sqrt{5}$ . The eigenvalues are real, with opposite sign. Hence the critical point of the associated linear system is a *saddle*, which is *unstable*.

(d).

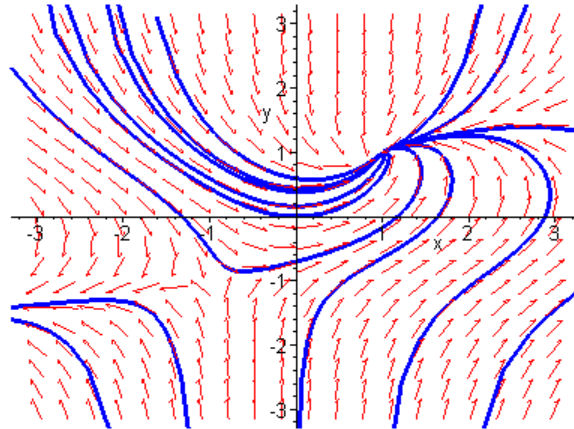

Closer examination reveals that the critical point at  $(1, 1)$  is indeed a *stable* improper node, which is asymptotically stable.

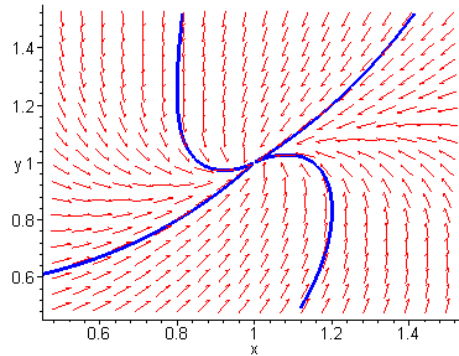

15(a). The critical points are given by the solution set of the equations

$$\begin{aligned} -2x - y - x(x^2 + y^2) &= 0 \\ x - y + y(x^2 + y^2) &= 0. \end{aligned}$$

It is clear that the origin is a critical point. Solving the *first* equation for  $y$ , we find that

$$y = \frac{-1 \pm \sqrt{1 - 8x^2 - 4x^4}}{2x}.$$

Substitution of these relations into the *second* equation results in two equations of the form  $f_1(x) = 0$  and  $f_2(x) = 0$ . Plotting these functions, we note that only  $f_1(x) = 0$  has real roots given by  $x \approx \pm 0.33076$ . It follows that the additional critical points are at  $(-0.33076, 1.0924)$  and  $(0.33076, -1.0924)$ .

(b, c). Given that

$$\begin{aligned} F(x, y) &= -2x - y - x(x^2 + y^2) \\ G(x, y) &= x - y + y(x^2 + y^2), \end{aligned}$$

the *Jacobian* matrix of the vector field is

$$\mathbf{J} = \begin{pmatrix} -2 - 3x^2 - y^2 & -1 - 2xy \\ 1 + 2xy & -1 + x^2 + 3y^2 \end{pmatrix}.$$

At the critical point  $(0, 0)$ , the coefficient matrix of the linearized system is

$$\mathbf{J}(0, 0) = \begin{pmatrix} -2 & -1 \\ 1 & -1 \end{pmatrix},$$

with complex conjugate eigenvalues  $r_{1,2} = (-3 \pm i\sqrt{3})/2$ . Hence the critical point is a *stable spiral*, which is *asymptotically stable*. At the point  $(-0.33076, 1.0924)$ , the coefficient matrix of the linearized system is

$$\mathbf{J}(-0.33076, 1.0924) = \begin{pmatrix} -3.5216 & -0.27735 \\ 0.27735 & 2.6895 \end{pmatrix},$$

with eigenvalues  $r_1 = -3.5092$  and  $r_2 = 2.6771$ . The eigenvalues are real, with opposite sign. Hence the critical point of the associated linear system is a *saddle*, which is *unstable*. Identical results hold for the point at  $(0.33076, -1.0924)$ .

(d).

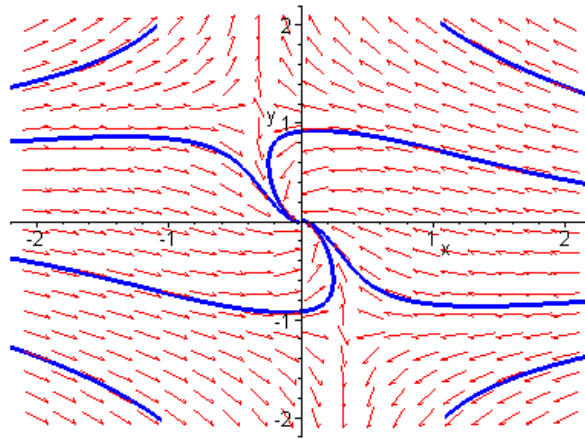

A closer look at the origin reveals a spiral:

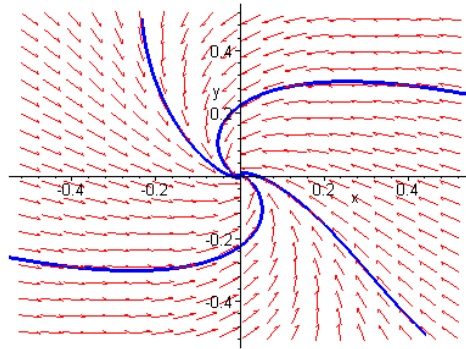

Near the point  $(0.33076, -1.0924)$  the nature of the critical point is evident:

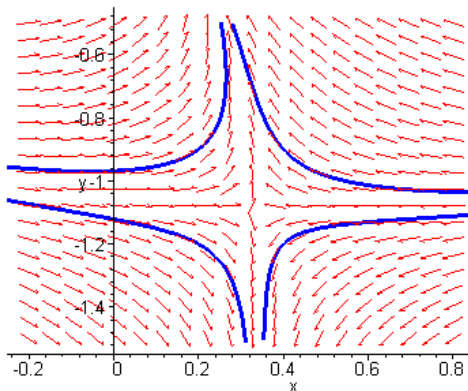

Based on Table 9.3.1, the nonlinear terms do not affect the stability and type of each critical point.

16(a). The critical points are solutions of the equations

$$\begin{aligned}y + x(1 - x^2 - y^2) &= 0 \\ -x + y(1 - x^2 - y^2) &= 0.\end{aligned}$$

Multiply the *first* equation by  $y$  and the *second* equation by  $x$ . The difference of the two equations gives  $x^2 + y^2 = 0$ . Hence the only critical point is at the origin.

(b, c). With  $F(x, y) = y + x(1 - x^2 - y^2)$  and  $G(x, y) = -x + y(1 - x^2 - y^2)$ , the *Jacobian* matrix of the vector field is

$$\mathbf{J} = \begin{pmatrix} 1 - 3x^2 - y^2 & 1 - 2xy \\ -1 - 2xy & 1 - x^2 - 3y^2 \end{pmatrix}.$$

At the origin, the coefficient matrix of the linearized system is

$$\mathbf{J}(0, 0) = \begin{pmatrix} 1 & 1 \\ -1 & 1 \end{pmatrix},$$

with complex conjugate eigenvalues  $r_{1,2} = 1 \pm i$ . Hence the origin is an *unstable*



*spiral.*

(d).

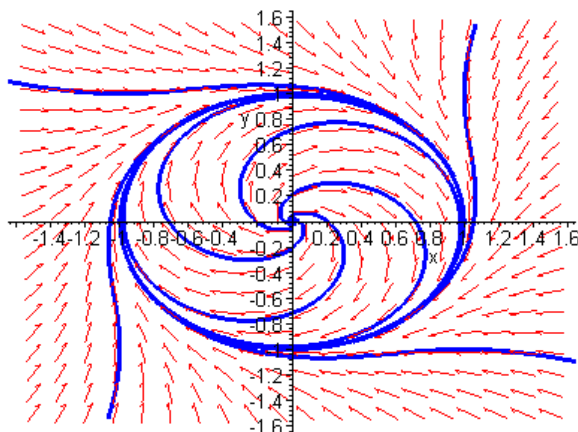

17(a). The Jacobian matrix of the vector field is

$$\mathbf{J} = \begin{pmatrix} 0 & 1 \\ 1 + 6x^2 & 0 \end{pmatrix}.$$

At the origin, the coefficient matrix of the linearized system is

$$\mathbf{J}(0, 0) = \begin{pmatrix} 1 & 0 \\ 0 & 1 \end{pmatrix},$$

with eigenvalues  $r_1 = 1$  and  $r_2 = -1$ . The eigenvalues are real, with opposite sign. Hence the critical point is a *saddle point*.

(b). The trajectories of the *linearized* system are solutions of the differential equation

$$\frac{dy}{dx} = \frac{x}{y},$$

which is separable. Integrating both sides of the equation  $x dx - y dy = 0$ , the solution is  $x^2 - y^2 = C$ . The trajectories consist of a family of hyperbolas.

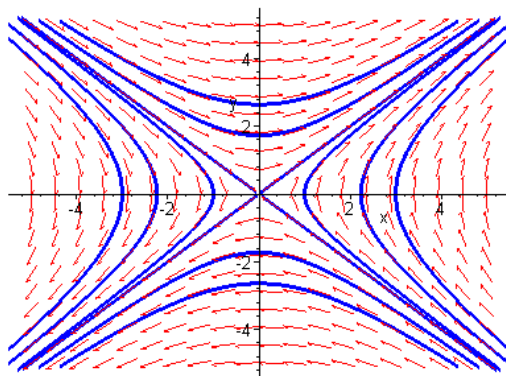

It is easy to show that the general solution is given by  $x(t) = c_1 e^t + c_2 e^{-t}$  and  $y(t) = c_1 e^t - c_2 e^{-t}$ . The only *bounded* solutions consist of those for which  $c_1 = 0$ . In that case,  $x(t) = c_2 e^{-t} = -y(t)$ .

(c). The trajectories of the given system are solutions of the differential equation

$$\frac{dy}{dx} = \frac{x + 2x^3}{y},$$

which can also be written as  $(x + 2x^3)dx - y dy = 0$ . The resulting ODE is *exact*, with

$$\frac{\partial H}{\partial x} = x + 2x^3 \quad \text{and} \quad \frac{\partial H}{\partial y} = -y.$$

Integrating the first equation, we find that  $H(x, y) = x^2/2 + x^4/2 + f(y)$ . It follows that

$$\frac{\partial H}{\partial y} = f'(y).$$

Comparing the partial derivatives, we obtain  $f(y) = -y^2/2 + c$ . Hence the solutions are level curves of the function

$$H(x, y) = x^2/2 + x^4/2 - y^2/2.$$

The trajectories *approaching* to, or *diverging* from, the origin are no longer straight lines.

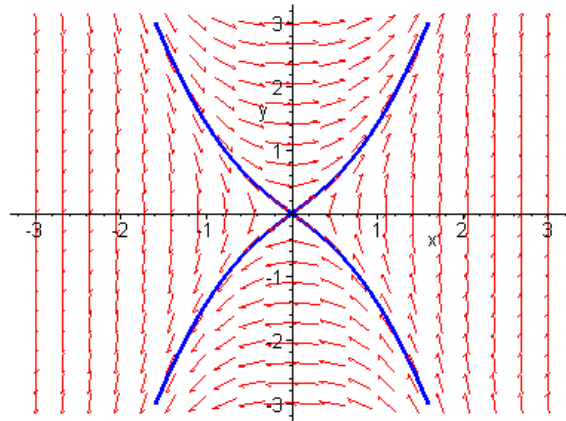

19(a). The solutions of the system of equations

$$\begin{aligned} y &= 0 \\ -\omega^2 \sin x &= 0 \end{aligned}$$

consist of the points  $(\pm n\pi, 0)$ ,  $n = 0, 1, 2, \dots$ . The functions  $F(x, y) = y$  and  $G(x, y) = -\omega^2 \sin x$  are *analytic* on the entire plane. It follows that the system is almost linear near each of the critical points.

(b). The Jacobian matrix of the vector field is

$$\mathbf{J} = \begin{pmatrix} 0 & 1 \\ -\omega^2 \cos x & 0 \end{pmatrix}.$$

At the origin, the coefficient matrix of the linearized system is

$$\mathbf{J}(0, 0) = \begin{pmatrix} 0 & 1 \\ -\omega^2 & 0 \end{pmatrix},$$

with purely complex eigenvalues  $r_{1,2} = \pm i\omega$ . Hence the origin is a *center*. Since the eigenvalues are purely complex, Theorem 9.3.2 gives no definite conclusion about the critical point of the nonlinear system. Physically, the critical point corresponds to the state  $\theta = 0$ ,  $\theta' = 0$ . That is, the rest configuration of the pendulum.

(c). At the critical point  $(\pi, 0)$ , the coefficient matrix of the linearized system is

$$\mathbf{J}(\pi, 0) = \begin{pmatrix} 0 & 1 \\ \omega^2 & 0 \end{pmatrix},$$

with eigenvalues  $r_{1,2} = \pm \omega$ . The eigenvalues are real and of opposite sign. Hence the critical point is a *saddle*. Theorem 9.3.2 asserts that the critical point for the nonlinear system is also a saddle, which is unstable. This critical point corresponds to the state  $\theta = \pi$ ,  $\theta' = 0$ . That is, the *upright* rest configuration.

(d). Let  $\omega^2 = 1$ . The following is a plot of the phase curves near  $(0, 0)$ .

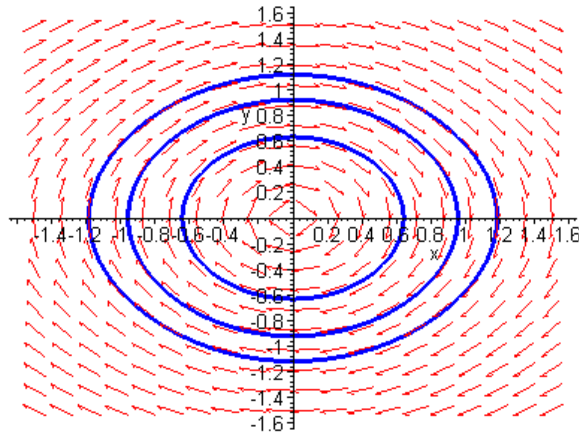

The local phase portrait shows that the origin is indeed a center.

(e).

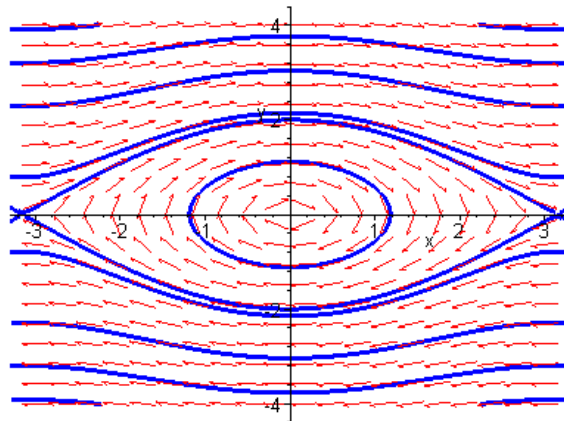

It should be noted that the phase portrait has a periodic pattern, since  $\theta = x \bmod 2\pi$ .

20(a). The trajectories of the system in Problem 19 are solutions of the differential equation

$$\frac{dy}{dx} = \frac{-\omega^2 \sin x}{y},$$

which can also be written as  $\omega^2 \sin x \, dx + y \, dy = 0$ . The resulting ODE is *exact*, with

$$\frac{\partial H}{\partial x} = \omega^2 \sin x \quad \text{and} \quad \frac{\partial H}{\partial y} = y.$$

Integrating the first equation, we find that  $H(x, y) = -\omega^2 \cos x + f(y)$ . It follows that

$$\frac{\partial H}{\partial y} = f'(y).$$

Comparing the partial derivatives, we obtain  $f(y) = y^2/2 + C$ . Hence the solutions are level curves of the function

$$H(x, y) = -\omega^2 \cos x + y^2/2.$$

Adding an arbitrary constant, say  $\omega^2$ , to the function  $H(x, y)$  does not change the nature of the level curves. Hence the trajectories are can be written as

$$\frac{1}{2}y^2 + \omega^2(1 - \cos x) = c,$$

in which  $c$  is an arbitrary constant.

(b). Multiplying by  $mL^2$  and reverting to the original physical variables, we obtain

$$\frac{1}{2}mL^2 \left( \frac{d\theta}{dt} \right)^2 + mL^2\omega^2(1 - \cos \theta) = mL^2c.$$

Since  $\omega^2 = g/L$ , the equation can be written as

$$\frac{1}{2}mL^2 \left( \frac{d\theta}{dt} \right)^2 + mgL(1 - \cos \theta) = E,$$

in which  $E = mL^2c$ .

(c). The *absolute velocity* of the point mass is given by  $v = L d\theta/dt$ . The kinetic energy of the mass is  $T = mv^2/2$ . Choosing the rest position as the *datum*, that is, the level of *zero potential energy*, the gravitational potential energy of the point mass is

$$V = mgL(1 - \cos \theta).$$

It follows that the total energy,  $T + V$ , is *constant* along the trajectories.

21(a).  $A = 0.25$

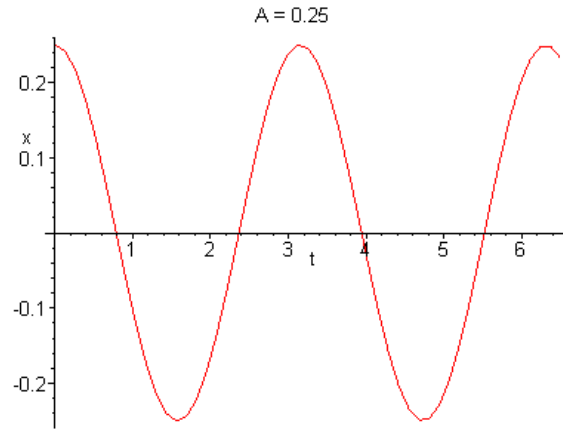

Since the system is *undamped*, and  $y(0) = 0$ , the amplitude is 0.25. The period is estimated at  $\tau \approx 3.16$ .

(b).

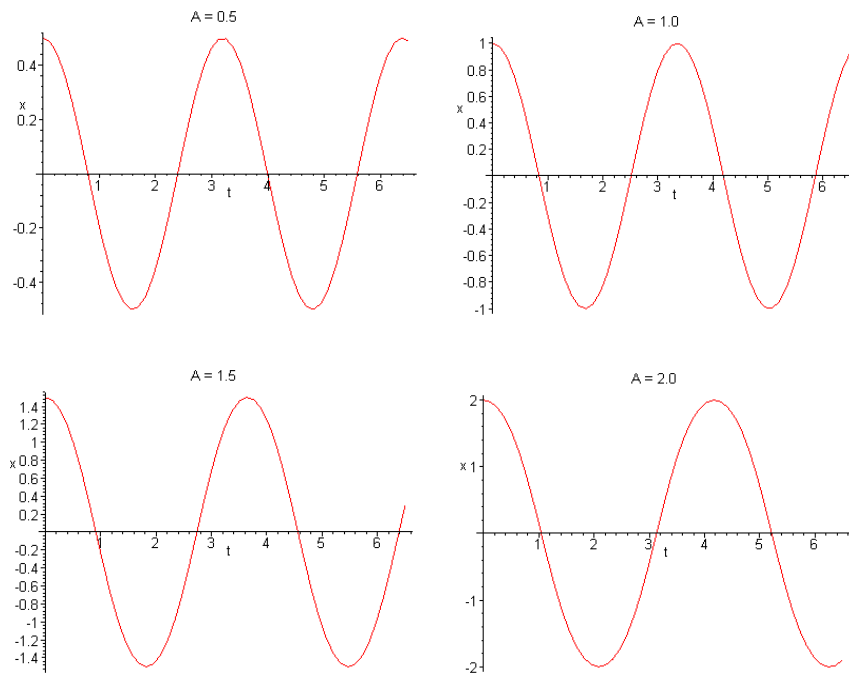

	$R$	$\tau$
$A = 0.5$	0.5	3.20
$A = 1.0$	1.0	3.35
$A = 1.5$	1.5	3.63
$A = 2.0$	2.0	4.17

(c). Since the system is conservative, the amplitude is equal to the initial amplitude. On

the other hand, the period of the pendulum is a *monotone increasing* function of the initial position  $A$ .

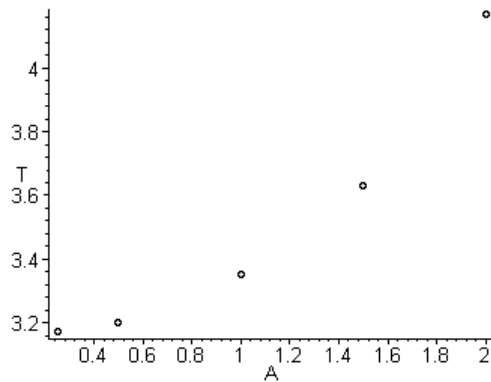

It appears that as  $A \rightarrow 0$ , the period approaches  $\pi$ , the period of the corresponding *linear* pendulum ( $2\pi/\omega$ ).

(d).

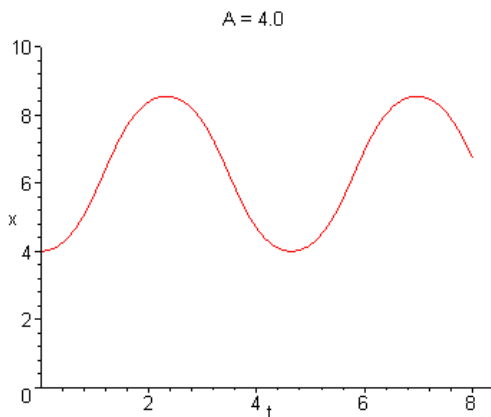

The pendulum is released from rest, at an inclination of  $4 - \pi$  radians from the vertical. Based on *conservation of energy*, the pendulum will swing past the lower equilibrium position ( $\theta = 2\pi$ ) and come to rest, momentarily, at a maximum rotational displacement of  $\theta_{max} = 3\pi - (4 - \pi) = 4\pi - 4$ . The transition between the two dynamics occurs at  $A = \pi$ , that is, once the pendulum is released *beyond* the upright configuration.

24(a). It is evident that the origin is a critical point of each system. Furthermore, it is easy to see that the corresponding linear system, in each case, is given by

$$\begin{aligned} \frac{dx}{dt} &= y \\ \frac{dy}{dt} &= -x. \end{aligned}$$

The eigenvalues of the coefficient matrix are  $r_{1,2} = \pm i$ . Hence the critical point of the

linearized system is a *center*.

(b). Using polar coordinates, it is also easy to show that

$$\lim_{r \rightarrow 0} \frac{\|\mathbf{g}(\mathbf{x})\|}{\|\mathbf{x}\|} = 0.$$

Alternatively, the nonlinear terms are *analytic* in the entire plane. Hence both systems are almost linear near the origin.

(c). For system (ii), note that

$$x \frac{dx}{dt} + y \frac{dy}{dt} = xy - x^2(x^2 + y^2) - xy - y^2(x^2 + y^2).$$

Converting to polar coordinates, and differentiating the equation  $r^2 = x^2 + y^2$  with respect to  $t$ , we find that

$$r \frac{dr}{dt} = x \frac{dx}{dt} + y \frac{dy}{dt} = - (x^2 + y^2)^2 = -r^4.$$

That is,  $r' = -r^3$ . It follows that  $r^2 = 1/(2t + c)$ , where  $c = 1/r_0^2$ . Since  $r \rightarrow 0$  as  $t \rightarrow \infty$ , regardless of the value of  $r_0$ , the origin is an *asymptotically stable* equilibrium point.

On the other hand, for system (i),

$$r \frac{dr}{dt} = x \frac{dx}{dt} + y \frac{dy}{dt} = (x^2 + y^2)^2 = r^4.$$

That is,  $r' = r^3$ . Solving the differential equation results in

$$r^2 = \frac{c - 2t}{(2t - c)^2}.$$

Imposing the initial condition  $r(0) = r_0$ , we obtain a specific solution

$$r^2 = -\frac{r_0^2}{2r_0^2 t - 1}.$$

Since the solution becomes *unbounded* as  $t \rightarrow 1/2r_0^2$ , the critical point is *unstable*.

25. The characteristic equation of the coefficient matrix is  $r^2 + 1 = 0$ , with complex roots  $r_{1,2} = \pm i$ . Hence the critical point at the origin is a *center*. The characteristic equation of the perturbed matrix is  $r^2 - 2\epsilon r + 1 + \epsilon^2 = 0$ , with complex conjugate roots  $r_{1,2} = \epsilon \pm i$ . As long as  $\epsilon \neq 0$ , the critical point of the perturbed system is a *spiral point*. Its stability depends on the sign of  $\epsilon$ .

26. The characteristic equation of the coefficient matrix is  $(r + 1)^2 = 0$ , with roots



$r_1 = r_2 = -1$ . Hence the critical point is an *asymptotically stable node*. On the other hand, the characteristic equation of the perturbed system is  $r^2 + 2r + 1 + \epsilon = 0$ , with roots  $r_{1,2} = -1 \pm \sqrt{-\epsilon}$ . If  $\epsilon > 0$ , then  $r_{1,2} = -1 \pm i\sqrt{\epsilon}$  are complex roots. The critical point is a *stable spiral*. If  $\epsilon < 0$ , then  $r_{1,2} = -1 \pm \sqrt{|\epsilon|}$  are real and both negative ( $|\epsilon| \ll 1$ ). The critical point remains a *stable node*.

27(d). Set  $k = \sin(\alpha/2) = \sin(A/2)$  and  $g/L = 4$ .

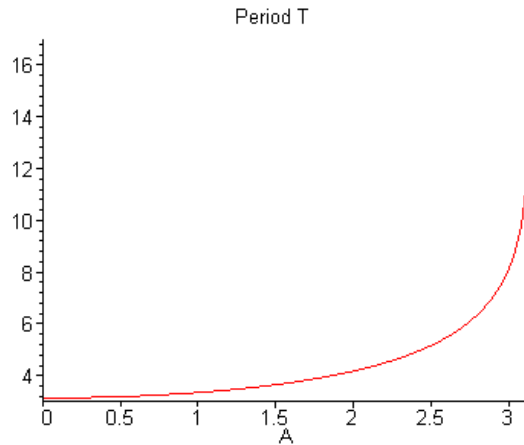

## Section 9.4

1(a).

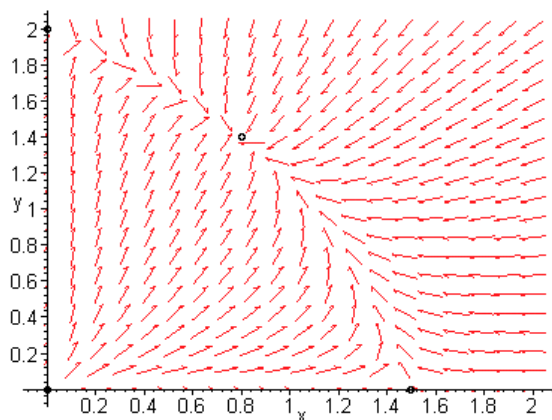

(b). The critical points are solutions of the system of equations

$$\begin{aligned}x(1.5 - x - 0.5y) &= 0 \\y(2 - y - 0.75x) &= 0.\end{aligned}$$

The four critical points are  $(0, 0)$ ,  $(0, 2)$ ,  $(1.5, 0)$  and  $(0.8, 1.4)$ .

(c). The Jacobian matrix of the vector field is

$$\mathbf{J} = \begin{pmatrix} 3/2 - 2x - y/2 & -x/2 \\ -3y/4 & 2 - 3x/4 - 2y \end{pmatrix}.$$

At the critical point  $(0, 0)$ , the coefficient matrix of the linearized system is

$$\mathbf{J}(0, 0) = \begin{pmatrix} 3/2 & 0 \\ 0 & 2 \end{pmatrix}.$$

The eigenvalues and eigenvectors are

$$r_1 = 3/2, \quad \boldsymbol{\xi}^{(1)} = \begin{pmatrix} 1 \\ 0 \end{pmatrix}; \quad r_2 = 2, \quad \boldsymbol{\xi}^{(2)} = \begin{pmatrix} 0 \\ 1 \end{pmatrix}.$$

The eigenvalues are positive, hence the origin is an *unstable node*.At the critical point  $(0, 2)$ , the coefficient matrix of the linearized system is

$$\mathbf{J}(0, 2) = \begin{pmatrix} 1/2 & 0 \\ -3/2 & -2 \end{pmatrix}.$$

The eigenvalues and eigenvectors are

$$r_1 = 1/2, \quad \boldsymbol{\xi}^{(1)} = \begin{pmatrix} 1 \\ -0.6 \end{pmatrix}; \quad r_2 = -2, \quad \boldsymbol{\xi}^{(2)} = \begin{pmatrix} 0 \\ 1 \end{pmatrix}.$$

The eigenvalues are of opposite sign. Hence the critical point is a *saddle*, which is *unstable*.

At the critical point  $(1.5, 0)$ , the coefficient matrix of the linearized system is

$$\mathbf{J}(1.5, 0) = \begin{pmatrix} -1.5 & -0.75 \\ 0 & 0.875 \end{pmatrix}.$$

The eigenvalues and eigenvectors are

$$r_1 = -1.5, \quad \boldsymbol{\xi}^{(1)} = \begin{pmatrix} 1 \\ 0 \end{pmatrix}; \quad r_2 = 0.875, \quad \boldsymbol{\xi}^{(2)} = \begin{pmatrix} -0.31579 \\ 1 \end{pmatrix}.$$

The eigenvalues are of opposite sign. Hence the critical point is also a *saddle*, which is *unstable*.

At the critical point  $(0.8, 1.4)$ , the coefficient matrix of the linearized system is

$$\mathbf{J}(0.8, 1.4) = \begin{pmatrix} -0.8 & -0.4 \\ -1.05 & -1.4 \end{pmatrix}.$$

The eigenvalues and eigenvectors are

$$r_1 = -\frac{11}{10} + \frac{\sqrt{51}}{10}, \quad \boldsymbol{\xi}^{(1)} = \begin{pmatrix} 1 \\ \frac{3-\sqrt{51}}{4} \end{pmatrix}; \quad r_2 = -\frac{11}{10} - \frac{\sqrt{51}}{10}, \quad \boldsymbol{\xi}^{(2)} = \begin{pmatrix} 1 \\ \frac{3+\sqrt{51}}{4} \end{pmatrix}.$$

The eigenvalues are both negative. Hence the critical point is a *stable node*, which is *asymptotically stable*.

(d, e).

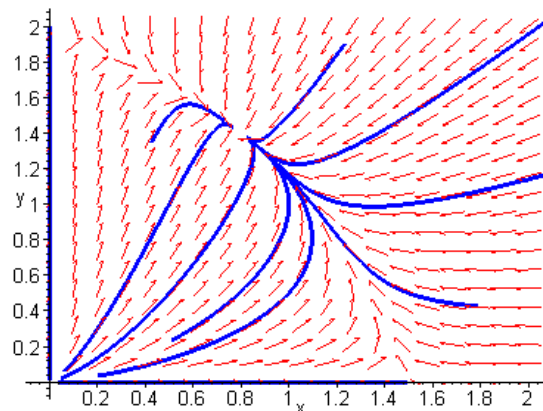

(f). Except for initial conditions lying on the coordinate axes, almost all trajectories

converge to the stable node at  $(0.8, 1.4)$ .

2(a).

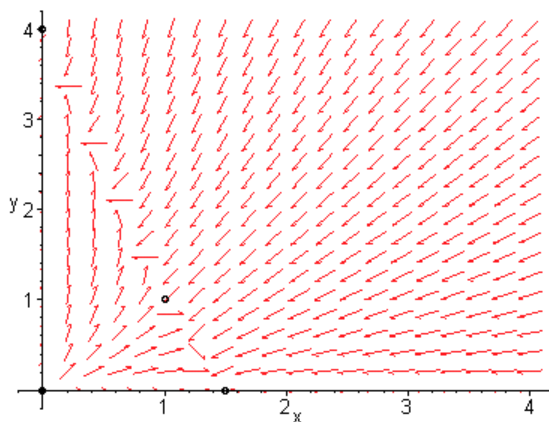

(b). The critical points are the solution set of the system of equations

$$\begin{aligned}x(1.5 - x - 0.5y) &= 0 \\y(2 - 0.5y - 1.5x) &= 0.\end{aligned}$$

The four critical points are  $(0, 0)$ ,  $(0, 4)$ ,  $(1.5, 0)$  and  $(1, 1)$ .

(c). The Jacobian matrix of the vector field is

$$\mathbf{J} = \begin{pmatrix} 3/2 - 2x - y/2 & -x/2 \\ -3y/2 & 2 - 3x/2 - y \end{pmatrix}.$$

At the origin, the coefficient matrix of the linearized system is

$$\mathbf{J}(0, 0) = \begin{pmatrix} 3/2 & 0 \\ 0 & 2 \end{pmatrix}.$$

The eigenvalues and eigenvectors are

$$r_1 = 3/2, \quad \boldsymbol{\xi}^{(1)} = \begin{pmatrix} 1 \\ 0 \end{pmatrix}; \quad r_2 = 2, \quad \boldsymbol{\xi}^{(2)} = \begin{pmatrix} 0 \\ 1 \end{pmatrix}.$$

The eigenvalues are positive, hence the origin is an *unstable node*.

At the critical point  $(0, 4)$ , the coefficient matrix of the linearized system is

$$\mathbf{J}(0, 4) = \begin{pmatrix} -1/2 & 0 \\ -6 & -2 \end{pmatrix}.$$

The eigenvalues and eigenvectors are

$$r_1 = -1/2, \boldsymbol{\xi}^{(1)} = \begin{pmatrix} 1 \\ -4 \end{pmatrix}; \quad r_2 = -2, \boldsymbol{\xi}^{(2)} = \begin{pmatrix} 0 \\ 1 \end{pmatrix}.$$

The eigenvalues are both negative, hence the critical point  $(0, 4)$  is a *stable node*, which is *asymptotically stable*.

At the critical point  $(3/2, 0)$ , the coefficient matrix of the linearized system is

$$\mathbf{J}(3/2, 0) = \begin{pmatrix} -3/2 & -3/4 \\ 0 & -1/4 \end{pmatrix}.$$

The eigenvalues and eigenvectors are

$$r_1 = -3/2, \boldsymbol{\xi}^{(1)} = \begin{pmatrix} 1 \\ 0 \end{pmatrix}; \quad r_2 = -1/4, \boldsymbol{\xi}^{(2)} = \begin{pmatrix} 3 \\ -5 \end{pmatrix}.$$

The eigenvalues are both negative, hence the critical point is a *stable node*, which is *asymptotically stable*.

At the critical point  $(1, 1)$ , the coefficient matrix of the linearized system is

$$\mathbf{J}(1, 1) = \begin{pmatrix} -1 & -1/2 \\ -3/2 & -1/2 \end{pmatrix}.$$

The eigenvalues and eigenvectors are

$$r_1 = \frac{-3 + \sqrt{13}}{4}, \boldsymbol{\xi}^{(1)} = \begin{pmatrix} 1 \\ -\frac{1 + \sqrt{13}}{2} \end{pmatrix}; \quad r_2 = -\frac{3 + \sqrt{13}}{4}, \boldsymbol{\xi}^{(2)} = \begin{pmatrix} 0 \\ \frac{-1 + \sqrt{13}}{2} \end{pmatrix}.$$

The eigenvalues are of opposite sign, hence  $(1, 1)$  is a *saddle*, which is *unstable*.

(d, e).

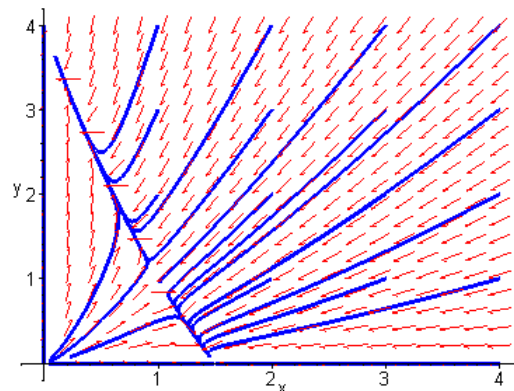

(f). Trajectories *approaching* the critical point  $(1, 1)$  form a *separatrix*. Solutions on either side of the separatrix approach either  $(0, 4)$  or  $(1.5, 0)$ .

4(a).

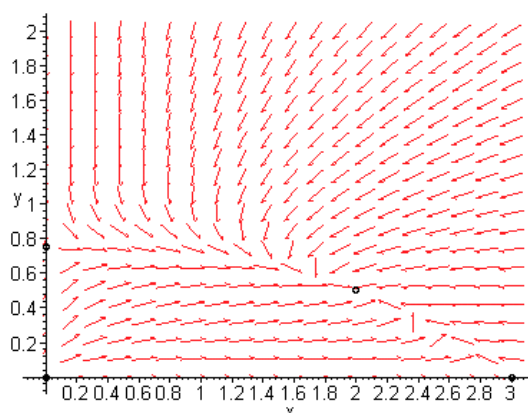

(b). The critical points are solutions of the system of equations

$$\begin{aligned}x(1.5 - 0.5x - y) &= 0 \\y(0.75 - y - 0.125x) &= 0.\end{aligned}$$

The four critical points are  $(0, 0)$ ,  $(0, 3/4)$ ,  $(3, 0)$  and  $(2, 1/2)$ .

(c). The Jacobian matrix of the vector field is

$$\mathbf{J} = \begin{pmatrix} 3/2 - x - y & -x \\ -y/8 & 3/4 - x/8 - 2y \end{pmatrix}.$$

At the origin, the coefficient matrix of the linearized system is

$$\mathbf{J}(0, 0) = \begin{pmatrix} 3/2 & 0 \\ 0 & 3/4 \end{pmatrix}.$$

The eigenvalues and eigenvectors are

$$r_1 = 3/2, \quad \boldsymbol{\xi}^{(1)} = \begin{pmatrix} 1 \\ 0 \end{pmatrix}; \quad r_2 = 3/4, \quad \boldsymbol{\xi}^{(2)} = \begin{pmatrix} 0 \\ 1 \end{pmatrix}.$$

The eigenvalues are positive, hence the origin is an *unstable node*.At the critical point  $(0, 3/4)$ , the coefficient matrix of the linearized system is

$$\mathbf{J}(0, 3/4) = \begin{pmatrix} 3/4 & 0 \\ -3/32 & -3/4 \end{pmatrix}.$$

The eigenvalues and eigenvectors are

$$r_1 = 3/4, \quad \boldsymbol{\xi}^{(1)} = \begin{pmatrix} -16 \\ 1 \end{pmatrix}; \quad r_2 = -3/4, \quad \boldsymbol{\xi}^{(2)} = \begin{pmatrix} 0 \\ 1 \end{pmatrix}.$$

The eigenvalues are of opposite sign, hence the critical point  $(0, 3/4)$  is a *saddle*, which is *unstable*.

At the critical point  $(3, 0)$ , the coefficient matrix of the linearized system is

$$\mathbf{J}(3, 0) = \begin{pmatrix} -3/2 & -3 \\ 0 & 3/8 \end{pmatrix}.$$

The eigenvalues and eigenvectors are

$$r_1 = -3/2, \quad \boldsymbol{\xi}^{(1)} = \begin{pmatrix} 1 \\ 0 \end{pmatrix}; \quad r_2 = 3/8, \quad \boldsymbol{\xi}^{(2)} = \begin{pmatrix} -8 \\ 5 \end{pmatrix}.$$

The eigenvalues are of opposite sign, hence the critical point  $(0, 3/4)$  is a *saddle*, which is *unstable*.

At the critical point  $(2, 1/2)$ , the coefficient matrix of the linearized system is

$$\mathbf{J}(2, 1/2) = \begin{pmatrix} -1 & -2 \\ -1/16 & -1/2 \end{pmatrix}.$$

The eigenvalues and eigenvectors are

$$r_1 = \frac{-3 + \sqrt{3}}{4}, \quad \boldsymbol{\xi}^{(1)} = \begin{pmatrix} 1 \\ -\frac{1 + \sqrt{3}}{8} \end{pmatrix}; \quad r_2 = -\frac{3 + \sqrt{3}}{4}, \quad \boldsymbol{\xi}^{(2)} = \begin{pmatrix} 0 \\ \frac{-1 + \sqrt{3}}{8} \end{pmatrix}.$$

The eigenvalues are negative, hence the critical point  $(2, 1/2)$  is a *stable node*, which is *asymptotically stable*.

(d, e).

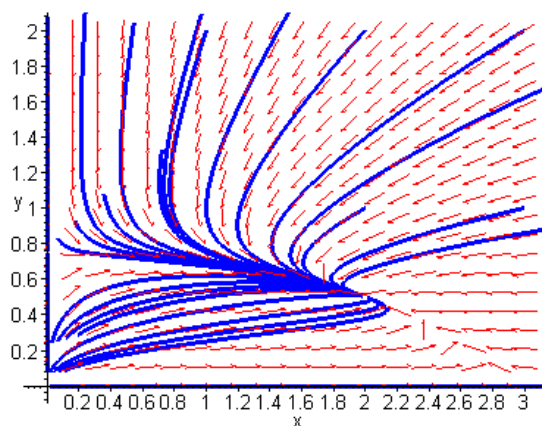

(f). Except for initial conditions along the coordinate axes, almost all solutions converge to the stable node  $(2, 1/2)$ .

7. It follows immediately that

$$\begin{aligned}(\sigma_1 X + \sigma_2 Y)^2 - 4\sigma_1\sigma_2 XY &= \sigma_1^2 X^2 + 2\sigma_1\sigma_2 XY + \sigma_2^2 Y^2 - 4\sigma_1\sigma_2 XY \\ &= (\sigma_1 X - \sigma_2 Y)^2.\end{aligned}$$

Since all parameters and variables are *positive*, it follows that

$$(\sigma_1 X + \sigma_2 Y)^2 - 4(\sigma_1\sigma_2 - \alpha_1\alpha_2)XY \geq 0.$$

Hence the radicand in Eq.(39) is *nonnegative*.

10(a). The critical points consist of the solution set of the equations

$$\begin{aligned}x(\epsilon_1 - \sigma_1 x - \alpha_1 y) &= 0 \\ y(\epsilon_2 - \sigma_2 y - \alpha_2 x) &= 0.\end{aligned}$$

If  $x = 0$ , then either  $y = 0$  or  $y = \epsilon_2/\sigma_2$ . If  $\epsilon_1 - \sigma_1 x - \alpha_1 y = 0$ , then solving for  $x$  results in  $x = (\epsilon_1 - \alpha_1 y)/\sigma_1$ . Substitution into the *second* equation yields

$$(\sigma_1\sigma_2 - \alpha_1\alpha_2)y^2 - (\sigma_1\epsilon_2 - \epsilon_1\alpha_2)y = 0.$$

Based on the hypothesis, it follows that  $(\sigma_1\epsilon_2 - \epsilon_1\alpha_2)y = 0$ . So if  $\sigma_1\epsilon_2 - \epsilon_1\alpha_2 \neq 0$ , then  $y = 0$ , and the critical points are located at  $(0, 0)$ ,  $(0, \epsilon_2/\sigma_2)$  and  $(\epsilon_1/\sigma_1, 0)$ .

For the case  $\sigma_1\epsilon_2 - \epsilon_1\alpha_2 = 0$ ,  $y$  can be arbitrary. From the relation  $x = (\epsilon_1 - \alpha_1 y)/\sigma_1$ , we conclude that all points on the line  $\sigma_1 x + \alpha_1 y = \epsilon_1$  are critical points, in addition to the point  $(0, 0)$ .

(b). The Jacobian matrix of the vector field is

$$\mathbf{J} = \begin{pmatrix} \epsilon_1 - 2\sigma_1 x - \alpha_1 y & -\alpha_1 x \\ -\alpha_2 y & \epsilon_2 - 2\sigma_2 y - \alpha_2 x \end{pmatrix}.$$

At the origin, the coefficient matrix of the linearized system is

$$\mathbf{J}(0, 0) = \begin{pmatrix} \epsilon_1 & 0 \\ 0 & \epsilon_2 \end{pmatrix},$$

with eigenvalues  $r_1 = \epsilon_1$  and  $r_2 = \epsilon_2$ . Since both eigenvalues are *positive*, the origin is an *unstable node*.

At the point  $(0, \epsilon_2/\sigma_2)$ , the coefficient matrix of the linearized system is

$$\mathbf{J}(0, \epsilon_2/\sigma_2) = \begin{pmatrix} (\epsilon_1\alpha_2 - \sigma_1\epsilon_2)/\alpha_2 & 0 \\ \epsilon_2\alpha_2/\sigma_2 & -\epsilon_2 \end{pmatrix},$$

with eigenvalues  $r_1 = (\epsilon_1\alpha_2 - \sigma_1\epsilon_2)/\alpha_2$  and  $r_2 = -\epsilon_2$ . If  $\sigma_1\epsilon_2 - \epsilon_1\alpha_2 > 0$ , then both eigenvalues are *negative*. Hence the point  $(0, \epsilon_2/\sigma_2)$  is a *stable node*, which is *asymptotically stable*. If  $\sigma_1\epsilon_2 - \epsilon_1\alpha_2 < 0$ , then the eigenvalues are of opposite sign. Hence the point  $(0, \epsilon_2/\sigma_2)$  is a *saddle*, which is *unstable*.



At the point  $(\epsilon_1/\sigma_1, 0)$ , the coefficient matrix of the linearized system is

$$\mathbf{J}(\epsilon_1/\sigma_1, 0) = \begin{pmatrix} -\epsilon_1 & -\epsilon_1\alpha_1/\sigma_1 \\ 0 & (\sigma_1\epsilon_2 - \epsilon_1\alpha_2)/\sigma_1 \end{pmatrix},$$

with eigenvalues  $r_1 = (\sigma_1\epsilon_2 - \epsilon_1\alpha_2)/\sigma_1$  and  $r_2 = -\epsilon_1$ . If  $\sigma_1\epsilon_2 - \epsilon_1\alpha_2 > 0$ , then the eigenvalues are of *opposite* sign. Hence the point  $(\epsilon_1/\sigma_1, 0)$  is a *saddle*, which is *unstable*. If  $\sigma_1\epsilon_2 - \epsilon_1\alpha_2 < 0$ , then both eigenvalues are *negative*. In that case the point  $(\epsilon_1/\sigma_1, 0)$  is a *stable node*, which is *asymptotically stable*.

(c). As shown in Part (a), when  $\sigma_1\epsilon_2 - \epsilon_1\alpha_2 = 0$ , the set of critical points consists of  $(0, 0)$  and all of the points on the straight line  $\sigma_1x + \alpha_1y = \epsilon_1$ . Based on Part (b), the origin is still an *unstable node*. Setting  $y = (\epsilon_1 - \sigma_1x)/\alpha_1$ , the Jacobian matrix of the vector field, *along the given straight line*, is

$$\mathbf{J} = \begin{pmatrix} -\sigma_1x & -\alpha_1x \\ -\alpha_2(\epsilon_1 - \sigma_1x)/\alpha_1 & \alpha_2x - \epsilon_1\alpha_2/\sigma_1 \end{pmatrix}.$$

The characteristic equation of the matrix is

$$r^2 + \left[ \frac{\epsilon_1\alpha_2 - \alpha_2\sigma_1x + \sigma_1^2x}{\sigma_1} \right] r = 0.$$

Using the given hypothesis,  $(\epsilon_1\alpha_2 - \alpha_2\sigma_1x + \sigma_1^2x)/\sigma_1 = \epsilon_2 - \alpha_2x + \sigma_1x$ . Hence the characteristic equation can be written as

$$r^2 + [\epsilon_2 - \alpha_2x + \sigma_1x]r = 0.$$

First note that  $0 \leq x \leq \epsilon_1/\sigma_1$ . Since the coefficient in the quadratic equation is *linear*, and

$$\epsilon_2 - \alpha_2x + \sigma_1x = \begin{cases} \epsilon_2 & \text{at } x = 0 \\ \epsilon_1 & \text{at } x = \epsilon_1/\sigma_1, \end{cases}$$

it follows that the coefficient is *positive* for  $0 \leq x \leq \epsilon_1/\sigma_1$ . Therefore, along the straight line  $\sigma_1x + \alpha_1y = \epsilon_1$ , one eigenvalue is *zero* and the other one is *negative*. Hence the continuum of critical points consists of *stable nodes*, which are *asymptotically stable*.

11(a). The critical points are solutions of the system of equations

$$\begin{aligned} x(1 - x - y) + \delta a &= 0 \\ y(0.75 - y - 0.5x) + \delta b &= 0. \end{aligned}$$

Assume solutions of the form

$$\begin{aligned} x &= x_0 + x_1\delta + x_2\delta^2 + \cdots \\ y &= y_0 + y_1\delta + y_2\delta^2 + \cdots. \end{aligned}$$

Substitution of the series expansions results in

$$\begin{aligned} x_0(1 - x_0 - y_0) + (x_1 - 2x_1x_0 - x_0y_1 - x_1y_0 + a)\delta + \dots &= 0 \\ y_0(0.75 - y_0 - 0.5x_0) + (0.75y_1 - 2y_0y_1 - x_1y_0/2 - x_0y_1/2 + b)\delta + \dots &= 0. \end{aligned}$$

(b). Taking a limit as  $\delta \rightarrow 0$ , the equations reduce to the original system of equations. It follows that  $x_0 = y_0 = 0.5$ .

(c). Setting the coefficients of the *linear* terms equal to zero, we find that

$$\begin{aligned} -y_1/2 - x_1/2 + a &= 0 \\ -x_1/4 - y_1/2 + b &= 0, \end{aligned}$$

with solution  $x_1 = 4a - 4b$  and  $y_1 = -2a + 4b$ .

(d). Consider the  $ab$ -parameter space. The collection of points for which  $b < a$  represents an *increase* in the level of species 1. At points where  $b > a$ ,  $x_1\delta < 0$ . Likewise, the collection of points for which  $2b > a$  represents an *increase* in the level of species 2. At points where  $2b < a$ ,  $y_1\delta < 0$ .

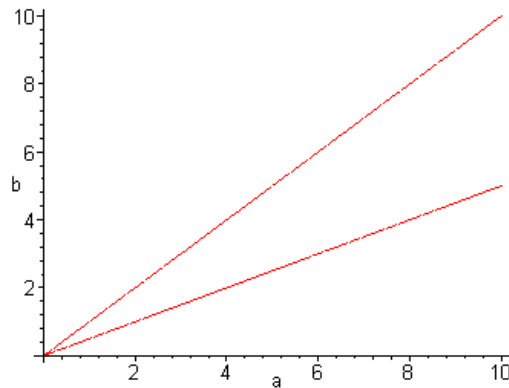

It follows that if  $b < a < 2b$ , the level of *both* species will *increase*. This condition is represented by the wedge-shaped region on the graph. Otherwise, the level of one species

will increase, whereas the level of the other species will simultaneously decrease. Only for  $a = b = 0$  will both populations remain the same.

13(a). The critical points consist of the solution set of the equations

$$\begin{aligned} -y &= 0 \\ -\gamma y - x(x - 0.15)(x - 2) &= 0. \end{aligned}$$

Setting  $y = 0$ , the second equation becomes  $x(x - 0.15)(x - 2) = 0$ , with roots  $x = 0$ , 0.15 and 2. Hence the critical points are located at  $(0, 0)$ ,  $(0.15, 0)$  and  $(2, 0)$ . The Jacobian matrix of the vector field is

$$\mathbf{J} = \begin{pmatrix} 0 & -1 \\ -3x^2 + 4.3x - 0.3 & -\gamma \end{pmatrix}.$$

At the origin, the coefficient matrix of the linearized system is

$$\mathbf{J}(0, 0) = \begin{pmatrix} 0 & -1 \\ -0.3 & -\gamma \end{pmatrix},$$

with eigenvalues

$$r_{1,2} = -\frac{\gamma}{2} \pm \frac{1}{10} \sqrt{25\gamma^2 + 30}.$$

Regardless of the value of  $\gamma$ , the eigenvalues are real and of opposite sign. Hence  $(0, 0)$  is a *saddle*, which is *unstable*.

At the critical point  $(0.15, 0)$ , the coefficient matrix of the linearized system is

$$\mathbf{J}(0.15, 0) = \begin{pmatrix} 0 & -1 \\ 0.2775 & -\gamma \end{pmatrix},$$

with eigenvalues

$$r_{1,2} = -\frac{\gamma}{2} \pm \frac{1}{20} \sqrt{100\gamma^2 - 111}.$$

If  $100\gamma^2 - 111 \geq 0$ , then the eigenvalues are real. Furthermore, since  $r_1 r_2 = 0.2775$ , both eigenvalues will have the same sign. Therefore the critical point is a *node*, with its stability dependent on the *sign* of  $\gamma$ . If  $100\gamma^2 - 111 < 0$ , the eigenvalues are complex conjugates. In that case the critical point  $(0.15, 0)$  is a *spiral*, with its stability dependent on the *sign* of  $\gamma$ .

At the critical point  $(2, 0)$ , the coefficient matrix of the linearized system is

$$\mathbf{J}(2, 0) = \begin{pmatrix} 0 & -1 \\ -3.7 & -\gamma \end{pmatrix},$$

with eigenvalues

$$r_{1,2} = -\frac{\gamma}{2} \pm \frac{1}{10} \sqrt{25\gamma^2 + 370}.$$

Regardless of the value of  $\gamma$ , the eigenvalues are real and of opposite sign. Hence  $(2, 0)$  is a *saddle*, which is *unstable*.

(b).

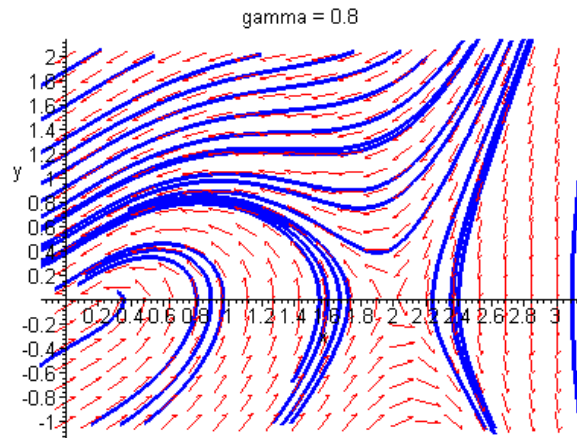

It is evident that for  $\gamma = 0.8$ , the critical point  $(0.15, 0)$  is a *stable spiral*.

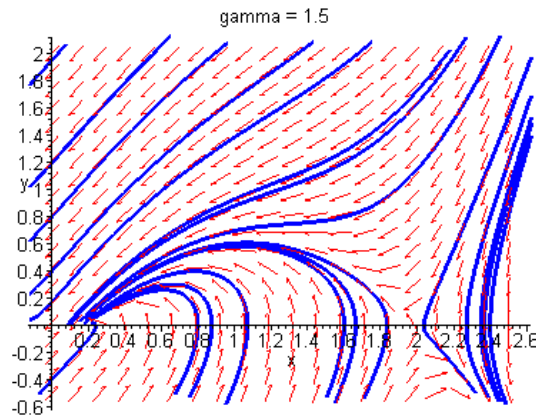

Closer examination shows that for  $\gamma = 1.5$ , the critical point  $(0.15, 0)$  is a *stable node*.

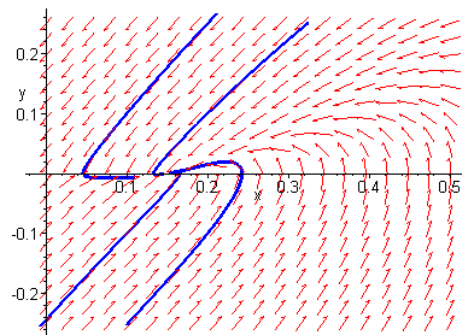

(c). Based on the phase portraits in Part (b), it is apparent that the required value of  $\gamma$  satisfies  $0.8 < \gamma < 1.5$ . Using the initial condition  $x(0) = 2$  and  $y(0) = 0.01$ , it is possible to solve the initial value problem for various values of  $\gamma$ . A reasonable first guess is  $\gamma = \sqrt{1.11}$ . This value marks the change in qualitative behavior of the critical

point  $(0.15, 0)$ . Numerical experiments show that the solution remains positive for  $\gamma \approx 1.20$ .

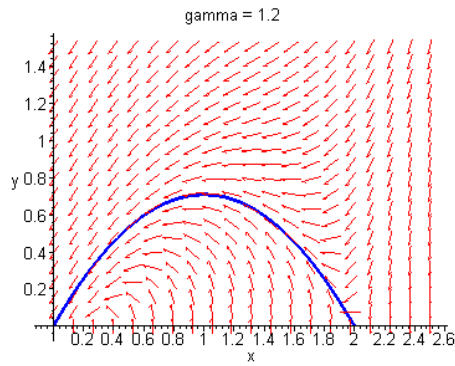
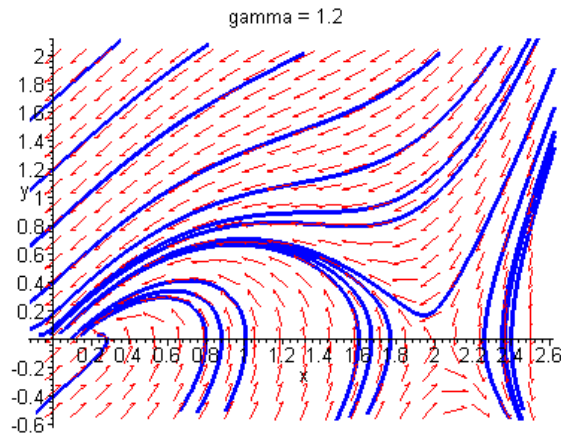

## Section 9.5

1(a).

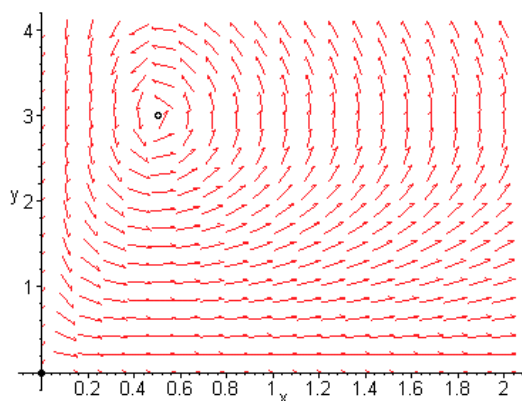

(b). The critical points are solutions of the system of equations

$$\begin{aligned}x(1.5 - 0.5y) &= 0 \\y(-0.5 + x) &= 0.\end{aligned}$$

The two critical points are  $(0, 0)$  and  $(0.5, 3)$ .

(c). The Jacobian matrix of the vector field is

$$\mathbf{J} = \begin{pmatrix} 3/2 - y/2 & -x/2 \\ y & -1/2 + x \end{pmatrix}.$$

At the critical point  $(0, 0)$ , the coefficient matrix of the linearized system is

$$\mathbf{J}(0, 0) = \begin{pmatrix} 3/2 & 0 \\ 0 & -1/2 \end{pmatrix}.$$

The eigenvalues and eigenvectors are

$$r_1 = 3/2, \quad \boldsymbol{\xi}^{(1)} = \begin{pmatrix} 1 \\ 0 \end{pmatrix}; \quad r_2 = -1/2, \quad \boldsymbol{\xi}^{(2)} = \begin{pmatrix} 0 \\ 1 \end{pmatrix}.$$

The eigenvalues are of opposite sign, hence the origin is a *saddle*, which is *unstable*.At the critical point  $(0.5, 3)$ , the coefficient matrix of the linearized system is

$$\mathbf{J}(0.5, 3) = \begin{pmatrix} 0 & -1/4 \\ 3 & 0 \end{pmatrix}.$$

The eigenvalues and eigenvectors are

$$r_1 = i \frac{\sqrt{3}}{2}, \quad \boldsymbol{\xi}^{(1)} = \begin{pmatrix} 1 \\ -2i\sqrt{3} \end{pmatrix}; \quad r_2 = -i \frac{\sqrt{3}}{2}, \quad \boldsymbol{\xi}^{(2)} = \begin{pmatrix} 1 \\ 2i\sqrt{3} \end{pmatrix}.$$

The eigenvalues are purely imaginary. Hence the critical point is a *center*, which is *stable*.

(d, e).

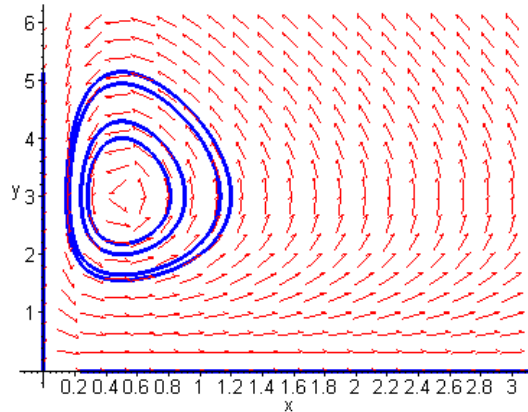

(f). Except for solutions along the coordinate axes, almost all trajectories are closed curves about the critical point (0.5, 3).

2(a).

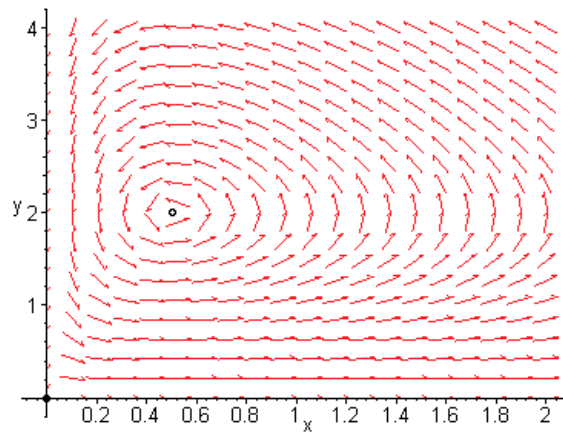

(b). The critical points are the solution set of the system of equations

$$\begin{aligned} x(1 - 0.5y) &= 0 \\ y(-0.25 + 0.5x) &= 0. \end{aligned}$$

The two critical points are (0, 0) and (0.5, 2).

(c). The Jacobian matrix of the vector field is

$$\mathbf{J} = \begin{pmatrix} 1 - y/2 & -x/2 \\ y/2 & -1/4 + x/2 \end{pmatrix}.$$

At the critical point (0, 0), the coefficient matrix of the linearized system is

$$\mathbf{J}(0,0) = \begin{pmatrix} 1 & 0 \\ 0 & -1/4 \end{pmatrix}.$$

The eigenvalues and eigenvectors are

$$r_1 = 1, \quad \boldsymbol{\xi}^{(1)} = \begin{pmatrix} 1 \\ 0 \end{pmatrix}; \quad r_2 = -1/4, \quad \boldsymbol{\xi}^{(2)} = \begin{pmatrix} 0 \\ 1 \end{pmatrix}.$$

The eigenvalues are of opposite sign, hence the origin is a *saddle*, which is *unstable*.

At the critical point  $(0.5, 2)$ , the coefficient matrix of the linearized system is

$$\mathbf{J}(0.5, 2) = \begin{pmatrix} 0 & -1/4 \\ 1 & 0 \end{pmatrix}.$$

The eigenvalues and eigenvectors are

$$r_1 = i/2, \quad \boldsymbol{\xi}^{(1)} = \begin{pmatrix} 1 \\ -2i \end{pmatrix}; \quad r_2 = -i/2, \quad \boldsymbol{\xi}^{(2)} = \begin{pmatrix} 1 \\ 2i \end{pmatrix}.$$

The eigenvalues are purely imaginary. Hence the critical point is a *center*, which is *stable*.

(d, e).

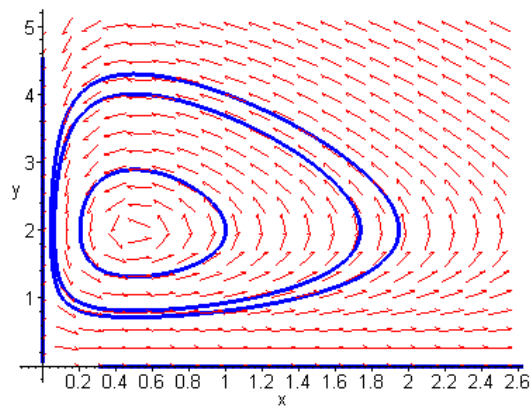

(f). Except for solutions along the coordinate axes, almost all trajectories are closed curves about the critical point  $(0.5, 2)$ .



4(a).

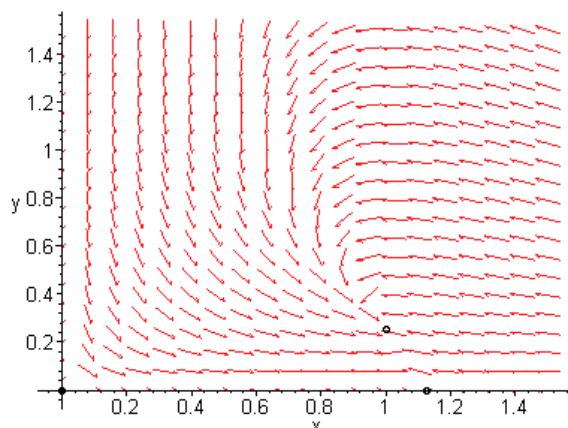

(b). The critical points are the solution set of the system of equations

$$\begin{aligned}x(9/8 - x - y/2) &= 0 \\ y(-1 + x) &= 0.\end{aligned}$$

The three critical points are  $(0, 0)$ ,  $(9/8, 0)$  and  $(1, 1/4)$ .

(c). The Jacobian matrix of the vector field is

$$\mathbf{J} = \begin{pmatrix} 9/8 - 2x - y/2 & -x/2 \\ y & -1 + x \end{pmatrix}.$$

At the critical point  $(0, 0)$ , the coefficient matrix of the linearized system is

$$\mathbf{J}(0, 0) = \begin{pmatrix} 9/8 & 0 \\ 0 & -1 \end{pmatrix}.$$

The eigenvalues and eigenvectors are

$$r_1 = 9/8, \quad \boldsymbol{\xi}^{(1)} = \begin{pmatrix} 1 \\ 0 \end{pmatrix}; \quad r_2 = -1, \quad \boldsymbol{\xi}^{(2)} = \begin{pmatrix} 0 \\ 1 \end{pmatrix}.$$

The eigenvalues are of opposite sign, hence the origin is a *saddle*, which is *unstable*.At the critical point  $(9/8, 0)$ , the coefficient matrix of the linearized system is

$$\mathbf{J}(9/8, 0) = \begin{pmatrix} -9/8 & -9/16 \\ 0 & 1/8 \end{pmatrix}.$$

The eigenvalues and eigenvectors are

$$r_1 = -\frac{9}{8}, \quad \boldsymbol{\xi}^{(1)} = \begin{pmatrix} 1 \\ 0 \end{pmatrix}; \quad r_2 = \frac{1}{8}, \quad \boldsymbol{\xi}^{(2)} = \begin{pmatrix} 9 \\ -20 \end{pmatrix}.$$

The eigenvalues are of opposite sign, hence the critical point  $(9/8, 0)$  is a *saddle*, which is *unstable*.

At the critical point  $(1, 1/4)$ , the coefficient matrix of the linearized system is

$$\mathbf{J}(1, 1/4) = \begin{pmatrix} -1 & -1/2 \\ 1/4 & 0 \end{pmatrix}.$$

The eigenvalues and eigenvectors are

$$r_1 = \frac{-2 + \sqrt{2}}{4}, \quad \boldsymbol{\xi}^{(1)} = \begin{pmatrix} -2 + \sqrt{2} \\ 1 \end{pmatrix}; \quad r_2 = \frac{-2 - \sqrt{2}}{4}, \quad \boldsymbol{\xi}^{(2)} = \begin{pmatrix} -2 - \sqrt{2} \\ 1 \end{pmatrix}.$$

The eigenvalues are both negative. Hence the critical point is a *stable node*, which is *asymptotically stable*.

(d, e).

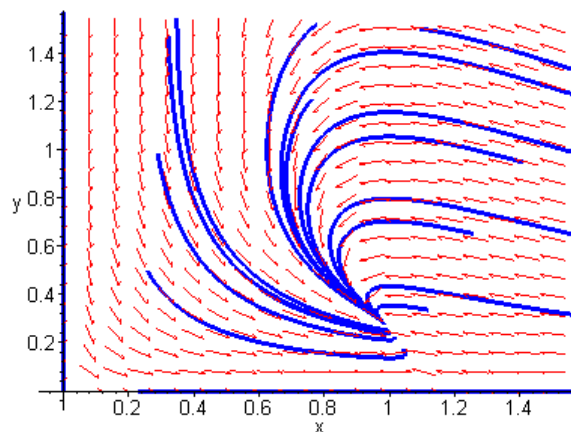

(f). Except for solutions along the coordinate axes, all solutions converge to the critical point  $(1, 1/4)$ .

5(a).

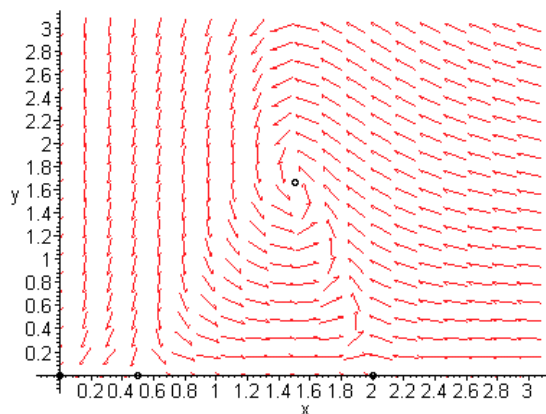

(b). The critical points are solutions of the system of equations

$$\begin{aligned}x(-1 + 2.5x - 0.3y - x^2) &= 0 \\ y(-1.5 + x) &= 0.\end{aligned}$$

The four critical points are  $(0, 0)$ ,  $(1/2, 0)$ ,  $(2, 0)$  and  $(3/2, 5/3)$ .

(c). The Jacobian matrix of the vector field is

$$\mathbf{J} = \begin{pmatrix} -1 + 5x - 3x^2 - 3y/10 & -3x/10 \\ y & -3/2 + x \end{pmatrix}.$$

At the critical point  $(0, 0)$ , the coefficient matrix of the linearized system is

$$\mathbf{J}(0, 0) = \begin{pmatrix} -1 & 0 \\ 0 & -3/2 \end{pmatrix}.$$

The eigenvalues and eigenvectors are

$$r_1 = -1, \boldsymbol{\xi}^{(1)} = \begin{pmatrix} 1 \\ 0 \end{pmatrix}; \quad r_2 = -3/2, \boldsymbol{\xi}^{(2)} = \begin{pmatrix} 0 \\ 1 \end{pmatrix}.$$

The eigenvalues are both negative, hence the critical point  $(0, 0)$  is a *stable node*, which is *asymptotically stable*.

At the critical point  $(1/2, 0)$ , the coefficient matrix of the linearized system is

$$\mathbf{J}(1/2, 0) = \begin{pmatrix} 3/4 & -3/20 \\ 0 & -1 \end{pmatrix}.$$

The eigenvalues and eigenvectors are

$$r_1 = \frac{3}{4}, \boldsymbol{\xi}^{(1)} = \begin{pmatrix} 1 \\ 0 \end{pmatrix}; \quad r_2 = -1, \boldsymbol{\xi}^{(2)} = \begin{pmatrix} 3 \\ 35 \end{pmatrix}.$$

The eigenvalues are of opposite sign, hence the critical point  $(1/2, 0)$  is a *saddle*, which is *unstable*.

At the critical point  $(2, 0)$ , the coefficient matrix of the linearized system is

$$\mathbf{J}(2, 0) = \begin{pmatrix} -3 & -3/5 \\ 0 & 1/2 \end{pmatrix}.$$

The eigenvalues and eigenvectors are

$$r_1 = -3, \boldsymbol{\xi}^{(1)} = \begin{pmatrix} 1 \\ 0 \end{pmatrix}; \quad r_2 = 1/2, \boldsymbol{\xi}^{(2)} = \begin{pmatrix} 6 \\ -35 \end{pmatrix}.$$

The eigenvalues are of opposite sign, hence the critical point  $(2, 0)$  is a *saddle*, which is *unstable*.

At the critical point  $(3/2, 5/3)$ , the coefficient matrix of the linearized system is

$$\mathbf{J}(3/2, 5/3) = \begin{pmatrix} -3/4 & -9/20 \\ 5/3 & 0 \end{pmatrix}.$$

The eigenvalues and eigenvectors are

$$r_1 = \frac{-3 + i\sqrt{39}}{8}, \quad \boldsymbol{\xi}^{(1)} = \begin{pmatrix} \frac{-9+i3\sqrt{39}}{40} \\ 1 \end{pmatrix}; \quad r_2 = \frac{-3 - i\sqrt{39}}{8}, \quad \boldsymbol{\xi}^{(2)} = \begin{pmatrix} \frac{-9-i3\sqrt{39}}{40} \\ 1 \end{pmatrix}.$$

The eigenvalues are complex conjugates. Hence the critical point  $(3/2, 5/3)$  is a *stable spiral*, which is *asymptotically stable*.

(d, e).

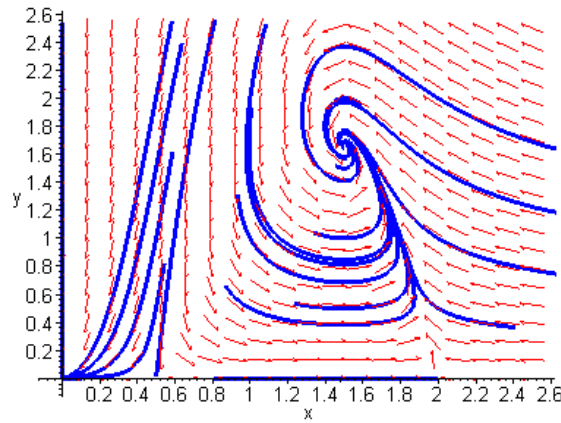

(f). The single solution curve that converges to the node at  $(1/2, 0)$  is a *separatrix*. Except for initial conditions on the coordinate axes, trajectories on either side of the separatrix converge to the node at  $(0, 0)$  or the stable spiral at  $(3/2, 5/3)$ .

6. Given that  $t$  is measured from the time that  $x$  is a *maximum*, we have

$$x = \frac{c}{\gamma} + \frac{cK}{\gamma} \cos(\sqrt{ac} t)$$

$$y = \frac{a}{\alpha} + K \frac{a}{\alpha} \sqrt{\frac{c}{\alpha}} \sin(\sqrt{ac} t).$$

The *period* of oscillation is evidently  $T = 2\pi/\sqrt{ac}$ . Both populations oscillate about a mean value. The following is based on the properties of the *cos* and *sin* functions

The prey population ( $x$ ) is *maximum* at  $t = 0$  and  $t = T$ . It is a *minimum* at  $t = T/2$ . Its rate of increase is greatest at  $t = 3T/4$ . The rate of *decrease* of the prey population is greatest at  $t = T/4$ .

The predator population ( $y$ ) is *maximum* at  $t = T/4$ . It is a *minimum* at  $t = 3T/4$ .

The rate of increase of the predator population is greatest at  $t = 0$  and  $t = T$ . The rate of decrease of the predator population is greatest at  $t = T/2$ .

In the following example, the system in Problem 2 is solved numerically with the initial conditions  $x(0) = 0.7$  and  $y(0) = 2$ . The critical point of interest is at  $(0.5, 2)$ . Since  $a = 1$  and  $c = 1/4$ , it follows that the period of oscillation is  $T = 4\pi$ .

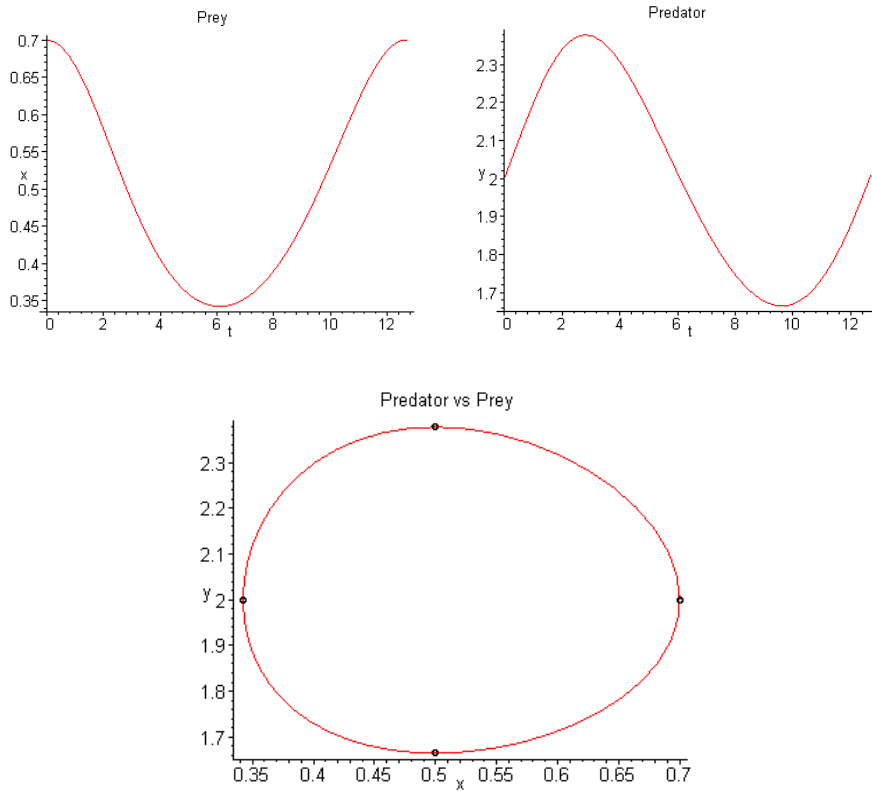

8(a). The *period* of oscillation for the linear system is  $T = 2\pi/\sqrt{ac}$ . In system (2),  $a = 1$  and  $c = 0.75$ . Hence the period is estimated as  $T = 2\pi/\sqrt{0.75} \approx 7.2552$ .

(b). The estimated period appears to agree with the graphic in Figure 9.5.3.

(c). The critical point of interest is at  $(3, 2)$ . The system is solved numerically, with  $y(0) = 2$  and  $x(0) = 3.5, 4.0, 4.5, 5.0$ . The resulting periods are shown in the table:

	$x(0) = 3.5$	$x(0) = 4.0$	$x(0) = 4.5$	$x(0) = 5.0$
$T$	7.26	7.29	7.34	7.42

The actual amplitude steadily *increases* as the amplitude increases.

9. The system

$$\begin{aligned} \frac{dx}{dt} &= ax \left(1 - \frac{y}{2}\right) \\ \frac{dy}{dt} &= by \left(-1 + \frac{x}{3}\right) \end{aligned}$$

is solved numerically for various values of the parameters. The initial conditions are  $x(0) = 5$ ,  $y(0) = 2$ .

(a).  $a = 1$  and  $b = 1$  :

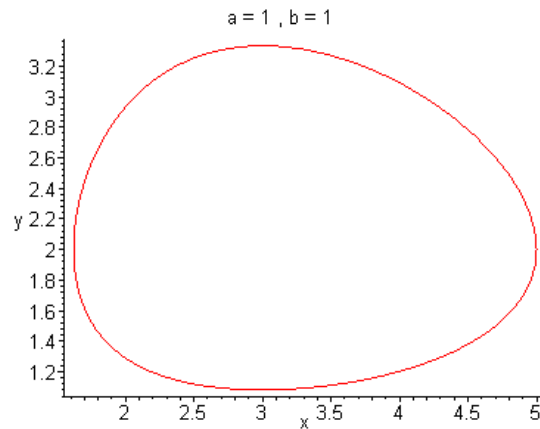

The period is estimated by observing when the trajectory becomes a closed curve. In this case,  $T \approx 6.45$ .

(b).  $a = 3$  and  $a = 1/3$ , with  $b = 1$  :

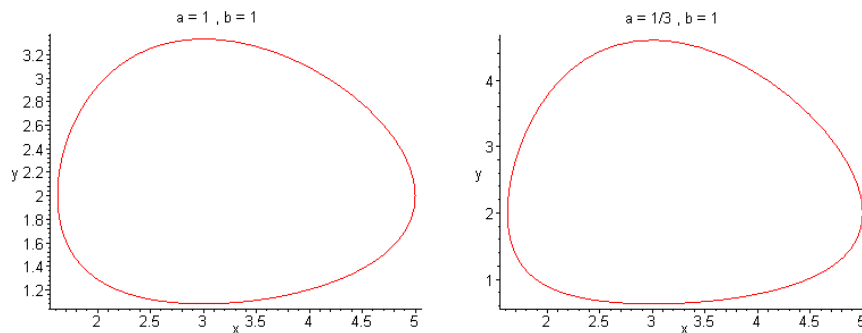

For  $a = 3$ ,  $T \approx 3.69$ . For  $a = 1/3$ ,  $T \approx 11.44$ .

(c).  $b = 3$  and  $b = 1/3$ , with  $a = 1$  :

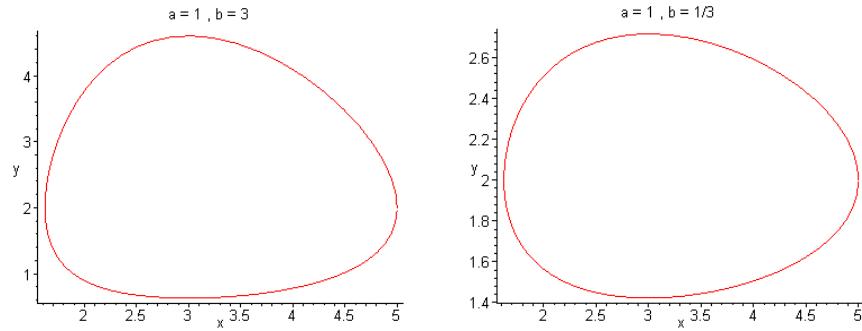

For  $b = 3$ ,  $T \approx 3.82$ . For  $b = 1/3$ ,  $T \approx 11.06$ .

(d). It appears that if one of the parameters is fixed, the period varies *inversely* with the other parameter. Hence one might postulate the relation

$$T = \frac{k}{f(a, b)}.$$

10(a). Since  $T = 2\pi/\sqrt{ac}$ , we first note that

$$\int_A^{A+T} \cos(\sqrt{ac} t + \phi) dt = \int_A^{A+T} \sin(\sqrt{ac} t + \phi) dt = 0.$$

Hence

$$\bar{x} = \frac{1}{T} \int_A^{A+T} \frac{c}{\gamma} dt = \frac{c}{\gamma} \text{ and } \bar{y} = \frac{1}{T} \int_A^{A+T} \frac{a}{\alpha} dt = \frac{a}{\alpha}.$$

(b). One way to estimate the mean values is to find a horizontal line such that the area above the line is approximately equal to the area under the line. From Figure 9.5.3, it appears that  $\bar{x} \approx 3.25$  and  $\bar{y} \approx 2.0$ . In Example 1,  $a = 1$ ,  $c = 0.75$ ,  $\alpha = 0.5$  and  $\gamma = 0.25$ . Using the result in Part (a),  $\bar{x} = 3$  and  $\bar{y} = 2$ .

(c). The system

$$\begin{aligned} \frac{dx}{dt} &= x \left( 1 - \frac{y}{2} \right) \\ \frac{dy}{dt} &= y \left( -\frac{3}{4} + \frac{x}{4} \right) \end{aligned}$$

is solved numerically for various initial conditions.

$x(0) = 3$  and  $y(0) = 2.5$  :

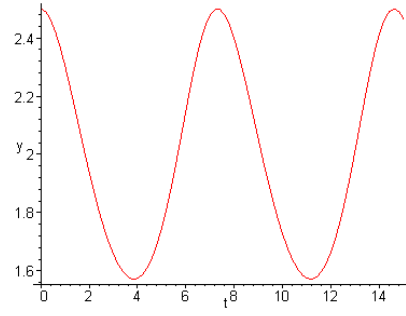
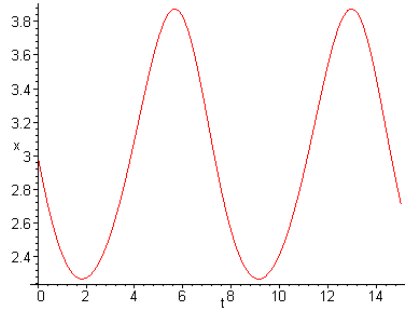

$x(0) = 3$  and  $y(0) = 3.0$  :

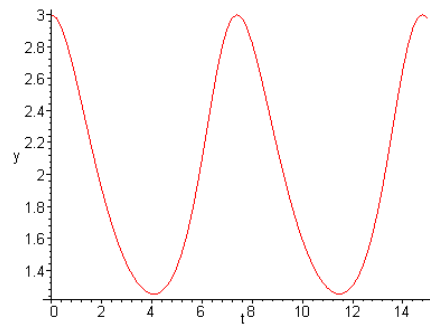
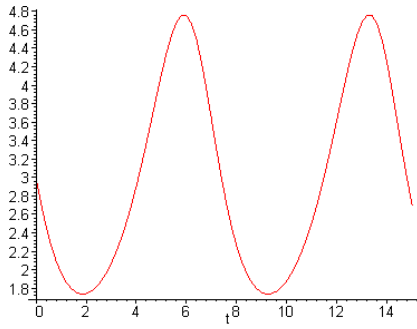

$x(0) = 3$  and  $y(0) = 3.5$  :

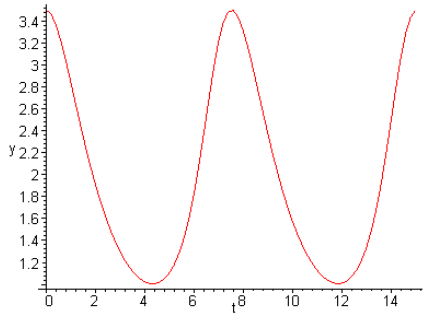
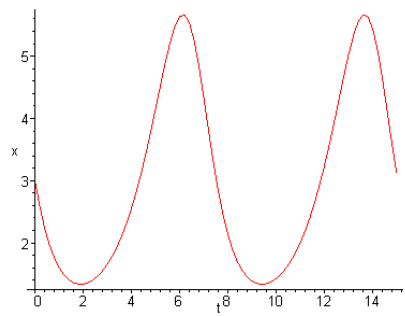



$x(0) = 3$  and  $y(0) = 4.0$  :

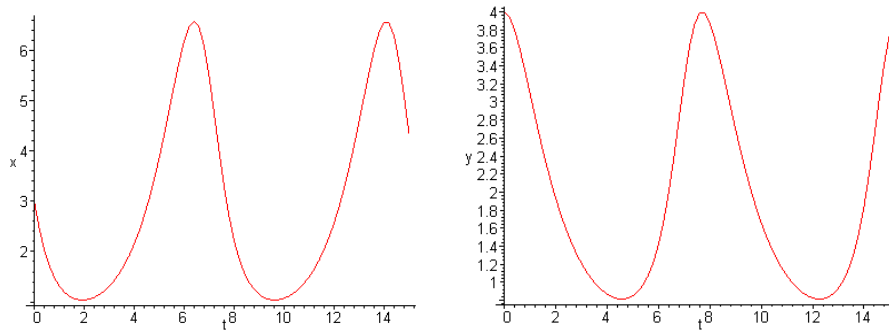

It is evident that the mean values *increase* as the amplitude increases. That is, the mean values increase as the initial conditions move farther from the critical point.

12. The system of equations in model (1) is given by

$$\begin{aligned} \frac{dx}{dt} &= x(a - \alpha y) \\ \frac{dy}{dt} &= y(-c + \gamma x). \end{aligned}$$

Based on the hypothesis, let the *death* rate of the insect population and the predators be  $px$  and  $qy$ , respectively. The modified system of equations becomes

$$\begin{aligned} \frac{dx}{dt} &= x(a - \alpha y) - px \\ \frac{dy}{dt} &= y(-c + \gamma x) - qy, \end{aligned}$$

in which  $p > 0, q > 0$ . The critical points are solutions of the system of equations

$$\begin{aligned} x(a - p - \alpha y) &= 0 \\ y(-c - q + \gamma x) &= 0. \end{aligned}$$

It is easy to see that the critical points are now at  $(0, 0)$  and  $\left(\frac{c+q}{\gamma}, \frac{a-p}{\alpha}\right)$ . Furthermore, since  $(c + q)/\gamma > c/\gamma$ , the equilibrium level of the insect population has *increased*. On the other hand, since  $(a - p)/\alpha < a/\alpha$ , equilibrium level of the predators has *decreased*. Indeed, the introduction of insecticide creates a potential to significantly affect the predator population ( $a \approx p$ ).

## Section 9.6

2. We consider the function  $V(x, y) = ax^2 + cy^2$ . The rate of change of  $V$  along any trajectory is

$$\begin{aligned}\dot{V} &= V_x \frac{dx}{dt} + V_y \frac{dy}{dt} \\ &= 2ax \left( -\frac{1}{2}x^3 + 2xy^2 \right) + 2cy(-y^3) \\ &= -ax^4 + 4ax^2y^2 - 2cy^4.\end{aligned}$$

Let  $u = x^2$ ,  $v = y^2$ ,  $\alpha = -a$ ,  $\beta = 4a$ , and  $\gamma = -2c$ . We then have

$$-ax^4 + 4ax^2y^2 - 2cy^4 = \alpha u^2 + \beta uv + \gamma v^2.$$

If  $a > 0$  and  $c > 0$ , then  $V(x, y)$  is *positive definite*. Furthermore,  $\alpha < 0$ . Recall that Theorem 9.6.4 asserts that if  $4\alpha\gamma - \beta^2 = 8ac - 16a^2 > 0$ , then the function

$$\alpha u^2 + \beta uv + \gamma v^2$$

is *negative definite*. Hence if  $c > 2a$ , then  $\dot{V}(x, y)$  is *negative definite*. One such example is  $V(x, y) = x^2 + 3y^2$ . It follows from Theorem 9.6.1 that the origin is an asymptotically stable critical point.

4. Given  $V(x, y) = ax^2 + cy^2$ , the rate of change of  $V$  along any trajectory is

$$\begin{aligned}\dot{V} &= V_x \frac{dx}{dt} + V_y \frac{dy}{dt} \\ &= 2ax(x^3 - y^3) + 2cy(2xy^2 + 4x^2y + 2y^3) \\ &= 2ax^4 + (4c - 2a)xy^3 + 8cx^2y^2 + 4cy^4.\end{aligned}$$

Setting  $a = 2c$ ,

$$\begin{aligned}\dot{V} &= 4cx^4 + 8cx^2y^2 + 4cy^4 \\ &\geq 4cx^4 + 4cy^4.\end{aligned}$$

As long as  $a = 2c > 0$ , the function  $V(x, y)$  is *positive definite* and  $\dot{V}(x, y)$  is also *positive definite*. It follows from Theorem 9.6.2 that  $(0, 0)$  is an unstable critical point.

5. Given  $V(x, y) = c(x^2 + y^2)$ , the rate of change of  $V$  along any trajectory is

$$\begin{aligned}\dot{V} &= V_x \frac{dx}{dt} + V_y \frac{dy}{dt} \\ &= 2cx[y - xf(x, y)] + 2cy[-x - yf(x, y)] \\ &= -2c(x^2 + y^2)f(x, y).\end{aligned}$$

If  $c > 0$ , then  $V(x, y)$  is *positive definite*. Furthermore, if  $f(x, y)$  is *positive* in some neighborhood of the origin, then  $\dot{V}(x, y)$  is *negative definite*. Theorem 9.6.1 asserts that

the origin is an asymptotically stable critical point.

On the other hand, if  $f(x, y)$  is *negative* in some neighborhood of the origin, then  $V(x, y)$  and  $\dot{V}(x, y)$  are both *positive definite*. It follows from Theorem 9.6.2 that the origin is an unstable critical point.

9(a). Letting  $x = u$  and  $y = u'$ , we obtain the system of equations

$$\begin{aligned}\frac{dx}{dt} &= y \\ \frac{dy}{dt} &= -g(x) - y.\end{aligned}$$

Since  $g(0) = 0$ , it is evident that  $(0, 0)$  is a critical point of the system. Consider the function

$$V(x, y) = \frac{1}{2}y^2 + \int_0^x g(s)ds.$$

It is clear that  $V(0, 0) = 0$ . Since  $g(u)$  is an *odd* function in a neighborhood of  $u = 0$ ,

$$\int_0^x g(s)ds > 0 \text{ for } x > 0,$$

and

$$\int_0^x g(s)ds = - \int_x^0 g(s)ds > 0 \text{ for } x < 0.$$

Therefore  $V(x, y)$  is *positive definite*.

The rate of change of  $V$  along any trajectory is

$$\begin{aligned}\dot{V} &= V_x \frac{dx}{dt} + V_y \frac{dy}{dt} \\ &= g(x) \cdot (y) + y[-g(x) - y] \\ &= -y^2.\end{aligned}$$

It follows that  $\dot{V}(x, y)$  is only *negative semidefinite*. Hence the origin is a *stable* critical point.

(b). Given

$$V(x, y) = \frac{1}{2}y^2 + \frac{1}{2}y \sin(x) + \int_0^x \sin(s)ds,$$

It is easy to see that  $V(0, 0) = 0$ . The rate of change of  $V$  along any trajectory is

$$\begin{aligned}
 \dot{V} &= V_x \frac{dx}{dt} + V_y \frac{dy}{dt} \\
 &= \left[ \sin x + \frac{y}{2} \cos x \right] (y) + \left[ y + \frac{1}{2} \sin x \right] [-\sin x - y] \\
 &= \frac{1}{2} y^2 \cos x - \frac{1}{2} \sin^2 x - \frac{y}{2} \sin x - y^2.
 \end{aligned}$$

For  $-\pi/2 < x < \pi/2$ , we can write  $\sin x = x - \alpha x^3/6$  and  $\cos x = 1 - \beta x^2/2$ , in which  $\alpha = \alpha(x)$ ,  $\beta = \beta(x)$ . Note that  $0 < \alpha, \beta < 1$ . Then

$$\dot{V}(x, y) = \frac{y^2}{2} \left( 1 - \frac{\beta x^2}{2} \right) - \frac{1}{2} \left( x - \frac{\alpha x^3}{6} \right)^2 - \frac{y}{2} \left( x - \frac{\alpha x^3}{6} \right) - y^2.$$

Using polar coordinates,

$$\begin{aligned}
 \dot{V}(r, \theta) &= -\frac{r^2}{2} [1 + \sin \theta \cos \theta + h(r, \theta)] \\
 &= -\frac{r^2}{2} \left[ 1 + \frac{1}{2} \sin 2\theta + h(r, \theta) \right].
 \end{aligned}$$

It is easy to show that

$$|h(r, \theta)| \leq \frac{1}{2} r^2 + \frac{1}{72} r^4.$$

So if  $r$  is sufficiently small, then  $|h(r, \theta)| < 1/2$  and  $|\frac{1}{2} \sin 2\theta + h(r, \theta)| < 1$ . Hence  $\dot{V}(x, y)$  is negative definite.

Now we show that  $V(x, y)$  is positive definite. Since  $g(u) = \sin u$ ,

$$V(x, y) = \frac{1}{2} y^2 + \frac{1}{2} y \sin(x) + 1 - \cos x.$$

This time we set

$$\cos x = 1 - \frac{x^2}{2} + \gamma \frac{x^4}{24}.$$

Note that  $0 < \gamma < 1$  for  $-\pi/2 < x < \pi/2$ . Converting to polar coordinates,

$$\begin{aligned}
 V(r, \theta) &= \frac{r^2}{2} \left[ 1 + \sin \theta \cos \theta - \frac{r^2}{12} \sin \theta \cos^3 \theta - \gamma \frac{r^2}{24} \cos^4 \theta \right] \\
 &= \frac{r^2}{2} \left[ 1 + \frac{1}{2} \sin 2\theta - \frac{r^2}{12} \sin \theta \cos^3 \theta - \gamma \frac{r^2}{24} \cos^4 \theta \right].
 \end{aligned}$$

Now

$$-\frac{r^2}{12} \sin \theta \cos^3 \theta - \gamma \frac{r^2}{24} \cos^4 \theta > -\frac{1}{8} \text{ for } r < 1.$$

It follows that when  $r > 0$ ,

$$V(r, \theta) > \frac{r^2}{2} \left[ \frac{7}{8} + \frac{1}{2} \sin 2\theta \right] \geq \frac{3r^2}{16} > 0.$$

Therefore  $V(x, y)$  is indeed *positive definite*, and by Theorem 9.6.1, the origin is an asymptotically stable critical point.

12(a). We consider the linear system

$$\begin{pmatrix} x \\ y \end{pmatrix}' = \begin{pmatrix} a_{11} & a_{12} \\ a_{21} & a_{22} \end{pmatrix} \begin{pmatrix} x \\ y \end{pmatrix}.$$

Let  $V(x, y) = Ax^2 + Bxy + Cy^2$ , in which

$$\begin{aligned} A &= -\frac{a_{21}^2 + a_{22}^2 + (a_{11}a_{22} - a_{12}a_{21})}{2\Delta} \\ B &= \frac{a_{12}a_{22} + a_{11}a_{21}}{\Delta} \\ C &= -\frac{a_{11}^2 + a_{12}^2 + (a_{11}a_{22} - a_{12}a_{21})}{2\Delta}, \end{aligned}$$

and  $\Delta = (a_{11} + a_{22})(a_{11}a_{22} - a_{12}a_{21})$ . Based on the hypothesis, the coefficients  $A$  and  $B$  are negative. Therefore, except for the origin,  $V(x, y)$  is *negative* on each of the coordinate axes. Along each trajectory,

$$\begin{aligned} \dot{V} &= (2Ax + By)(a_{11}x + a_{12}y) + (2Cy + Bx)(a_{21}x + a_{22}y) \\ &= -x^2 - y^2. \end{aligned}$$

Hence  $\dot{V}(x, y)$  is *negative definite*. Theorem 9.6.2 asserts that the origin is an *unstable* critical point.

(b). We now consider the system

$$\begin{pmatrix} x \\ y \end{pmatrix}' = \begin{pmatrix} a_{11} & a_{12} \\ a_{21} & a_{22} \end{pmatrix} \begin{pmatrix} x \\ y \end{pmatrix} + \begin{pmatrix} F_1(x, y) \\ G_1(x, y) \end{pmatrix},$$

in which  $F_1(x, y)/r \rightarrow 0$  and  $G_1(x, y)/r \rightarrow 0$  as  $r \rightarrow 0$ . Let

$$V(x, y) = Ax^2 + Bxy + Cy^2,$$

in which

$$\begin{aligned}
 A &= \frac{a_{21}^2 + a_{22}^2 + (a_{11}a_{22} - a_{12}a_{21})}{2\Delta} \\
 B &= -\frac{a_{12}a_{22} + a_{11}a_{21}}{\Delta} \\
 C &= \frac{a_{11}^2 + a_{12}^2 + (a_{11}a_{22} - a_{12}a_{21})}{2\Delta},
 \end{aligned}$$

and  $\Delta = (a_{11} + a_{22})(a_{11}a_{22} - a_{12}a_{21})$ . Based on the hypothesis,  $A, B > 0$ . Except for the origin,  $V(x, y)$  is *positive* on each of the coordinate axes. Along each trajectory,

$$\dot{V} = x^2 + y^2 + (2Ax + By)F_1(x, y) + (2Cy + Bx)G_1(x, y).$$

Converting to polar coordinates, for  $r \neq 0$ ,

$$\begin{aligned}
 \dot{V} &= r^2 + r(2A\cos\theta + B\sin\theta)F_1 + r(2C\sin\theta + B\cos\theta)G_1 \\
 &= r^2 + r^2 \left[ (2A\cos\theta + B\sin\theta) \frac{F_1}{r} + (2C\sin\theta + B\cos\theta) \frac{G_1}{r} \right].
 \end{aligned}$$

Since the system is *almost linear*, there is an  $R$  such that

$$\left| (2A\cos\theta + B\sin\theta) \frac{F_1}{r} + (2C\sin\theta + B\cos\theta) \frac{G_1}{r} \right| < \frac{1}{2},$$

and hence

$$(2A\cos\theta + B\sin\theta) \frac{F_1}{r} + (2C\sin\theta + B\cos\theta) \frac{G_1}{r} > -\frac{1}{2}$$

for  $r < R$ . It follows that

$$\dot{V} > \frac{1}{2}r^2$$

as long as  $0 < r < R$ . Hence  $\dot{V}$  is *positive definite* on the domain

$$D = \{(x, y) \mid x^2 + y^2 < R^2\}.$$

By Theorem 9.6.2, the origin is an *unstable* critical point.

## Section 9.7

3. The equilibrium solutions of the ODE

$$\frac{dr}{dt} = r(r-1)(r-3)$$

are given by  $r_1 = 0$ ,  $r_2 = 1$  and  $r_3 = 3$ . Note that

$$\frac{dr}{dt} > 0 \text{ for } 0 < r < 1 \text{ and } r > 3; \quad \frac{dr}{dt} < 0 \text{ for } 1 < r < 3.$$

$r = 0$  corresponds to an *unstable* critical point. The equilibrium solution  $r_2 = 1$  is *asymptotically stable*, whereas the equilibrium solution  $r_3 = 3$  is *unstable*. Since the critical values are *isolated*, a limit cycle is given by

$$r = 1, \theta = t + t_0$$

which is *asymptotically stable*. Another periodic solution is found to be

$$r = 3, \theta = t + t_0$$

which is *unstable*.

5. The equilibrium solutions of the ODE

$$\frac{dr}{dt} = \sin \pi r$$

are given by  $r = n$ ,  $n = 0, 1, 2, \dots$ . Based on the *sign* of  $r'$  in the neighborhood of each critical value, the equilibrium solutions  $r = 2k$ ,  $k = 1, 2, \dots$  correspond to *unstable* periodic solutions, with  $\theta = t + t_0$ . The equilibrium solutions  $r = 2k + 1$ ,  $k = 0, 1, 2, \dots$  correspond to *stable* limit cycles, with  $\theta = t + t_0$ . The solution  $r = 0$  represents an *unstable* critical point.

10. Given  $F(x, y) = a_{11}x + a_{12}y$  and  $G(x, y) = a_{21}x + a_{22}y$ , it follows that

$$F_x + G_y = a_{11} + a_{22}.$$

Based on the hypothesis,  $F_x + G_y$  is either *positive* or *negative* on the entire plane. By Theorem 9.7.2, the system cannot have a nontrivial periodic solution.

12. Given that  $F(x, y) = -2x - 3y - xy^2$  and  $G(x, y) = y + x^3 - x^2y$ ,

$$F_x + G_y = -1 - x^2 - y^2.$$

Since  $F_x + G_y < 0$  on the entire plane, Theorem 9.7.2 asserts that the system cannot have a nontrivial periodic solution.

14(a). Based on the given graphs, the following table shows the estimated values:

$\mu = 0.2$	$T \approx 6.29$
$\mu = 1.0$	$T \approx 6.66$
$\mu = 5.0$	$T \approx 11.60$

(b). The initial conditions were chosen as  $x(0) = 2, y(0) = 0$ .

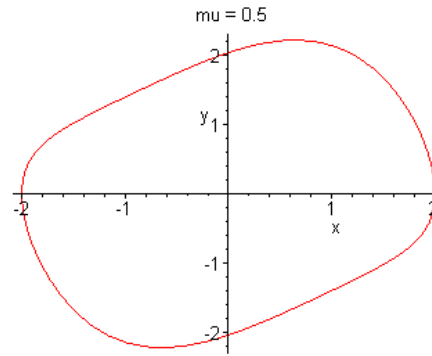
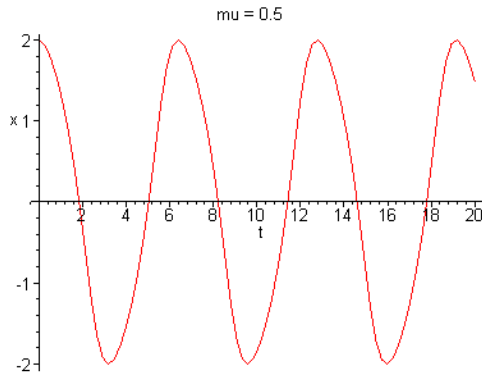

$T \approx 6.38$ .

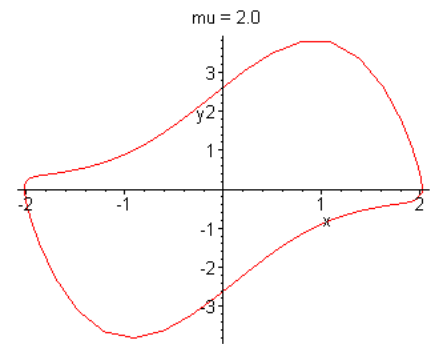
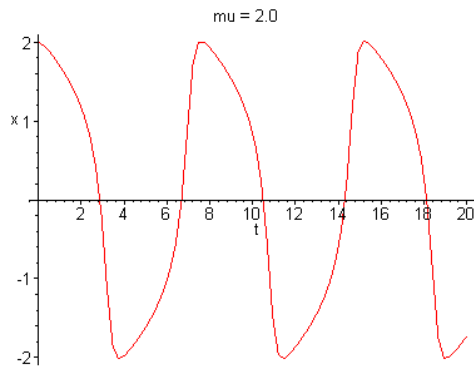

$T \approx 7.65$ .

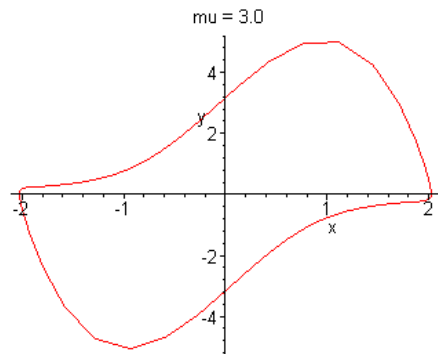
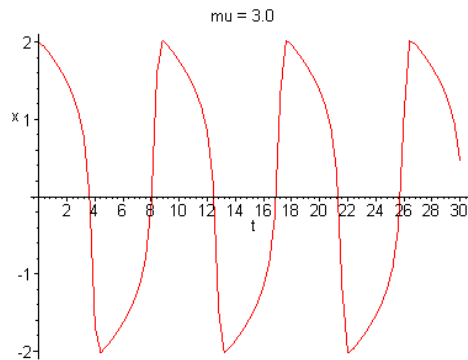



$T \approx 8.86$ .

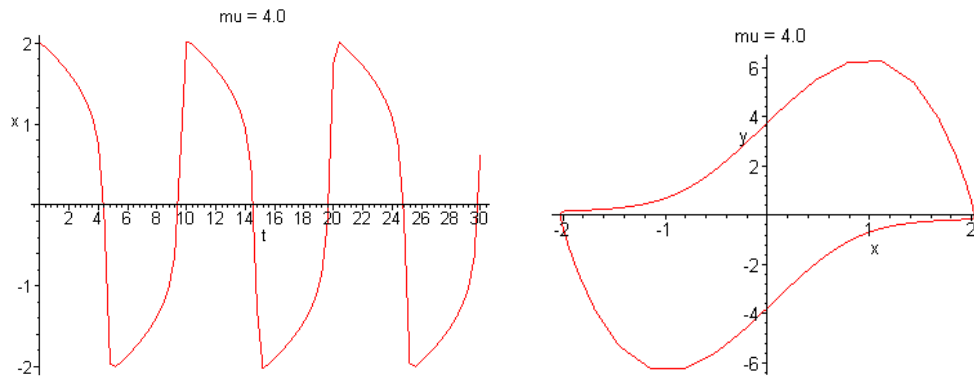

$T \approx 10.25$ .

(c). The period,  $T$ , appears to be a *quadratic* function of  $\mu$ .

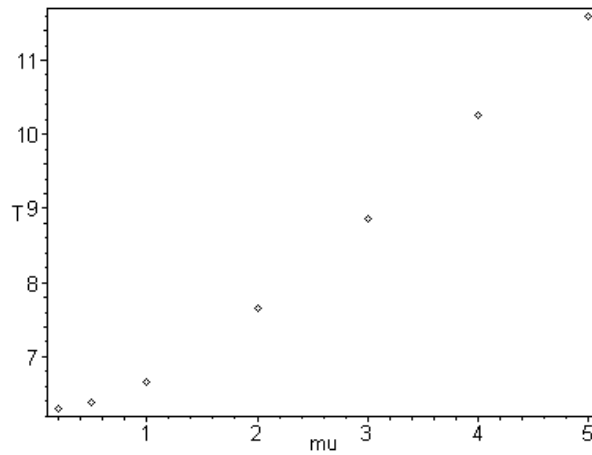

15(a). Setting  $x = u$  and  $y = u'$ , we obtain the system of equations

$$\begin{aligned} \frac{dx}{dt} &= y \\ \frac{dy}{dt} &= -x + \mu \left( 1 - \frac{1}{3} y^2 \right) y. \end{aligned}$$

(b). Evidently,  $y = 0$ . It follows that  $x = 0$ . Hence the only critical point of the system is at  $(0, 0)$ . The components of the vector field are infinitely differentiable everywhere. Therefore the system is *almost linear*.

The Jacobian matrix of the vector field is

$$\mathbf{J} = \begin{pmatrix} 0 & 1 \\ -1 & \mu - \mu y^2 \end{pmatrix}.$$

At the critical point  $(0, 0)$ , the coefficient matrix of the linearized system is

$$\mathbf{J}(0, 0) = \begin{pmatrix} 0 & 1 \\ -1 & \mu \end{pmatrix},$$

with eigenvalues

$$r_{1,2} = \frac{\mu}{2} \pm \frac{1}{2} \sqrt{\mu^2 - 4}.$$

If  $\mu = 0$ , the equation reduces to the ODE for a simple harmonic oscillator. For the case  $0 < \mu < 2$ , the eigenvalues are *complex*, and the critical point is an *unstable spiral*. For  $\mu \geq 2$ , the eigenvalues are *real*, and the origin is an *unstable node*.

(c). The initial conditions were chosen as  $x(0) = 2$ ,  $y(0) = 0$ .

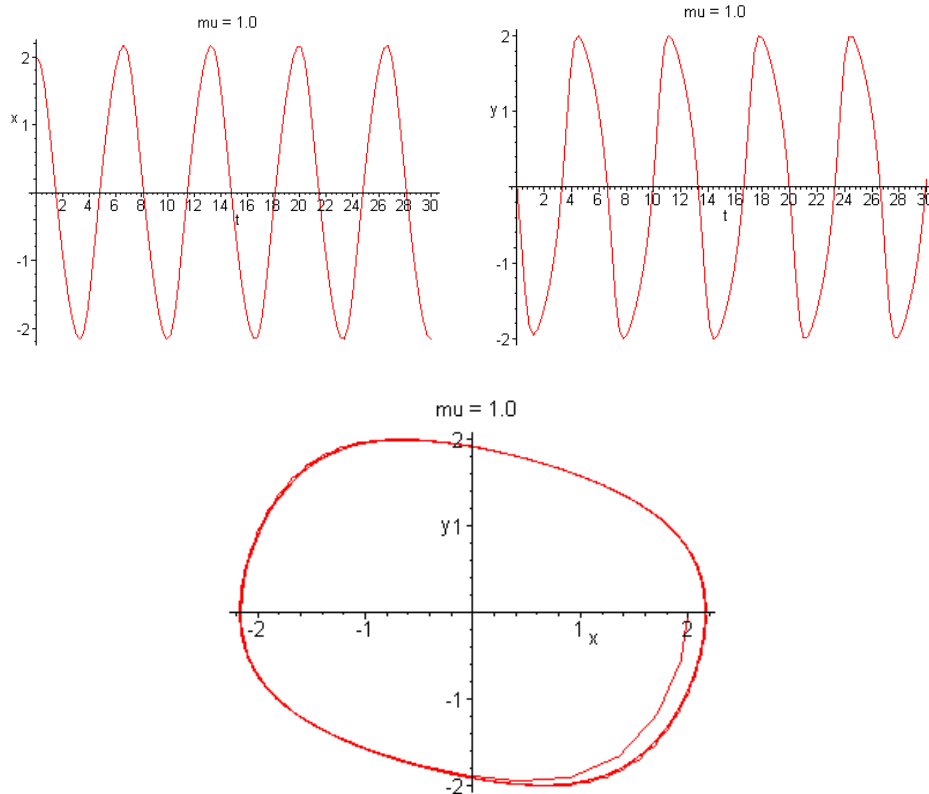

$A \approx 2.16$  and  $T \approx 6.65$ .

(d).

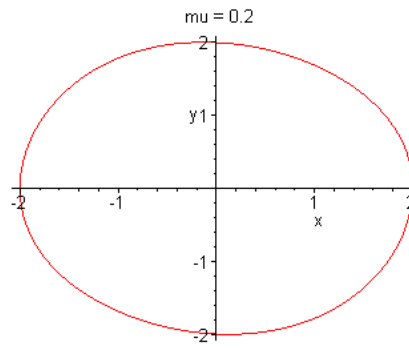
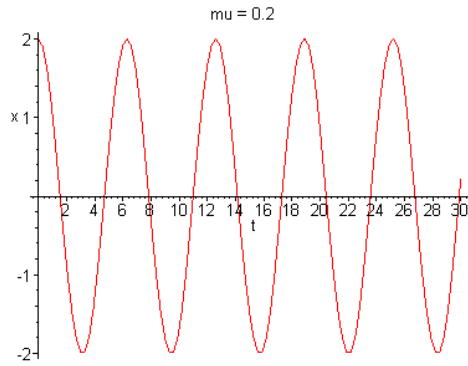

$A \approx 2.00$  and  $T \approx 6.30$ .

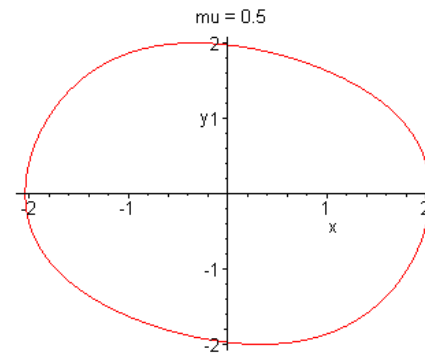
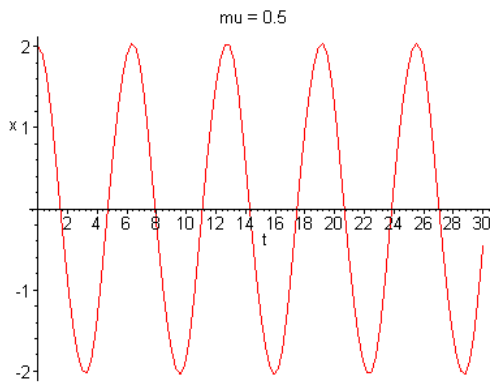

$A \approx 2.04$  and  $T \approx 6.38$ .

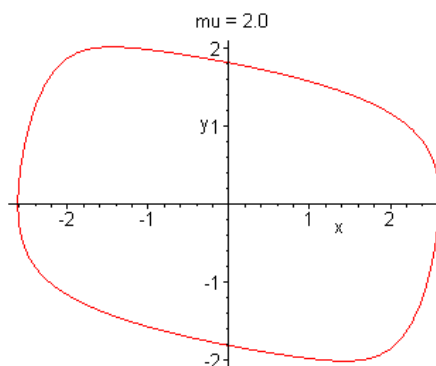
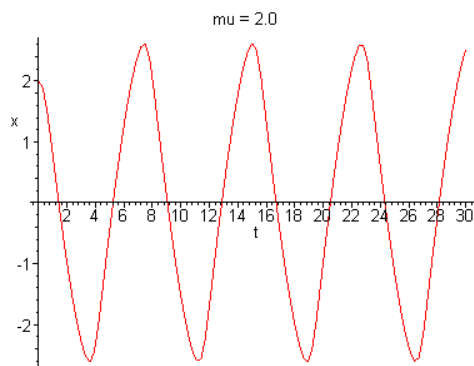

$A \approx 2.6$  and  $T \approx 7.62$ .

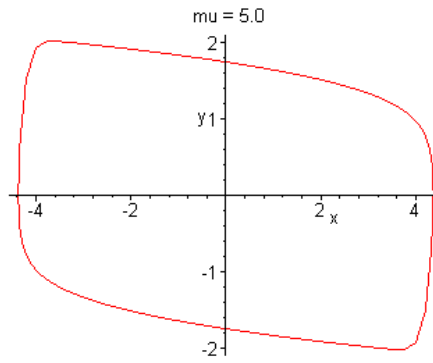
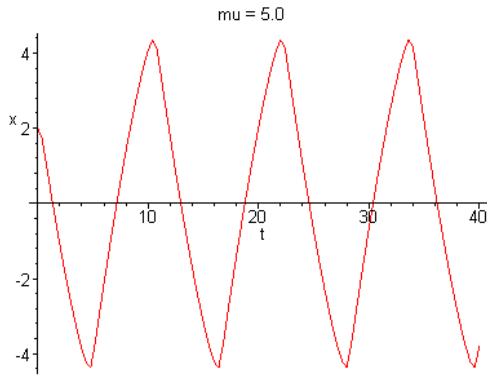

$A \approx 4.37$  and  $T \approx 11.61$ .

(e).

	$A$	$T$
$\mu = 0.2$	2.00	6.30
$\mu = 0.5$	2.04	6.38
$\mu = 1.0$	2.16	6.65
$\mu = 2.0$	2.6	7.62
$\mu = 5.0$	4.37	11.61

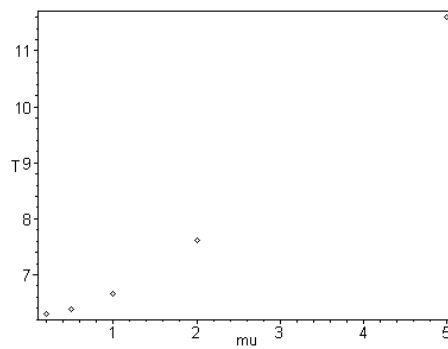
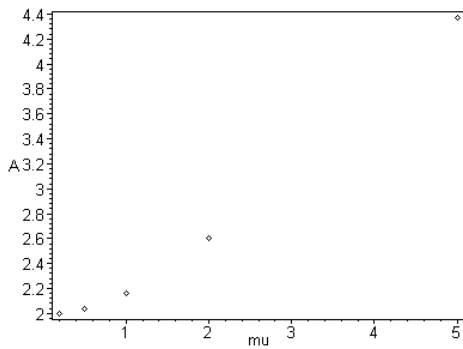

## Section 9.8

6.  $r = 28$ , with initial point  $(5, 5, 5)$ :

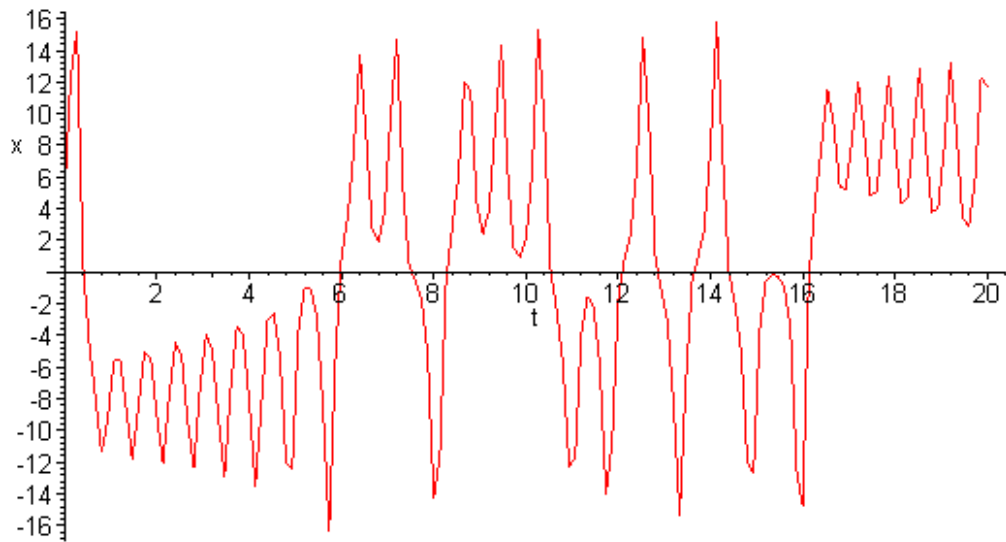

$r = 28$ , with initial point  $(5.01, 5, 5)$ :

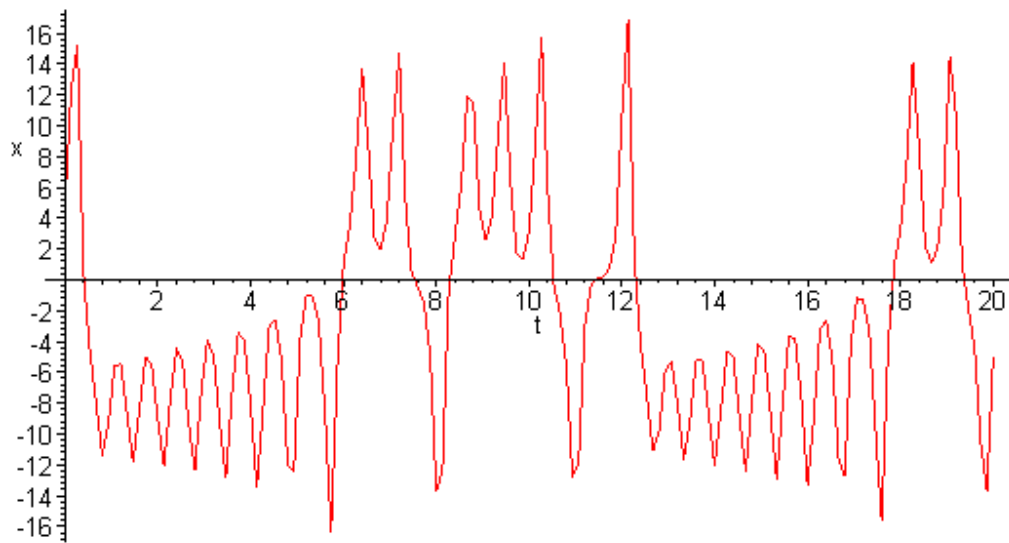

7.  $r = 28$  :

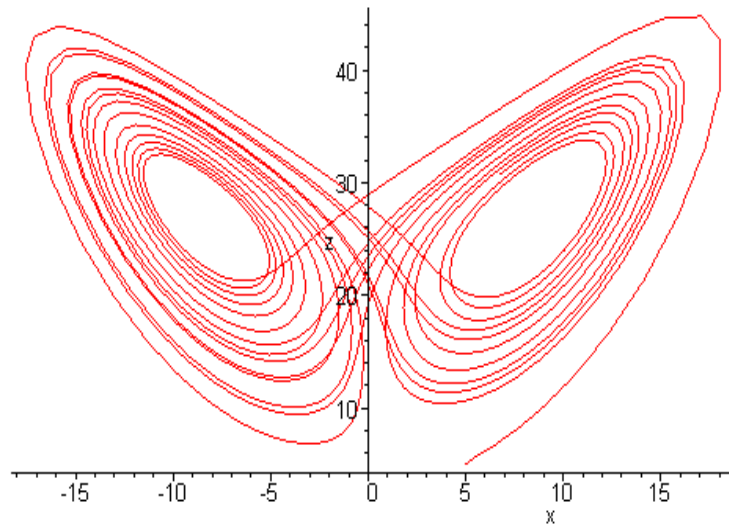
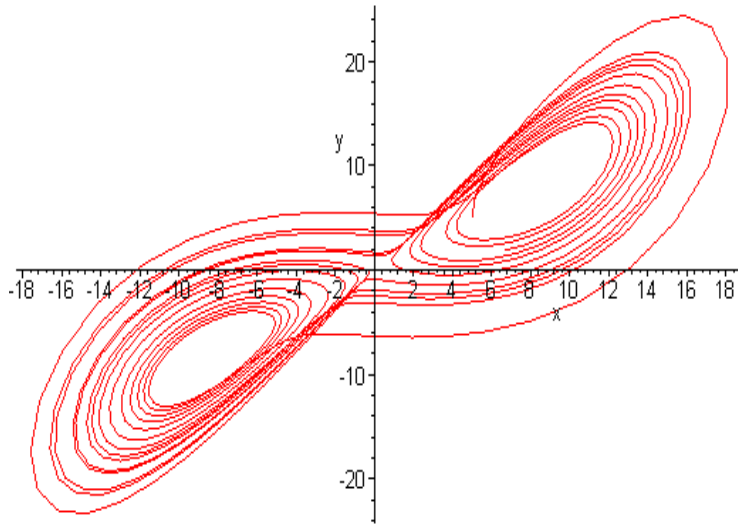

9(a).  $r = 100$ , initial point  $(-5, -13, 55)$  :

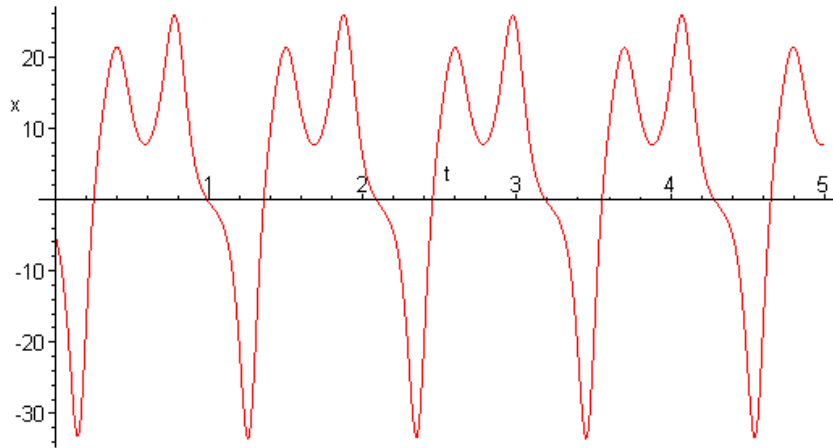
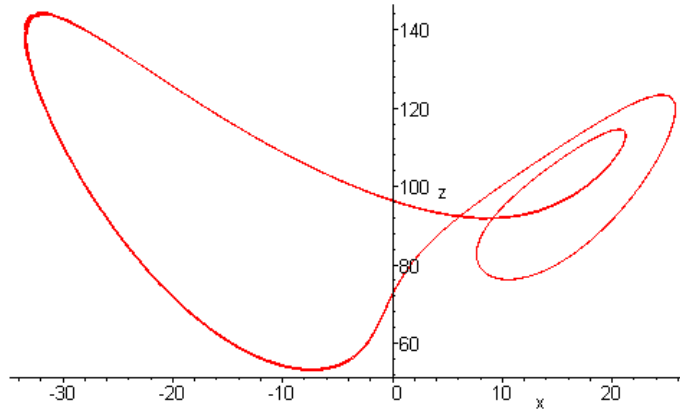

The period appears to be  $T \approx 1.12$ .

(b).  $r = 99.94$ , initial point  $(-5, -13, 55)$  :

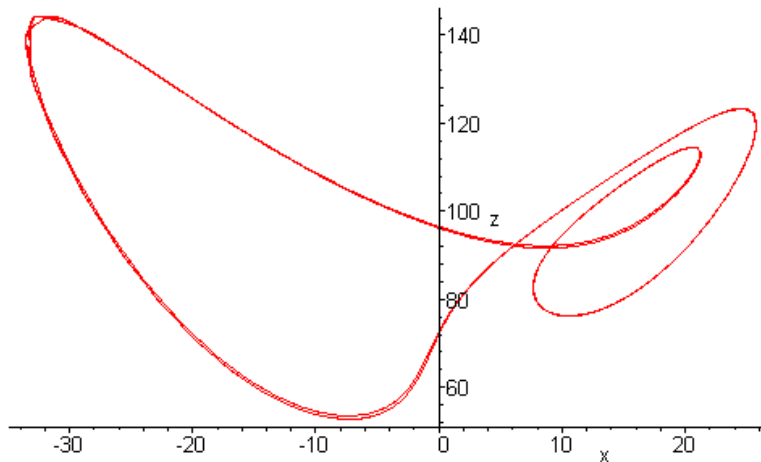

The periodic trajectory appears to have split into two strands, indicative of a period-doubling. Closer examination reveals that the peak values of  $z(t)$  are slightly different:

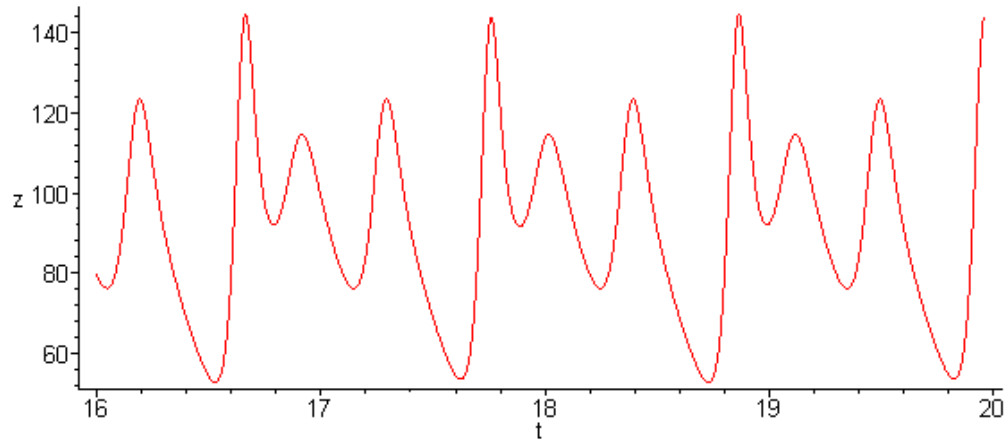

$r = 99.7$ , initial point  $(-5, -13, 55)$  :

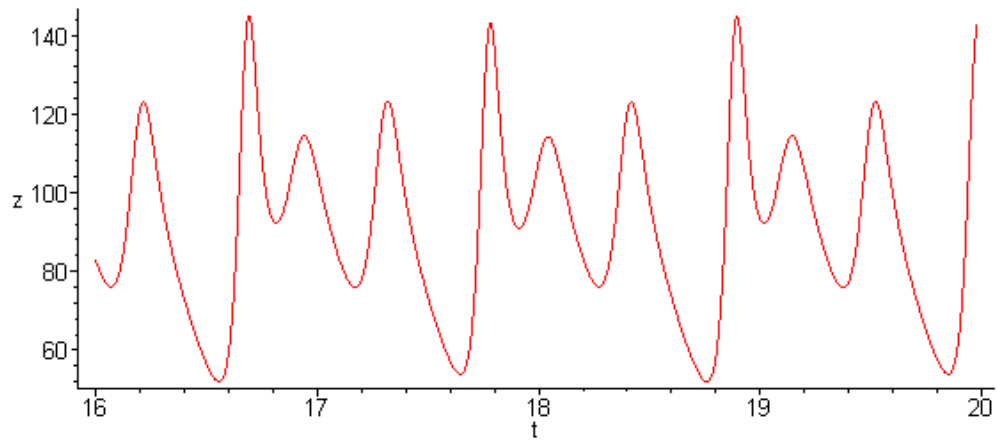
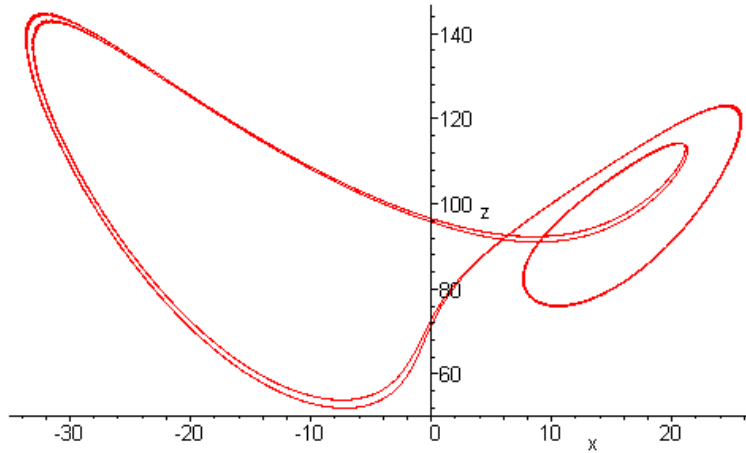



(c).  $r = 99.6$ , initial point  $(-5, -13, 55)$  :

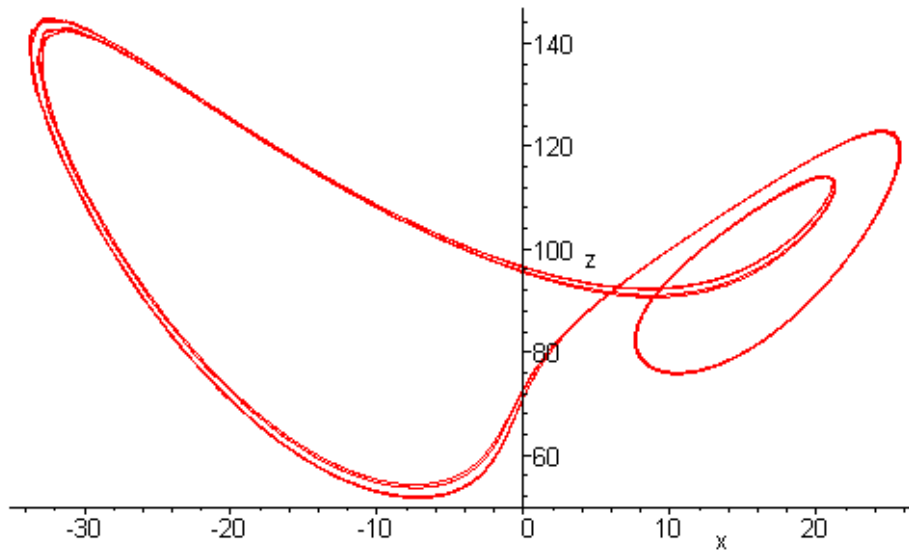

The strands again appear to have split.

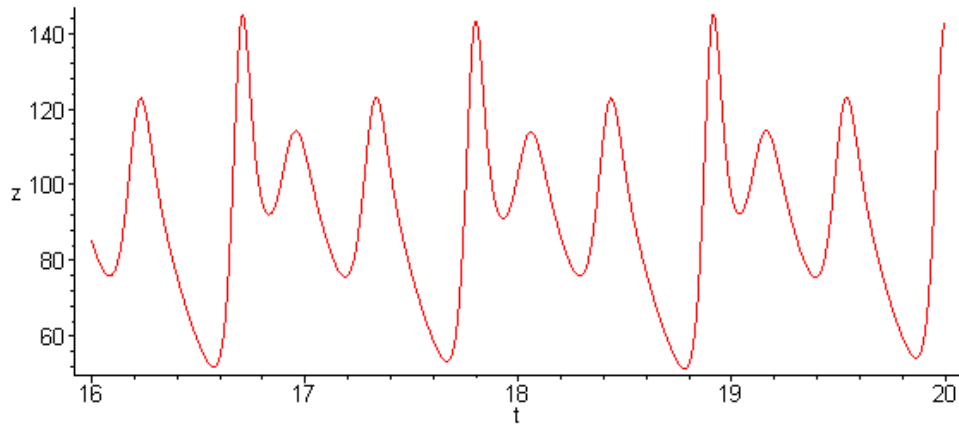

Closer examination reveals that the peak values of  $z(t)$  are different:

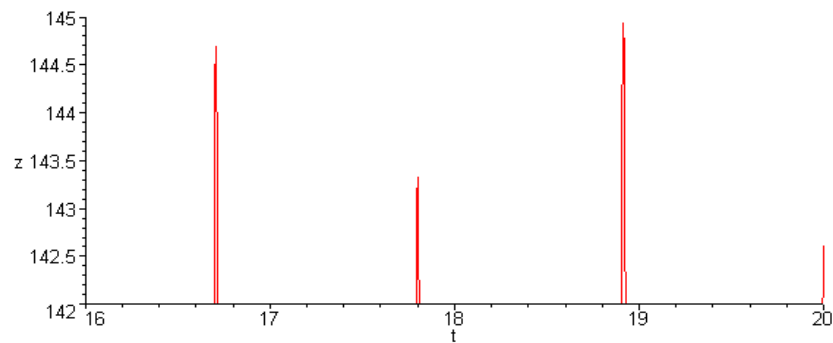

10(a).  $r = 100.5$ , initial point  $(-5, -13, 55)$  :

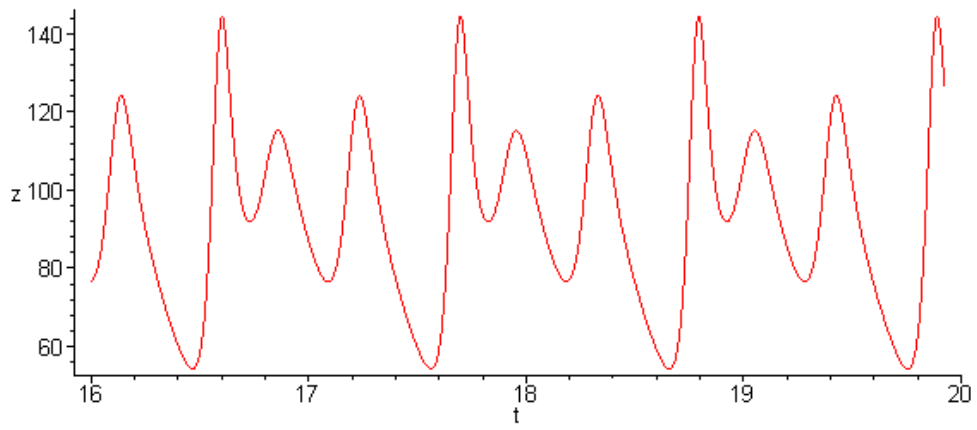
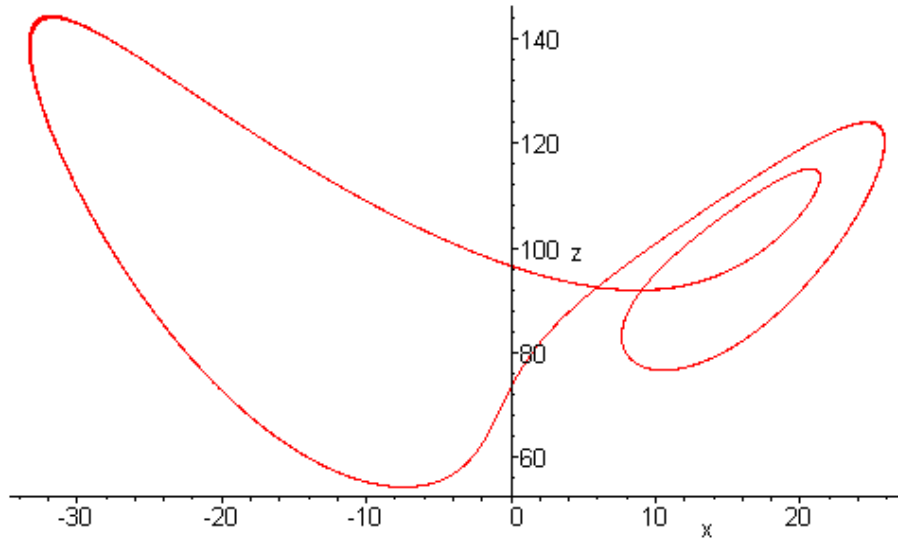

$r = 100.7$ , initial point  $(-5, -13, 55)$  :

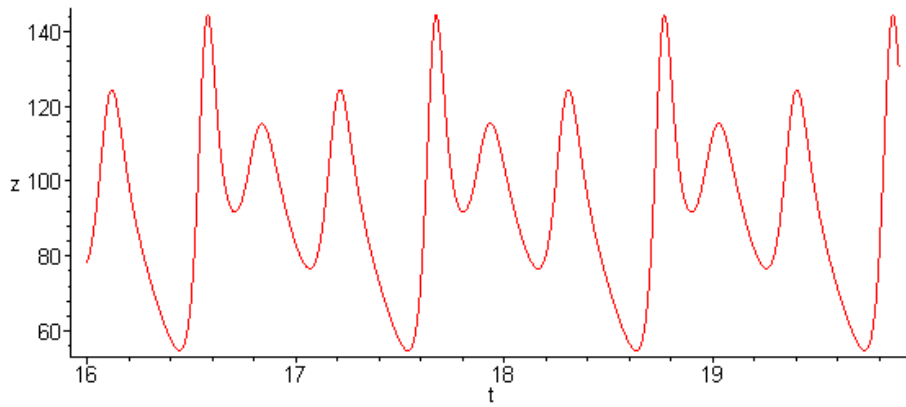
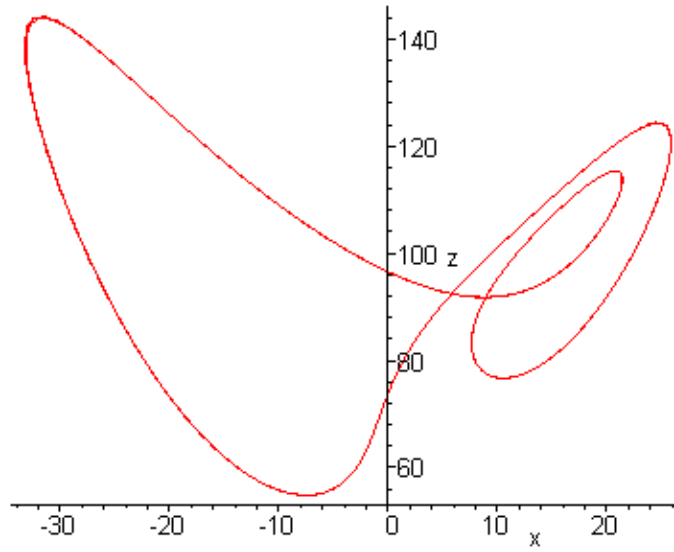

(b).  $r = 100.8$ , initial point  $(-5, -13, 55)$  :

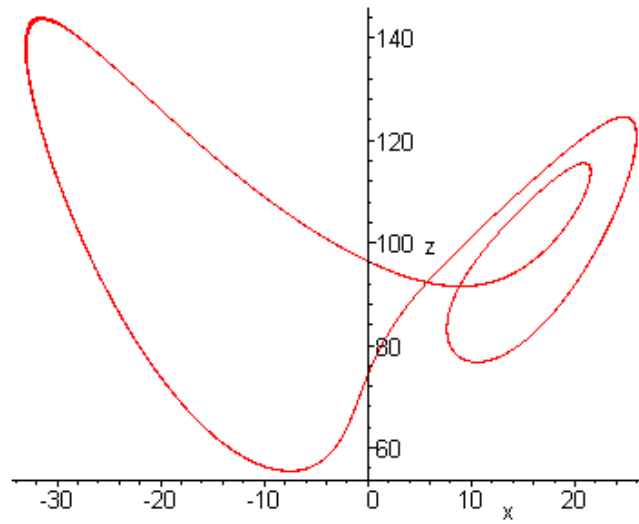

$r = 100.81$ , initial point  $(-5, -13, 55)$  :

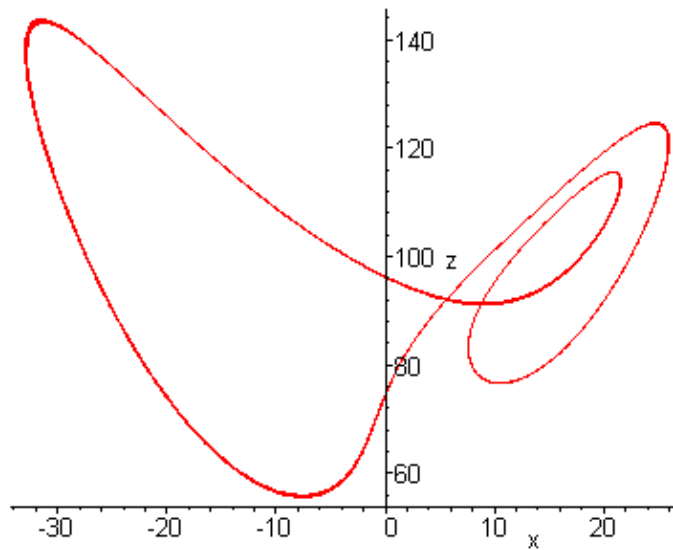

The strands of the periodic trajectory are beginning to split apart.

$r = 100.82$ , initial point  $(-5, -13, 55)$  :

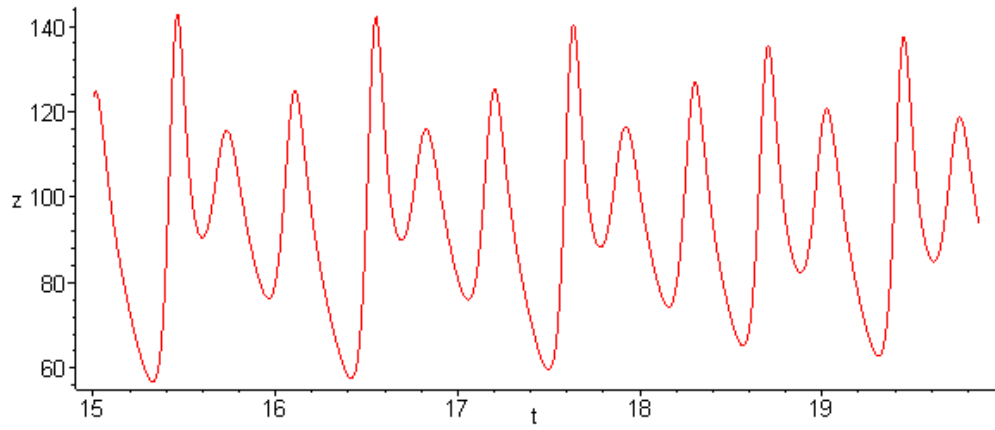
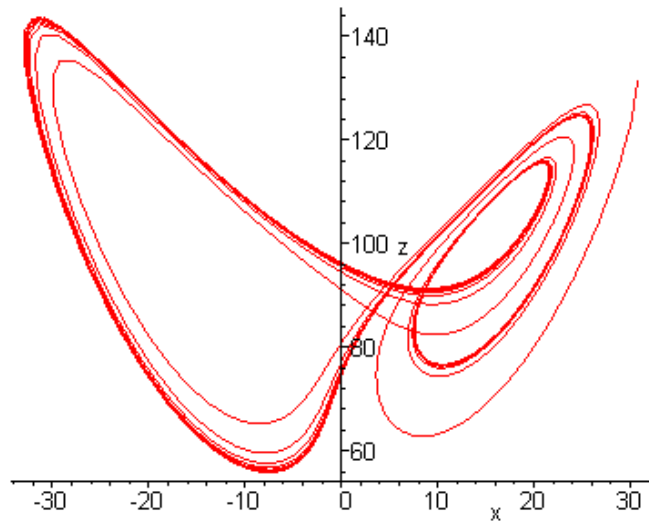

$r = 100.83$ , initial point  $(-5, -13, 55)$  :

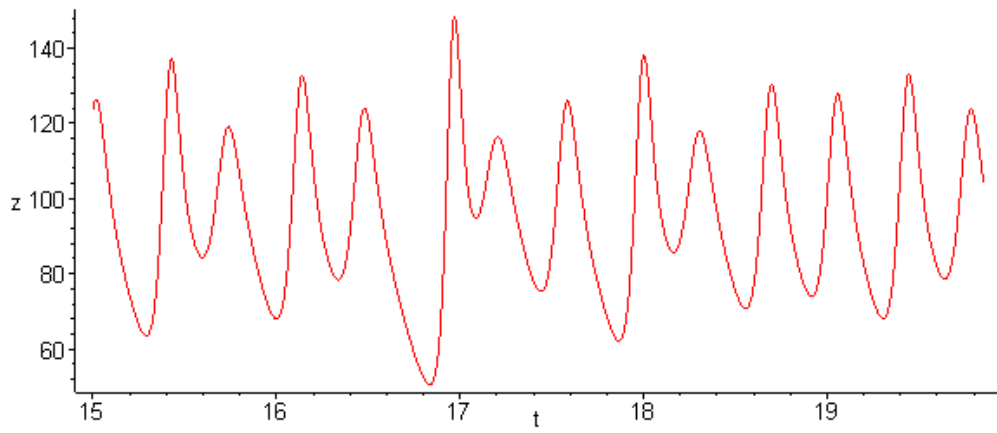
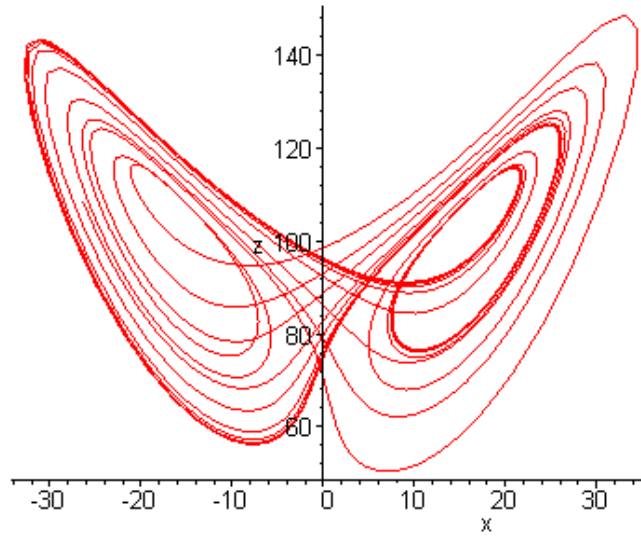

$r = 100.84$ , initial point  $(-5, -13, 55)$  :

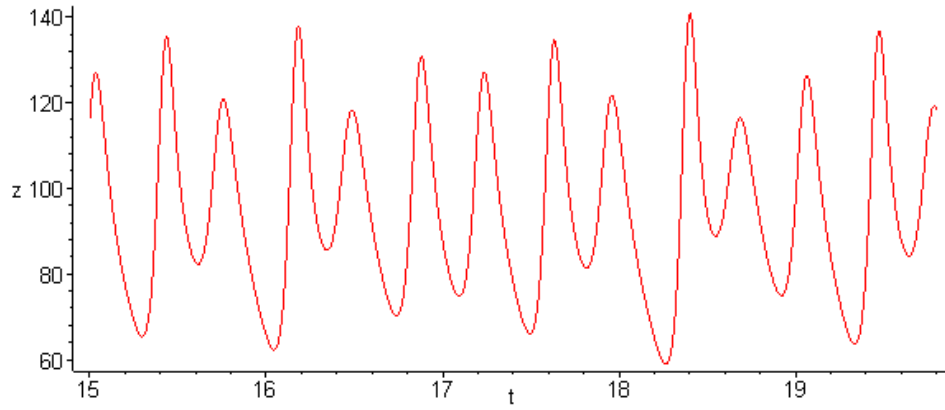
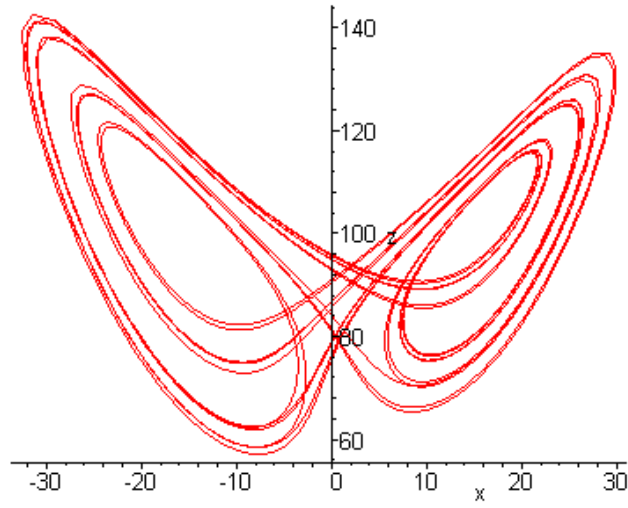

## Chapter Ten

### Section 10.1

1. The general solution of the ODE is  $y(x) = c_1 \cos x + c_2 \sin x$ . Imposing the first boundary condition, it is necessary that  $c_1 = 0$ . Therefore  $y(x) = c_2 \sin x$ . Taking its derivative,  $y'(x) = c_2 \cos x$ . Imposing the second boundary condition, we require that  $c_2 \cos \pi = 1$ . The latter equation is satisfied only if  $c_2 = -1$ . Hence the solution of the boundary value problem is  $y(x) = -\sin x$ .

4. The general solution of the differential equation is  $y(x) = c_1 \cos x + c_2 \sin x$ . It follows that  $y'(x) = -c_1 \sin x + c_2 \cos x$ . Imposing the first boundary condition, we find that  $c_2 = 1$ . Therefore  $y(x) = c_1 \cos x + \sin x$ . Imposing the second boundary condition, we require that  $c_1 \cos L + \sin L = 0$ . If  $\cos L \neq 0$ , that is, as long as  $L \neq (2k - 1)\pi/2$ , with  $k$  an integer, then  $c_1 = -\tan L$ . The solution of the boundary value problem is

$$y(x) = -\tan L \cos x + \sin x.$$

If  $\cos L = 0$ , the boundary condition results in  $\sin L = 0$ . The latter two equations are inconsistent, which implies that the BVP has no solution.

5. The general solution of the *homogeneous* differential equation is

$$y(x) = c_1 \cos x + c_2 \sin x.$$

Using any of a number of methods, including the *method of undetermined coefficients*, it is easy to show that a *particular solution* is  $Y(x) = x$ . Hence the general solution of the given differential equation is  $y(x) = c_1 \cos x + c_2 \sin x + x$ . The first boundary condition requires that  $c_1 = 0$ . Imposing the second boundary condition, it is necessary that  $c_2 \sin \pi + \pi = 0$ . The resulting equation has *no solution*. We conclude that the boundary value problem has no solution.

6. Using the *method of undetermined coefficients*, it is easy to show that the general solution of the ODE is  $y(x) = c_1 \cos \sqrt{2}x + c_2 \sin \sqrt{2}x + x/2$ . Imposing the first boundary condition, we find that  $c_1 = 0$ . The second boundary condition requires that  $c_2 \sin \sqrt{2}\pi + \pi/2 = 0$ . It follows that  $c_2 = -\pi/2 \sin \sqrt{2}\pi$ . Hence the solution of the boundary value problem is

$$y(x) = -\frac{\pi}{2 \sin \sqrt{2}\pi} \sin \sqrt{2}x + \frac{x}{2}.$$

8. The general solution of the *homogeneous* differential equation is

$$y(x) = c_1 \cos 2x + c_2 \sin 2x.$$

Using the method of undetermined coefficients, a *particular solution* is  $Y(x) = \sin x/3$ .



Hence the general solution of the given differential equation is

$$y(x) = c_1 \cos 2x + c_2 \sin 2x + \frac{1}{3} \sin x.$$

The first boundary condition requires that  $c_1 = 0$ . The second boundary requires that  $c_2 \sin 2\pi + \frac{1}{3} \sin \pi = 0$ . The latter equation is valid for *all* values of  $c_2$ . Therefore the solution of the boundary value problem is

$$y(x) = c_2 \sin 2x + \frac{1}{3} \sin x.$$

9. Using the *method of undetermined coefficients*, it is easy to show that the general solution of the ODE is  $y(x) = c_1 \cos 2x + c_2 \sin 2x + \cos x/3$ . It follows that  $y'(x) = -2c_1 \sin 2x + 2c_2 \cos 2x - \sin x/3$ . Imposing the first boundary condition, we find that  $c_2 = 0$ . The second boundary condition requires that

$$-2c_1 \sin 2\pi - \frac{1}{3} \sin \pi = 0.$$

The resulting equation is satisfied for all values of  $c_1$ . Hence the solution is the family of functions

$$y(x) = c_1 \cos 2x + \frac{1}{3} \cos x.$$

10. The general solution of the differential equation is

$$y(x) = c_1 \cos \sqrt{3}x + c_2 \sin \sqrt{3}x + \frac{1}{2} \cos x.$$

Its derivative is  $y'(x) = -\sqrt{3}c_1 \sin \sqrt{3}x + \sqrt{3}c_2 \cos \sqrt{3}x - \sin x/2$ . The first boundary condition requires that  $c_2 = 0$ . Imposing the second boundary condition, we obtain  $-\sqrt{3}c_1 \sin \sqrt{3}\pi = 0$ . It follows that  $c_1 = 0$ . Hence the solution of the BVP is  $y(x) = \cos x/2$ .

12. Assuming that  $\lambda > 0$ , we can set  $\lambda = \mu^2$ . The general solution of the differential equation is

$$y(x) = c_1 \cos \mu x + c_2 \sin \mu x,$$

so that  $y'(x) = -\mu c_1 \sin \mu x + \mu c_2 \cos \mu x$ . Imposing the first boundary condition, it follows that  $c_2 = 0$ . Therefore  $y(x) = c_1 \cos \mu x$ . The second boundary condition requires that  $c_1 \cos \mu\pi = 0$ . For a nontrivial solution, it is necessary that  $\cos \mu\pi = 0$ , that is,  $\mu\pi = (2n-1)\pi/2$ , with  $n = 1, 2, \dots$ . Therefore the *eigenvalues* are

$$\lambda_n = \frac{(2n-1)^2}{4}, \quad n = 1, 2, \dots$$

The corresponding *eigenfunctions* are given by

$$y_n = \cos \frac{(2n-1)x}{2}, \quad n = 1, 2, \dots$$

Assuming that  $\lambda < 0$ , we can set  $\lambda = -\mu^2$ . The general solution of the differential equation is

$$y(x) = c_1 \cosh \mu x + c_2 \sinh \mu x,$$

so that  $y'(x) = \mu c_1 \sinh \mu x + \mu c_2 \cosh \mu x$ . Imposing the first boundary condition, it follows that  $c_2 = 0$ . Therefore  $y(x) = c_1 \cosh \mu x$ . The second boundary condition requires that  $c_1 \cosh \mu \pi = 0$ , which results in  $c_1 = 0$ . Hence the only solution is the trivial solution. Finally, with  $\lambda = 0$ , the general solution of the ODE is

$$y(x) = c_1 x + c_2.$$

It is easy to show that the boundary conditions require that  $c_1 = c_2 = 0$ . Therefore all of the eigenvalues are *positive*.

13. Assuming that  $\lambda > 0$ , we can set  $\lambda = \mu^2$ . The general solution of the differential equation is

$$y(x) = c_1 \cos \mu x + c_2 \sin \mu x,$$

so that  $y'(x) = -\mu c_1 \sin \mu x + \mu c_2 \cos \mu x$ . Imposing the first boundary condition, it follows that  $c_2 = 0$ . The second boundary condition requires that  $c_1 \sin \mu \pi = 0$ . For a nontrivial solution, we must have  $\mu \pi = n\pi$ ,  $n = 1, 2, \dots$ . It follows that the *eigenvalues* are

$$\lambda_n = n^2, \quad n = 1, 2, \dots,$$

and the corresponding *eigenfunctions* are

$$y_n = \cos nx, \quad n = 1, 2, \dots$$

Assuming that  $\lambda < 0$ , we can set  $\lambda = -\mu^2$ . The general solution of the differential equation is

$$y(x) = c_1 \cosh \mu x + c_2 \sinh \mu x,$$

so that  $y'(x) = \mu c_1 \sinh \mu x + \mu c_2 \cosh \mu x$ . Imposing the first boundary condition, it follows that  $c_2 = 0$ . The second boundary condition requires that  $c_1 \sinh \mu \pi = 0$ . The latter equation is satisfied only for  $c_1 = 0$ .

Finally, for  $\lambda = 0$ , the solution is  $y(x) = c_1 x + c_2$ . Imposing the boundary conditions, we find that  $y(x) = c_2$ . Therefore  $\lambda = 0$  is *also* an eigenvalue, with corresponding eigenfunction  $y_0(x) = 1$ .

14. It can be shown, as in Prob. 12, that  $\lambda > 0$ . Setting  $\lambda = \mu^2$ , the general solution of the resulting ODE is

$$y(x) = c_1 \cos \mu x + c_2 \sin \mu x,$$

with  $y'(x) = -\mu c_1 \sin \mu x + \mu c_2 \cos \mu x$ . Imposing the first boundary condition, we find that  $c_2 = 0$ . Therefore  $y(x) = c_1 \cos \mu x$ . The second boundary condition requires that  $c_1 \cos \mu L = 0$ . For a nontrivial solution, it is necessary that  $\cos \mu L = 0$ , that is,  $\mu = (2n - 1)\pi/(2L)$ , with  $n = 1, 2, \dots$ . Therefore the *eigenvalues* are

$$\lambda_n = \frac{(2n - 1)^2 \pi^2}{4L^2}, \quad n = 1, 2, \dots.$$

The corresponding *eigenfunctions* are given by

$$y_n = \cos \frac{(2n - 1)\pi x}{2L}, \quad n = 1, 2, \dots.$$

16. Assuming that  $\lambda > 0$ , we can set  $\lambda = \mu^2$ . The general solution of the differential equation is

$$y(x) = c_1 \cosh \mu x + c_2 \sinh \mu x.$$

The first boundary condition requires that  $c_1 = 0$ . Therefore  $y(x) = c_2 \sinh \mu x$  and  $y'(x) = c_2 \cosh \mu x$ . Imposing the second boundary condition, it is necessary that  $c_2 \cosh \mu L = 0$ . The latter equation is valid only for  $c_2 = 0$ . The only solution is the trivial solution.

Assuming that  $\lambda > 0$ , we set  $\lambda = -\mu^2$ . The general solution of the resulting ODE is

$$y(x) = c_1 \cos \mu x + c_2 \sin \mu x.$$

Imposing the first boundary condition, we find that  $c_1 = 0$ . Hence  $y(x) = c_2 \sin \mu x$  and  $y'(x) = c_2 \cos \mu x$ . In order to satisfy the second boundary condition, it is necessary that  $c_2 \cos \mu L = 0$ . For a nontrivial solution,  $\mu = (2n - 1)\pi/(2L)$ , with  $n = 1, 2, \dots$ . Therefore the *eigenvalues* are

$$\lambda_n = -\frac{(2n - 1)^2 \pi^2}{4L^2}, \quad n = 1, 2, \dots.$$

The corresponding *eigenfunctions* are given by

$$y_n = \sin \frac{(2n - 1)\pi x}{2L}, \quad n = 1, 2, \dots.$$

Finally, for  $\lambda = 0$ , the general solution is *linear*. Based on the boundary conditions, it follows that  $y(x) = 0$ . Therefore all of the eigenvalues are negative.

17(a). Setting  $\lambda = \mu^2$ , write the general solution of the ODE  $y'' + \mu^2 y = 0$  as

$$y(x) = k_1 e^{i\mu x} + k_2 e^{-i\mu x}.$$

Imposing the boundary conditions  $y(0) = y(\pi) = 0$ , we obtain the system of equations

$$\begin{aligned} k_1 + k_2 &= 0 \\ k_1 e^{i\mu\pi} + k_2 e^{-i\mu\pi} &= 0. \end{aligned}$$

The system has a *nontrivial* solution if and only if the coefficient matrix is *singular*. Set the determinant equal to zero to obtain

$$e^{-i\mu\pi} - e^{i\mu\pi} = 0.$$

(b). Let  $\mu = \nu + i\sigma$ . Then  $i\mu\pi = i\nu\pi - \sigma\pi$ , and the previous equation can be written as

$$e^{\sigma\pi} e^{-i\nu\pi} - e^{-\sigma\pi} e^{i\nu\pi} = 0.$$

Using Euler's relation,  $e^{i\nu\pi} = \cos \nu\pi + i \sin \nu\pi$ , we obtain

$$e^{\sigma\pi}(\cos \nu - i \sin \nu) - e^{-\sigma\pi}(\cos \nu + i \sin \nu) = 0.$$

Equating the real and imaginary parts of the equation,

$$\begin{aligned} (e^{\sigma\pi} - e^{-\sigma\pi})\cos \nu\pi &= 0 \\ (e^{\sigma\pi} + e^{-\sigma\pi})\sin \nu\pi &= 0. \end{aligned}$$

(c). Based on the second equation,  $\nu = n$ ,  $n \in \mathbb{I}$ . Since  $\cos n\pi \neq 0$ , it follows that  $e^{\sigma\pi} = e^{-\sigma\pi}$ , or  $e^{2\sigma\pi} = 1$ . Hence  $\sigma = 0$ , and  $\mu = n$ ,  $n \in \mathbb{I}$ .

## Section 10.2

1. The period of the function  $\sin \alpha x$  is  $T = 2\pi/\alpha$ . Therefore the function  $\sin 5x$  has period  $T = 2\pi/5$ .

2. The period of the function  $\cos \alpha x$  is also  $T = 2\pi/\alpha$ . Therefore the function  $\cos 2\pi x$  has period  $T = 2\pi/2\pi = 1$ .

4. Based on Prob. 1, the period of the function  $\sin \pi x/L$  is  $T = 2\pi/(\pi/L) = 2L$ .

6. Let  $T > 0$  and consider the equation  $(x + T)^2 = x^2$ . It follows that  $2Tx + T^2 = 0$  and  $2x + T = 0$ . Since the latter equation is *not* an identity, the function  $x^2$  cannot be periodic with finite period.

8. The function is defined on intervals of length  $(2n + 1) - (2n - 1) = 2$ . On any two *consecutive* intervals,  $f(x)$  is identically equal to 1 on one of the intervals and alternates between 1 and  $-1$  on the other. It follows that the period is  $T = 4$ .

9. On the interval  $L < x < 2L$ , a simple *shift to the right* results in

$$f(x) = -(x - 2L) = 2L - x.$$

On the interval  $-3L < x < -2L$ , a simple *shift to the left* results in

$$f(x) = -(x + 2L) = -2L - x.$$

11. The next fundamental period *to the left* is on the interval  $-2L < x < 0$ . Hence the interval  $-L < x < 0$  is the second half of a fundamental period. A simple *shift to the left* results in

$$f(x) = L - (x + 2L) = -L - x.$$

12. First note that

$$\cos \frac{m\pi x}{L} \cos \frac{n\pi x}{L} = \frac{1}{2} \left[ \cos \frac{(m-n)\pi x}{L} + \cos \frac{(m+n)\pi x}{L} \right]$$

and

$$\cos \frac{m\pi x}{L} \sin \frac{n\pi x}{L} = \frac{1}{2} \left[ \sin \frac{(n-m)\pi x}{L} + \sin \frac{(m+n)\pi x}{L} \right].$$

It follows that

$$\begin{aligned} \int_{-L}^L \cos \frac{m\pi x}{L} \cos \frac{n\pi x}{L} dx &= \frac{1}{2} \int_{-L}^L \left[ \cos \frac{(m-n)\pi x}{L} + \cos \frac{(m+n)\pi x}{L} \right] dx \\ &= \frac{1}{2} \frac{L}{\pi} \left\{ \frac{\sin[(m-n)\pi x/L]}{m-n} + \frac{\sin[(m+n)\pi x/L]}{m+n} \right\} \Big|_{-L}^L \\ &= 0, \end{aligned}$$

as long as  $m+n$  and  $m-n$  are not zero. For the case  $m=n$ ,

$$\begin{aligned} \int_{-L}^L \left( \cos \frac{n\pi x}{L} \right)^2 dx &= \frac{1}{2} \int_{-L}^L \left[ 1 + \cos \frac{2n\pi x}{L} \right] dx \\ &= \frac{1}{2} \left\{ x + \frac{\sin(2n\pi x/L)}{2n\pi/L} \right\} \Big|_{-L}^L \\ &= L. \end{aligned}$$

Likewise,

$$\begin{aligned} \int_{-L}^L \cos \frac{m\pi x}{L} \sin \frac{n\pi x}{L} dx &= \frac{1}{2} \int_{-L}^L \left[ \sin \frac{(n-m)\pi x}{L} + \sin \frac{(m+n)\pi x}{L} \right] dx \\ &= \frac{1}{2} \frac{L}{\pi} \left\{ \frac{\cos[(n-m)\pi x/L]}{m-n} - \frac{\cos[(m+n)\pi x/L]}{m+n} \right\} \Big|_{-L}^L \\ &= 0, \end{aligned}$$

as long as  $m+n$  and  $m-n$  are not zero. For the case  $m=n$ ,

$$\begin{aligned} \int_{-L}^L \cos \frac{m\pi x}{L} \sin \frac{n\pi x}{L} dx &= \frac{1}{2} \int_{-L}^L \sin \frac{2n\pi x}{L} dx \\ &= -\frac{1}{2} \left\{ \frac{\cos(2n\pi x/L)}{2n\pi/L} \right\} \Big|_{-L}^L \\ &= 0. \end{aligned}$$

14(a). For  $L = 1$ ,

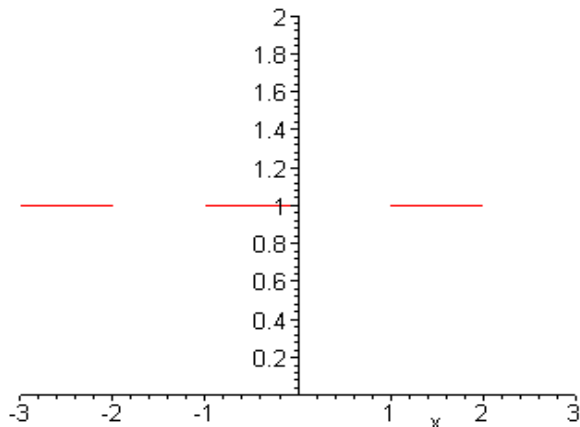

(b). The Fourier coefficients are calculated using the *Euler-Fourier* formulas:

$$\begin{aligned} a_0 &= \frac{1}{L} \int_{-L}^L f(x) dx \\ &= \frac{1}{L} \int_{-1}^1 dx \\ &= 1. \end{aligned}$$

For  $n > 0$ ,

$$\begin{aligned} a_n &= \frac{1}{L} \int_{-L}^L f(x) \cos \frac{n\pi x}{L} dx \\ &= \frac{1}{L} \int_{-1}^1 \cos \frac{n\pi x}{L} dx \\ &= 0. \end{aligned}$$

Likewise,

$$\begin{aligned} b_n &= \frac{1}{L} \int_{-L}^L f(x) \sin \frac{n\pi x}{L} dx \\ &= \frac{1}{L} \int_{-1}^1 \sin \frac{n\pi x}{L} dx \\ &= \frac{-1 + (-1)^n}{n\pi}. \end{aligned}$$

It follows that  $b_{2k} = 0$  and  $b_{2k-1} = -2/[(2k-1)\pi]$ ,  $k = 1, 2, 3, \dots$ . Therefore the Fourier series for the given function is

$$f(x) = \frac{1}{2} - \frac{2}{\pi} \sum_{k=1}^{\infty} \frac{1}{2k-1} \sin \frac{(2k-1)\pi x}{L}.$$

16(a).

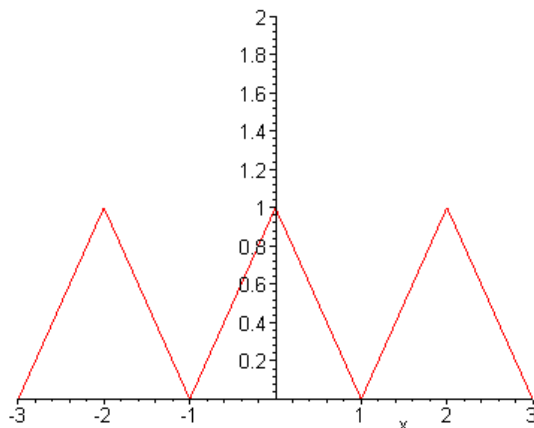

(b). The Fourier coefficients are calculated using the *Euler-Fourier* formulas:

$$\begin{aligned} a_0 &= \frac{1}{L} \int_{-L}^L f(x) dx \\ &= \int_{-1}^0 (x+1) dx + \int_0^1 (1-x) dx \\ &= 1. \end{aligned}$$

For  $n > 0$ ,

$$\begin{aligned} a_n &= \frac{1}{L} \int_{-L}^L f(x) \cos \frac{n\pi x}{L} dx \\ &= \int_{-1}^0 (x+1) \cos n\pi x dx + \int_0^1 (1-x) \cos n\pi x dx \\ &= -2 \frac{-1 + (-1)^n}{n^2 \pi^2}. \end{aligned}$$

It follows that  $a_{2k} = 0$  and  $a_{2k-1} = 4/[(2k-1)^2 \pi^2]$ ,  $k = 1, 2, 3, \dots$ . Likewise,

$$\begin{aligned} b_n &= \frac{1}{L} \int_{-L}^L f(x) \sin \frac{n\pi x}{L} dx \\ &= \int_{-1}^0 (x+1) \sin n\pi x dx + \int_0^1 (1-x) \sin n\pi x dx \\ &= 0. \end{aligned}$$

Therefore the Fourier series for the given function is

$$f(x) = \frac{1}{2} + \frac{4}{\pi^2} \sum_{k=1}^{\infty} \frac{1}{(2k-1)^2} \cos(2k-1)\pi x.$$



17(a). For  $L = 1$ ,

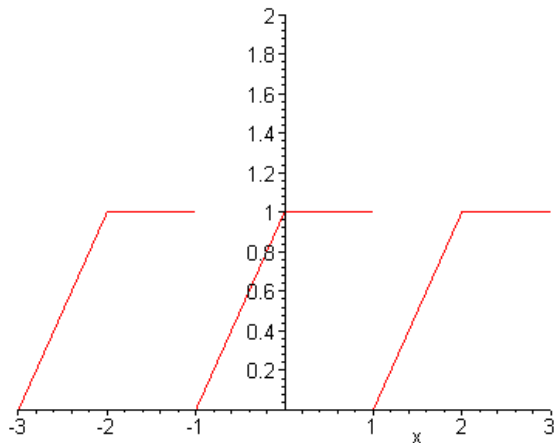

(b). The Fourier coefficients are calculated using the *Euler-Fourier* formulas:

$$\begin{aligned}
 a_0 &= \frac{1}{L} \int_{-L}^L f(x) dx \\
 &= \frac{1}{L} \int_{-L}^0 (x + L) dx + \frac{1}{L} \int_0^L L dx \\
 &= 3L/2.
 \end{aligned}$$

For  $n > 0$ ,

$$\begin{aligned}
 a_n &= \frac{1}{L} \int_{-L}^L f(x) \cos \frac{n\pi x}{L} dx \\
 &= \frac{1}{L} \int_{-L}^0 (x + L) \cos \frac{n\pi x}{L} dx + \frac{1}{L} \int_0^L L \cos \frac{n\pi x}{L} dx \\
 &= \frac{L(1 - \cos n\pi)}{n^2\pi^2}.
 \end{aligned}$$

Likewise,

$$\begin{aligned}
 b_n &= \frac{1}{L} \int_{-L}^L f(x) \sin \frac{n\pi x}{L} dx \\
 &= \frac{1}{L} \int_{-L}^0 (x + L) \sin \frac{n\pi x}{L} dx + \frac{1}{L} \int_0^L L \sin \frac{n\pi x}{L} dx \\
 &= -\frac{L \cos n\pi}{n\pi}.
 \end{aligned}$$

Note that  $\cos n\pi = (-1)^n$ . It follows that the Fourier series for the given function is

$$f(x) = \frac{3L}{4} + \frac{L}{\pi^2} \sum_{n=1}^{\infty} \left[ \frac{2}{(2n-1)^2} \cos \frac{(2n-1)\pi x}{L} - \frac{(-1)^n \pi}{n} \sin \frac{n\pi x}{L} \right].$$

18(a).

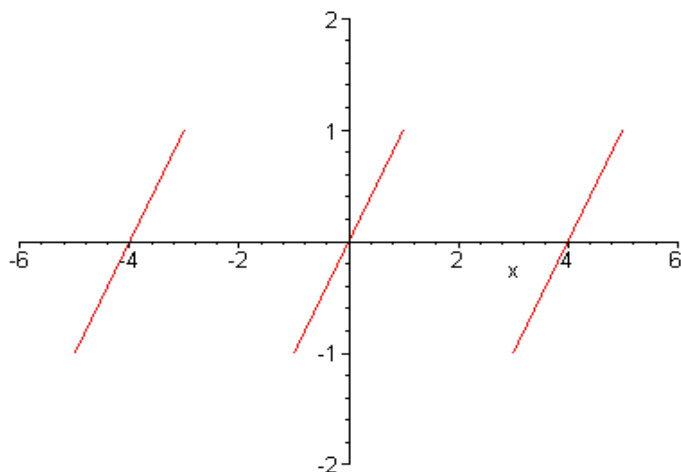

(b). The Fourier coefficients are calculated using the *Euler-Fourier* formulas:

$$\begin{aligned} a_0 &= \frac{1}{L} \int_{-L}^L f(x) dx \\ &= \frac{1}{2} \int_{-1}^1 x dx \\ &= 0. \end{aligned}$$

For  $n > 0$ ,

$$\begin{aligned} a_n &= \frac{1}{L} \int_{-L}^L f(x) \cos \frac{n\pi x}{L} dx \\ &= \frac{1}{2} \int_{-1}^1 x \cos \frac{n\pi x}{L} dx \\ &= 0. \end{aligned}$$

Likewise,

$$\begin{aligned} b_n &= \frac{1}{L} \int_{-L}^L f(x) \sin \frac{n\pi x}{L} dx \\ &= \frac{1}{2} \int_{-1}^1 x \sin \frac{n\pi x}{L} dx \\ &= \frac{2}{n^2 \pi^2} \left( 2 \sin \frac{n\pi}{2} - n\pi \cos \frac{n\pi}{2} \right). \end{aligned}$$

Therefore the Fourier series for the given function is

$$f(x) = \sum_{n=1}^{\infty} \left[ \frac{4}{n^2\pi^2} \sin \frac{n\pi}{2} - \frac{2}{n\pi} \cos \frac{n\pi}{2} \right] \sin \frac{n\pi x}{2}.$$

19(a).

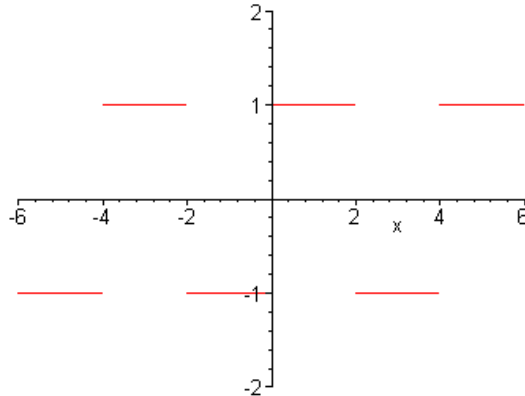

(b). The Fourier *cosine* coefficients are given by

$$\begin{aligned} a_n &= \frac{1}{L} \int_{-L}^L f(x) \cos \frac{n\pi x}{L} dx \\ &= \frac{1}{2} \int_{-2}^0 -\cos \frac{n\pi x}{2} dx + \frac{1}{2} \int_0^2 \cos \frac{n\pi x}{2} dx \\ &= 0. \end{aligned}$$

The Fourier *sine* coefficients are given by

$$\begin{aligned} b_n &= \frac{1}{L} \int_{-L}^L f(x) \sin \frac{n\pi x}{L} dx \\ &= \frac{1}{2} \int_{-2}^0 -\sin \frac{n\pi x}{2} dx + \frac{1}{2} \int_0^2 \sin \frac{n\pi x}{2} dx \\ &= 2 \frac{1 - \cos n\pi}{n\pi}. \end{aligned}$$

Therefore the Fourier series for the given function is

$$f(x) = \frac{4}{\pi} \sum_{n=1}^{\infty} \frac{1}{2n-1} \sin \frac{(2n-1)\pi x}{2}.$$

(c).

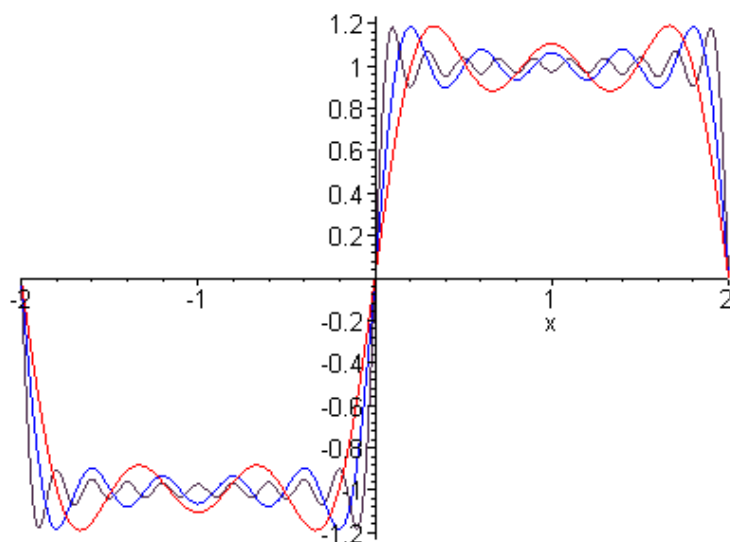

20(a).

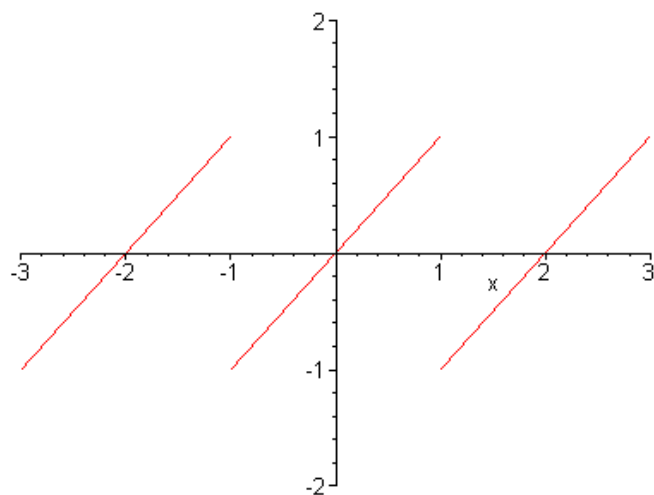
(b). The Fourier *sine* coefficients are given by

$$\begin{aligned} a_n &= \frac{1}{L} \int_{-L}^L f(x) \cos \frac{n\pi x}{L} dx \\ &= \int_{-1}^1 x \cos n\pi x dx \\ &= 0. \end{aligned}$$

The Fourier *sine* coefficients are given by

$$\begin{aligned}
 b_n &= \frac{1}{L} \int_{-L}^L f(x) \sin \frac{n\pi x}{L} dx \\
 &= \int_{-1}^1 x \sin n\pi x dx \\
 &= -2 \frac{\cos n\pi}{n\pi}.
 \end{aligned}$$

Therefore the Fourier series for the given function is

$$f(x) = -\frac{2}{\pi} \sum_{n=1}^{\infty} \frac{(-1)^n}{n} \sin n\pi x.$$

(c).

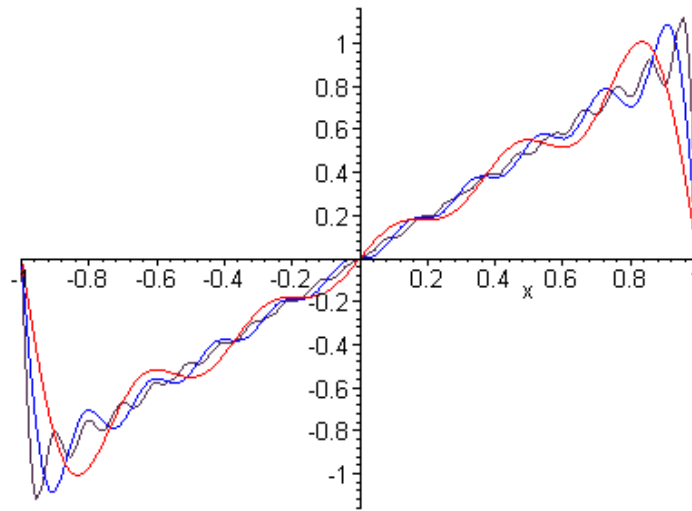

22(a).

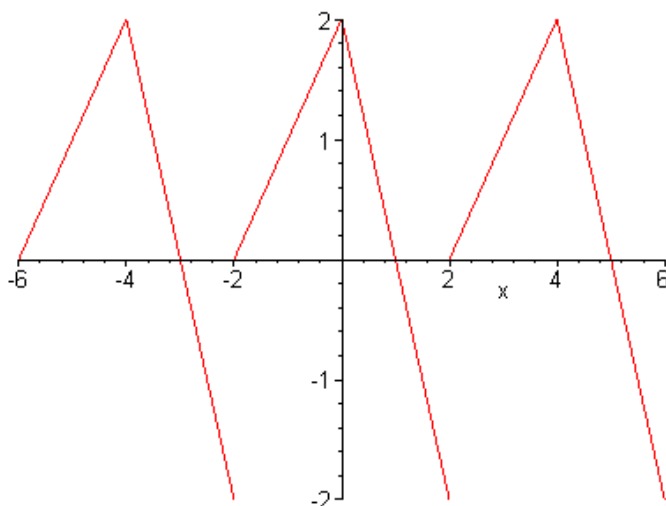

(b). The Fourier *cosine* coefficients are given by

$$\begin{aligned} a_0 &= \frac{1}{L} \int_{-L}^L f(x) dx \\ &= \frac{1}{2} \int_{-2}^0 (x+2) dx + \frac{1}{2} \int_0^2 (2-2x) dx \\ &= 1, \end{aligned}$$

and for  $n > 0$ ,

$$\begin{aligned} a_n &= \frac{1}{L} \int_{-L}^L f(x) \cos \frac{n\pi x}{L} dx \\ &= \frac{1}{2} \int_{-2}^0 (x+2) \cos \frac{n\pi x}{2} dx + \frac{1}{2} \int_0^2 (2-2x) \cos \frac{n\pi x}{2} dx \\ &= 6 \frac{(1 - \cos n\pi)}{n^2 \pi^2}. \end{aligned}$$

The Fourier *sine* coefficients are given by

$$\begin{aligned} b_n &= \frac{1}{L} \int_{-L}^L f(x) \sin \frac{n\pi x}{L} dx \\ &= \frac{1}{2} \int_{-2}^0 (x+2) \sin \frac{n\pi x}{2} dx + \frac{1}{2} \int_0^2 (2-2x) \sin \frac{n\pi x}{2} dx \\ &= 2 \frac{\cos n\pi}{n\pi}. \end{aligned}$$

Therefore the Fourier series for the given function is

$$f(x) = \frac{1}{2} + \frac{12}{\pi^2} \sum_{n=1}^{\infty} \frac{1}{(2n-1)^2} \cos \frac{(2n-1)\pi x}{2} + \frac{2}{\pi} \sum_{n=1}^{\infty} \frac{(-1)^n}{n} \sin \frac{n\pi x}{2}.$$

(c).

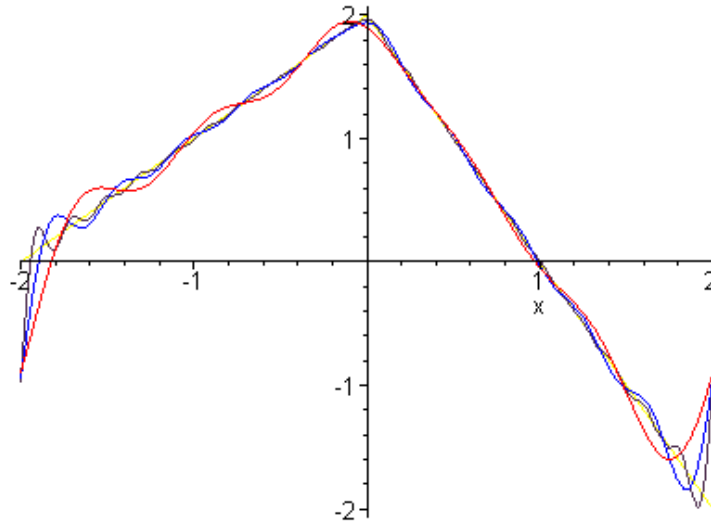

23(a).

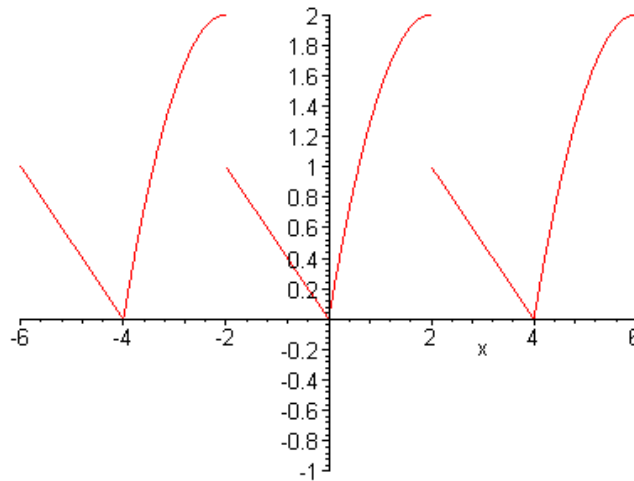

(b). The Fourier *cosine* coefficients are given by

$$\begin{aligned}
 a_0 &= \frac{1}{L} \int_{-L}^L f(x) dx \\
 &= \frac{1}{2} \int_{-2}^0 \left(-\frac{x}{2}\right) dx + \frac{1}{2} \int_0^2 \left(2x - \frac{1}{2}x^2\right) dx \\
 &= 11/6,
 \end{aligned}$$

and for  $n > 0$ ,

$$\begin{aligned}
 a_n &= \frac{1}{L} \int_{-L}^L f(x) \cos \frac{n\pi x}{L} dx \\
 &= \frac{1}{2} \int_{-2}^0 \left(-\frac{x}{2}\right) \cos \frac{n\pi x}{2} dx + \frac{1}{2} \int_0^2 \left(2x - \frac{1}{2}x^2\right) \cos \frac{n\pi x}{2} dx \\
 &= -\frac{(5 - \cos n\pi)}{n^2\pi^2}.
 \end{aligned}$$

The Fourier *sine* coefficients are given by

$$\begin{aligned}
 b_n &= \frac{1}{L} \int_{-L}^L f(x) \sin \frac{n\pi x}{L} dx \\
 &= \frac{1}{2} \int_{-2}^0 \left(-\frac{x}{2}\right) \sin \frac{n\pi x}{2} dx + \frac{1}{2} \int_0^2 \left(2x - \frac{1}{2}x^2\right) \sin \frac{n\pi x}{2} dx \\
 &= \frac{4 - (4 + n^2\pi^2)\cos n\pi}{n^3\pi^3}.
 \end{aligned}$$

Therefore the Fourier series for the given function is

$$\begin{aligned}
 f(x) &= \frac{11}{12} + \frac{1}{\pi^2} \sum_{n=1}^{\infty} \frac{[(-1)^n - 5]}{n^2} \cos \frac{n\pi x}{2} + \\
 &\quad + \frac{1}{\pi^3} \sum_{n=1}^{\infty} \frac{[4 - (4 + n^2\pi^2)(-1)^n]}{n^3} \sin \frac{n\pi x}{2}.
 \end{aligned}$$



(c).

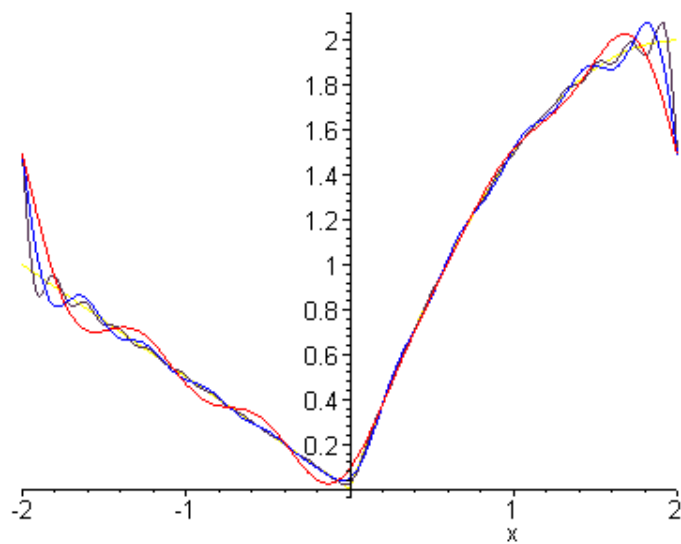

24(a).

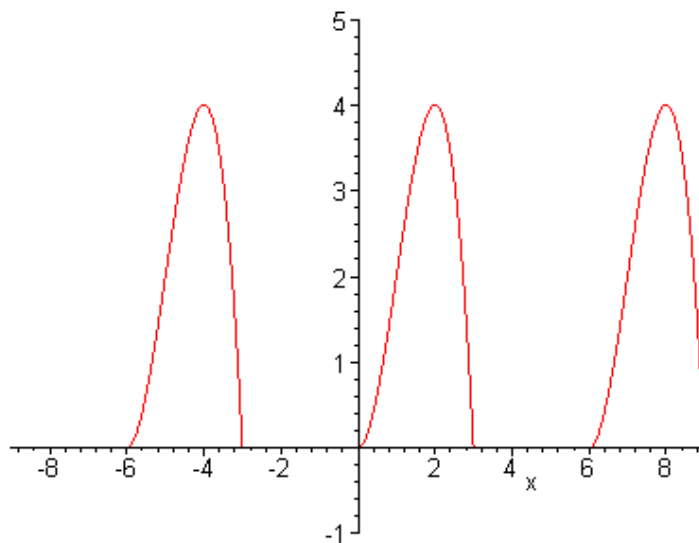
(b). The Fourier *cosine* coefficients are given by

$$\begin{aligned} a_0 &= \frac{1}{L} \int_{-L}^L f(x) dx \\ &= \frac{1}{3} \int_0^3 x^2(3-x) dx \\ &= 9/4, \end{aligned}$$

and for  $n > 0$ ,

$$\begin{aligned}
 a_n &= \frac{1}{L} \int_{-L}^L f(x) \cos \frac{n\pi x}{L} dx \\
 &= \frac{1}{3} \int_0^3 x^2(3-x) \cos \frac{n\pi x}{3} dx \\
 &= -27 \frac{(6 - 6 \cos n\pi + n^2 \pi^2 \cos n\pi)}{n^4 \pi^4}.
 \end{aligned}$$

The Fourier *sine* coefficients are given by

$$\begin{aligned}
 b_n &= \frac{1}{L} \int_{-L}^L f(x) \sin \frac{n\pi x}{L} dx \\
 &= \frac{1}{3} \int_0^3 x^2(3-x) \sin \frac{n\pi x}{3} dx \\
 &= -54 \frac{1 + 2 \cos n\pi}{n^3 \pi^3}.
 \end{aligned}$$

Therefore the Fourier series for the given function is

$$\begin{aligned}
 f(x) &= \frac{9}{8} - 27 \sum_{n=1}^{\infty} \left[ \frac{6[1 - (-1)^n]}{n^4 \pi^4} + \frac{(-1)^n}{n^2 \pi^2} \right] \cos \frac{n\pi x}{3} - \\
 &\quad - \frac{54}{\pi^3} \sum_{n=1}^{\infty} \frac{[1 + 2(-1)^n]}{n^3} \sin \frac{n\pi x}{3}.
 \end{aligned}$$

(c).

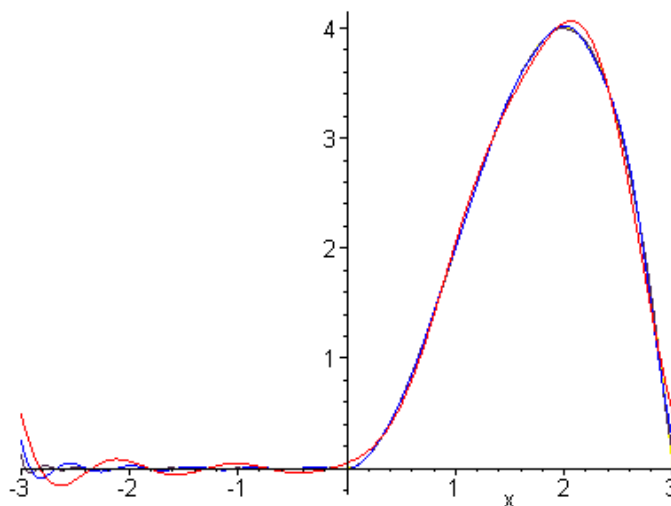

26.

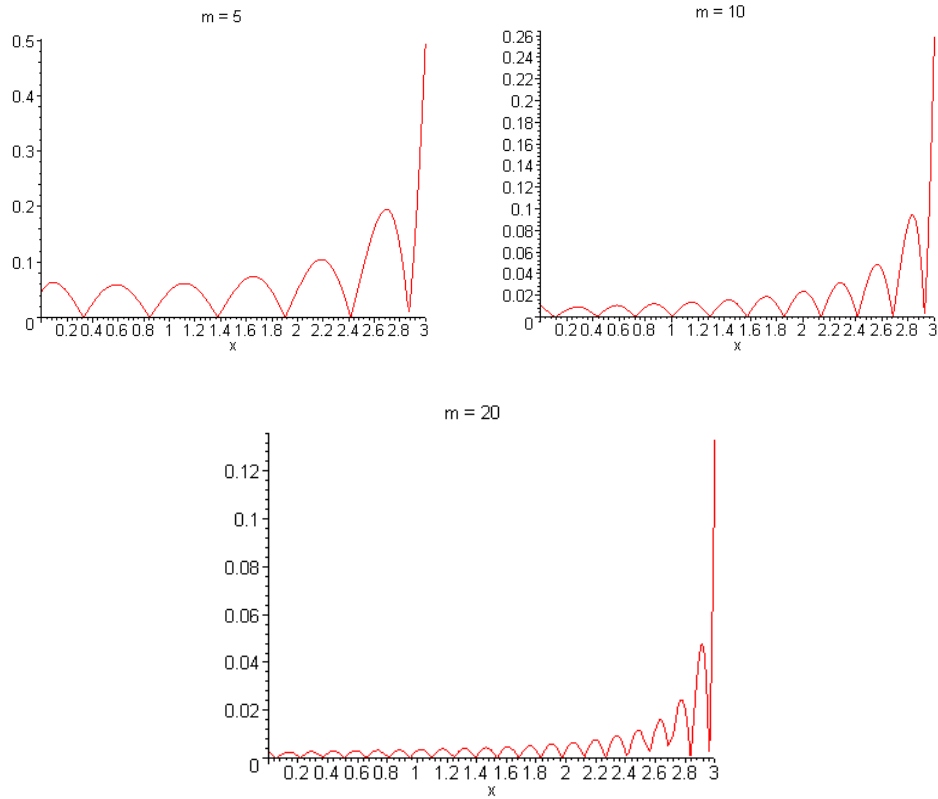

It is evident that  $|e_m(x)|$  is greatest at  $x = \pm 3$ . Increasing the number of terms in the partials sums, we find that if  $m \geq 27$ , then  $|e_m(x)| \leq 0.1$ , for all  $x \in [-3, 3]$ .

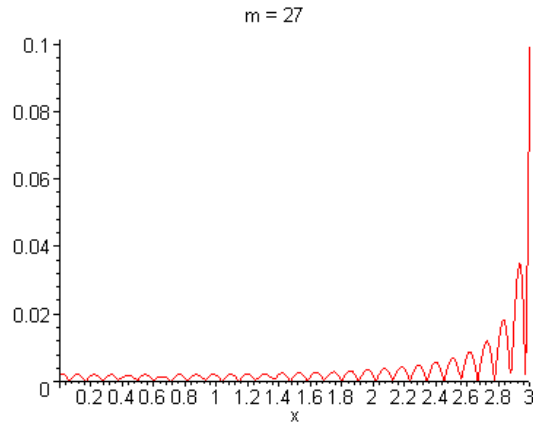

Graphing the partial sum  $s_{27}(x)$ , the convergence is as predicted:

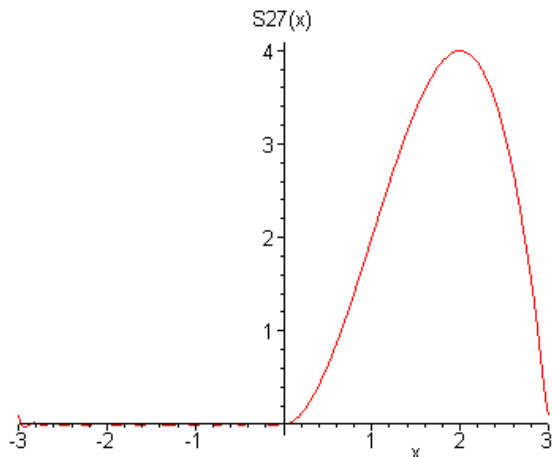

28. Let  $x = T + a$ , for some  $a \in [0, T]$ . First note that for any value of  $h$ ,

$$\begin{aligned} f(x+h) - f(x) &= f(T+a+h) - f(T+a) \\ &= f(a+h) - f(a). \end{aligned}$$

Since  $f$  is differentiable,

$$\begin{aligned} f'(x) &= \lim_{h \rightarrow 0} \frac{f(x+h) - f(x)}{h} \\ &= \lim_{h \rightarrow 0} \frac{f(a+h) - f(a)}{h} \\ &= f'(a). \end{aligned}$$

That is,  $f'(a+T) = f'(a)$ . By induction, it follows that  $f'(a+T) = f'(a)$  for every value of  $a$ .

On the other hand, if  $f(x) = 1 + \cos x$ , then the function

$$\begin{aligned} F(x) &= \int_0^x [1 + \cos t] dt \\ &= x + \sin x \end{aligned}$$

is *not* periodic, unless its definition is restricted to a specific interval.

29(a). Based on the hypothesis, the vectors  $\mathbf{v}_1$ ,  $\mathbf{v}_2$  and  $\mathbf{v}_3$  are a basis for  $\mathbb{R}^3$ . Given any vector  $\mathbf{u} \in \mathbb{R}^3$ , it can be expressed as a linear combination  $\mathbf{u} = a_1\mathbf{v}_1 + a_2\mathbf{v}_2 + a_3\mathbf{v}_3$ . Taking the inner product of both sides of this equation with  $\mathbf{v}_i$ , we have

$$\begin{aligned} \mathbf{u} \cdot \mathbf{v}_i &= (a_1\mathbf{v}_1 + a_2\mathbf{v}_2 + a_3\mathbf{v}_3) \cdot \mathbf{v}_i \\ &= a_i \mathbf{v}_i \cdot \mathbf{v}_i, \end{aligned}$$

since the basis vectors are mutually orthogonal. Hence

$$a_i = \frac{\mathbf{u} \cdot \mathbf{v}_i}{\mathbf{v}_i \cdot \mathbf{v}_i}, \quad i = 1, 2, 3.$$

Recall that  $\mathbf{u} \cdot \mathbf{v}_i = u v_i \cos \theta$ , in which  $\theta$  is the angle between  $\mathbf{u}$  and  $\mathbf{v}_i$ . Therefore

$$a_i = \frac{u \cos \theta}{v_i}.$$

Here  $u \cos \theta$  is interpreted as the magnitude of the projection of  $\mathbf{u}$  in the direction of  $\mathbf{v}_i$ .

(b). Assuming that a Fourier series converges to a periodic function,  $f(x)$ ,

$$f(x) = \frac{a_0}{2} \phi_0(x) + \sum_{m=1}^{\infty} a_m \phi_m(x) + \sum_{m=1}^{\infty} b_m \psi_m(x).$$

Taking the inner product, defined by

$$(u, v) = \int_{-L}^L u(x)v(x)dx,$$

of both sides of the series expansion with the specified trigonometric functions, we have

$$(f, \phi_n) = \frac{a_0}{2} (\phi_0, \phi_n) + \sum_{m=1}^{\infty} a_m (\phi_m, \phi_n) + \sum_{m=1}^{\infty} b_m (\psi_m, \phi_n)$$

for  $n = 0, 1, 2, \dots$ .

(c). It also follows that

$$(f, \psi_n) = \frac{a_0}{2} (\phi_0, \psi_n) + \sum_{m=1}^{\infty} a_m (\phi_m, \psi_n) + \sum_{m=1}^{\infty} b_m (\psi_m, \psi_n)$$

for  $n = 1, 2, \dots$ . Based on the orthogonality conditions,

$$(\phi_m, \phi_n) = L \delta_{mn}, \quad (\psi_m, \psi_n) = L \delta_{mn},$$

and  $(\psi_m, \phi_n) = L \delta_{mn}$ . Note that  $(\phi_0, \phi_0) = 2L$ . Therefore

$$a_0 = \frac{2(f, \phi_0)}{(\phi_0, \phi_0)} = \frac{1}{L} \int_{-L}^L f(x) \phi_0(x) dx$$

and

$$a_n = \frac{(f, \phi_n)}{(\phi_n, \phi_n)} = \frac{1}{L} \int_{-L}^L f(x) \phi_n(x) dx, \quad n = 1, 2, \dots$$

Likewise,

$$b_n = \frac{(f, \psi_n)}{(\psi_n, \psi_n)} = \frac{1}{L} \int_{-L}^L f(x) \psi_n(x) dx, \quad n = 1, 2, \dots$$

## Section 10.3

1(a). The given function is assumed to be periodic with  $2L = 2$ . The Fourier *cosine* coefficients are given by

$$\begin{aligned} a_0 &= \frac{1}{L} \int_{-L}^L f(x) dx \\ &= \int_{-1}^0 (-1) dx + \int_0^1 (1) dx \\ &= 0, \end{aligned}$$

and for  $n > 0$ ,

$$\begin{aligned} a_n &= \frac{1}{L} \int_{-L}^L f(x) \cos \frac{n\pi x}{L} dx \\ &= - \int_{-1}^0 \cos n\pi x dx + \int_0^1 \cos n\pi x dx \\ &= 0. \end{aligned}$$

The Fourier *sine* coefficients are given by

$$\begin{aligned} b_n &= \frac{1}{L} \int_{-L}^L f(x) \sin \frac{n\pi x}{L} dx \\ &= - \int_{-1}^0 \sin n\pi x dx + \int_0^1 \sin n\pi x dx \\ &= 2 \frac{1 - \cos n\pi}{n\pi}. \end{aligned}$$

Therefore the Fourier series for the specified function is

$$f(x) = \frac{4}{\pi} \sum_{n=1}^{\infty} \frac{1}{2n-1} \sin (2n-1)\pi x.$$

(b).

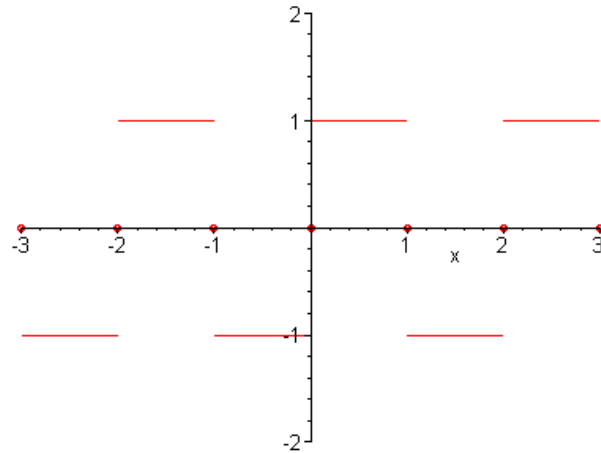

The function is piecewise continuous on each finite interval. The points of discontinuity are at *integer* values of  $x$ . At these points, the series converges to

$$|f(x -) + f(x +)| = 0.$$

3(a). The given function is assumed to be periodic with  $T = 2L$ . The Fourier *cosine* coefficients are given by

$$\begin{aligned} a_0 &= \frac{1}{L} \int_{-L}^L f(x) dx \\ &= \frac{1}{L} \int_{-L}^0 (L+x) dx + \frac{1}{L} \int_0^L (L-x) dx \\ &= L, \end{aligned}$$

and for  $n > 0$ ,

$$\begin{aligned} a_n &= \frac{1}{L} \int_{-L}^L f(x) \cos \frac{n\pi x}{L} dx \\ &= \frac{1}{L} \int_{-L}^0 (L+x) \cos \frac{n\pi x}{L} dx + \frac{1}{L} \int_0^L (L-x) \cos \frac{n\pi x}{L} dx \\ &= 2L \frac{1 - \cos n\pi}{n^2 \pi^2}. \end{aligned}$$

The Fourier *sine* coefficients are given by

$$\begin{aligned} b_n &= \frac{1}{L} \int_{-L}^L f(x) \sin \frac{n\pi x}{L} dx \\ &= \frac{1}{L} \int_{-L}^0 (L+x) \sin \frac{n\pi x}{L} dx + \frac{1}{L} \int_0^L (L-x) \sin \frac{n\pi x}{L} dx \\ &= 0. \end{aligned}$$



Therefore the Fourier series of the specified function is

$$f(x) = \frac{L}{2} + \frac{4L}{\pi^2} \sum_{n=1}^{\infty} \frac{1}{(2n-1)^2} \cos \frac{(2n-1)\pi x}{L}.$$

(b). For  $L = 1$ ,

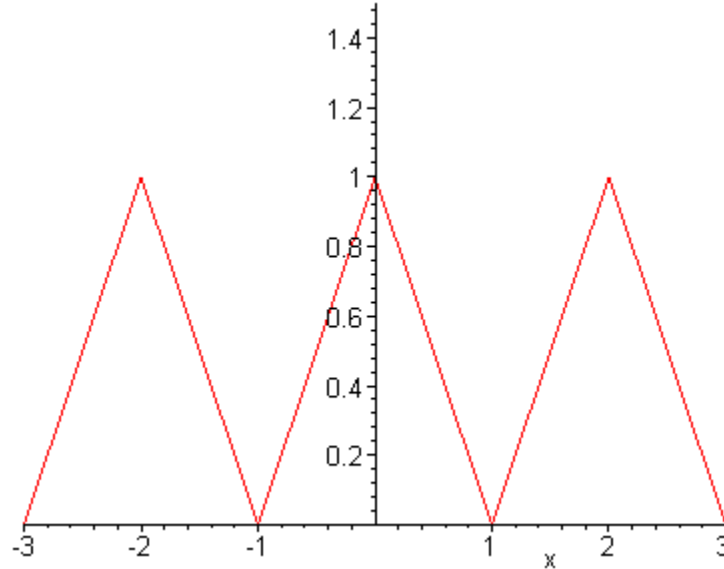

Note that  $f(x)$  is *continuous*. Based on Theorem 10.3.1, the series converges to the continuous function  $f(x)$ .

5(a). The given function is assumed to be periodic with  $2L = 2\pi$ . The Fourier *cosine* coefficients are given by

$$\begin{aligned} a_0 &= \frac{1}{L} \int_{-L}^L f(x) dx \\ &= \frac{1}{\pi} \int_{-\pi/2}^{\pi/2} (1) dx \\ &= 1, \end{aligned}$$

and for  $n > 0$ ,

$$\begin{aligned} a_n &= \frac{1}{L} \int_{-L}^L f(x) \cos \frac{n\pi x}{L} dx \\ &= \frac{1}{\pi} \int_{-\pi/2}^{\pi/2} (1) \cos nx dx \\ &= \frac{2}{n\pi} \sin \left( \frac{n\pi}{2} \right). \end{aligned}$$

The Fourier *sine* coefficients are given by

$$\begin{aligned}
 b_n &= \frac{1}{L} \int_{-L}^L f(x) \sin \frac{n\pi x}{L} dx \\
 &= \frac{1}{\pi} \int_{-\pi/2}^{\pi/2} (1) \sin nx dx \\
 &= 0.
 \end{aligned}$$

Observe that

$$\sin\left(\frac{n\pi}{2}\right) = \begin{cases} 0, & n = 2k \\ (-1)^{k+1}, & n = 2k - 1 \end{cases}, k = 1, 2, \dots$$

Therefore the Fourier series of the specified function is

$$f(x) = \frac{1}{2} - \frac{2}{\pi} \sum_{n=1}^{\infty} \frac{(-1)^n}{2n-1} \cos(2n-1)x.$$

(b).

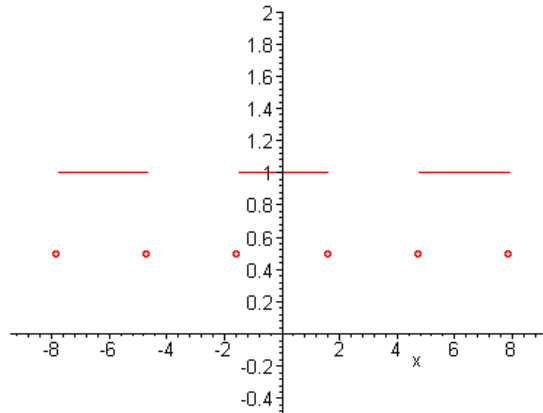

The given function is piecewise continuous, with discontinuities at *odd* multiples of  $\pi/2$ . At  $x_d = (2k - 1)\pi/2, k = 0, 1, 2, \dots$ , the series converges to

$$|f(x_d -) + f(x_d +)| = 1/2.$$

6(a). The given function is assumed to be periodic with  $2L = 2$ . The Fourier *cosine* coefficients are given by

$$\begin{aligned}
 a_0 &= \frac{1}{L} \int_{-L}^L f(x) dx \\
 &= \int_0^1 x^2 dx \\
 &= 1/3,
 \end{aligned}$$

and for  $n > 0$ ,

$$\begin{aligned}
 a_n &= \frac{1}{L} \int_{-L}^L f(x) \cos \frac{n\pi x}{L} dx \\
 &= \int_0^1 x^2 \cos n\pi x dx \\
 &= \frac{2 \cos n\pi}{n^2 \pi^2}.
 \end{aligned}$$

The Fourier *sine* coefficients are given by

$$\begin{aligned}
 b_n &= \frac{1}{L} \int_{-L}^L f(x) \sin \frac{n\pi x}{L} dx \\
 &= \int_0^1 x^2 \sin n\pi x dx \\
 &= -\frac{2 - 2 \cos n\pi + n^2 \pi^2 \cos n\pi}{n^3 \pi^3}.
 \end{aligned}$$

Therefore the Fourier series for the specified function is

$$\begin{aligned}
 f(x) &= \frac{1}{6} + \frac{2}{\pi^2} \sum_{n=1}^{\infty} \frac{(-1)^n}{n^2} \cos n\pi x - \\
 &\quad - \sum_{n=1}^{\infty} \left[ \frac{2[1 - (-1)^n]}{n^3 \pi^3} + \frac{(-1)^n}{n\pi} \right] \sin n\pi x.
 \end{aligned}$$

(b).

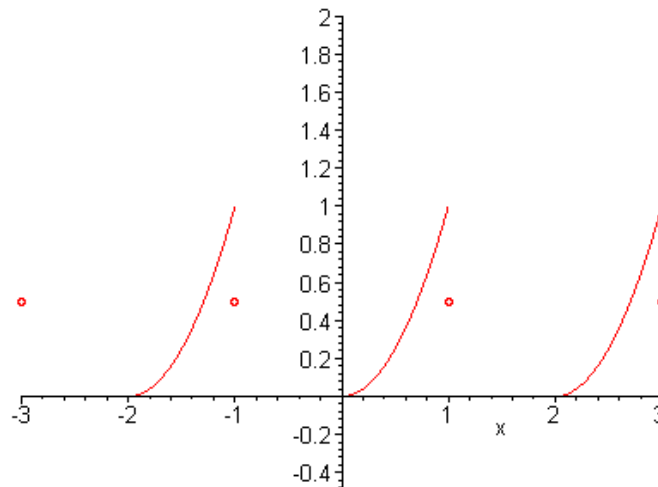

The given function is piecewise continuous, with discontinuities at the *odd* integers.

At  $x_d = 2k - 1, k = 0, 1, 2, \dots$ , the series converges to

$$|f(x_d -) + f(x_d +)| = 1/2.$$

8(a). As shown in Problem 16 of Section 10.2,

$$f(x) = \frac{1}{2} + \frac{4}{\pi^2} \sum_{n=1}^{\infty} \frac{1}{(2n-1)^2} \cos(2n-1)\pi x.$$

(b).

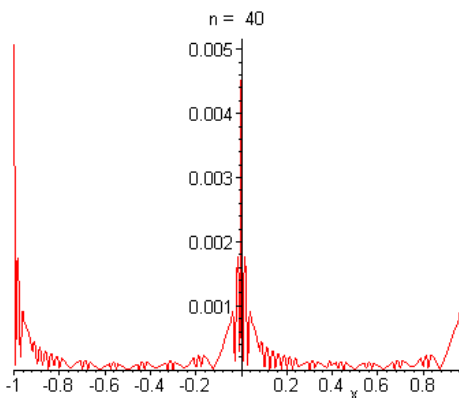
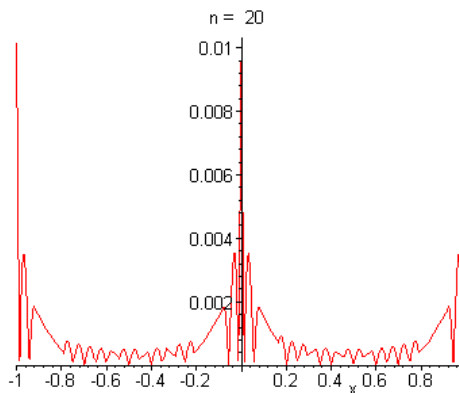
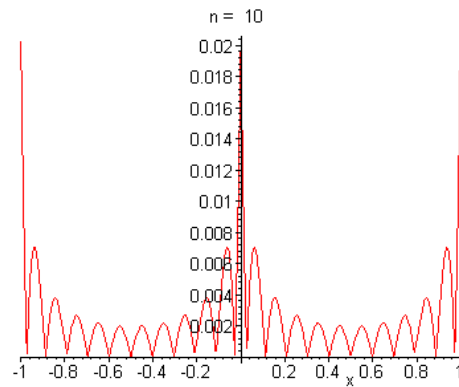

(c).

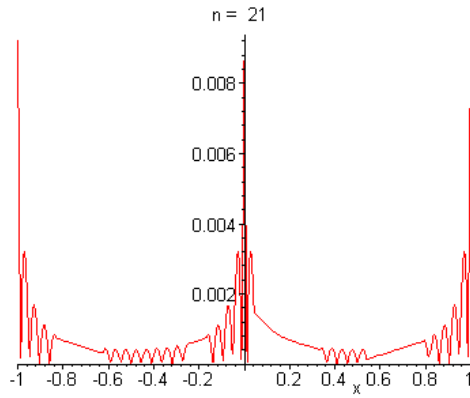

9(a). As shown in Problem 20 of Section 10.2,

$$f(x) = -\frac{2}{\pi} \sum_{n=1}^{\infty} \frac{(-1)^n}{n} \sin n\pi x.$$

(b).

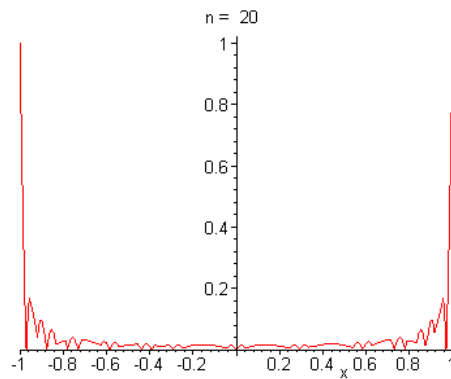
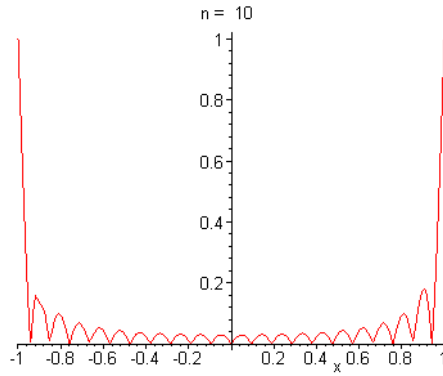

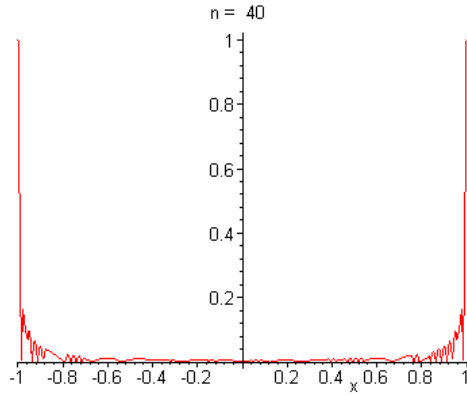

(c). The given function is discontinuous at  $x = \pm 1$ . At these points, the series will converge to a value of *zero*. The error can never be made arbitrarily small.

10(a). As shown in Problem 22 of Section 10.2,

$$f(x) = \frac{1}{2} + \frac{12}{\pi^2} \sum_{n=1}^{\infty} \frac{1}{(2n-1)^2} \cos \frac{(2n-1)\pi x}{2} + \frac{2}{\pi} \sum_{n=1}^{\infty} \frac{(-1)^n}{n} \sin \frac{n\pi x}{2}.$$

(b).

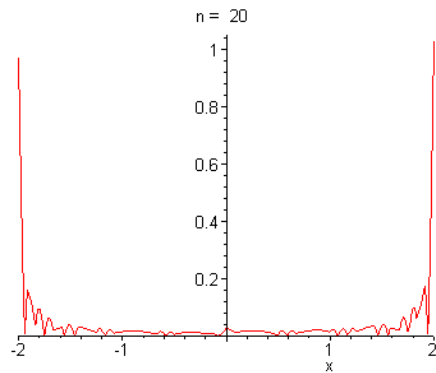
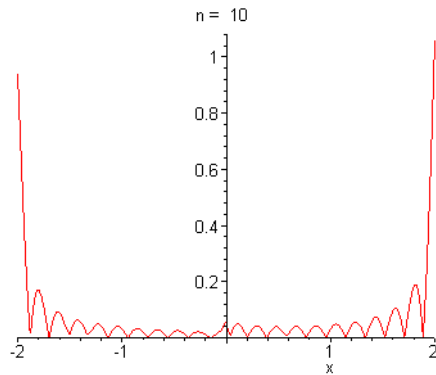

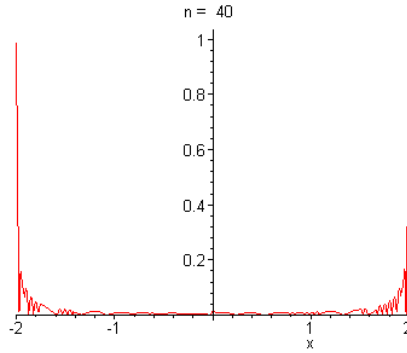

(c). The given function is discontinuous at  $x = \pm 2$ . At these points, the series will converge to a value of  $\frac{1}{2}$ . The error can never be made arbitrarily small.

11(a). As shown in Problem 6, above,

$$f(x) = \frac{1}{6} + \frac{2}{\pi^2} \sum_{n=1}^{\infty} \frac{(-1)^n}{n^2} \cos n\pi x - \sum_{n=1}^{\infty} \left[ \frac{2[1 - (-1)^n]}{n^3 \pi^3} + \frac{(-1)^n}{n\pi} \right] \sin n\pi x.$$

(b).

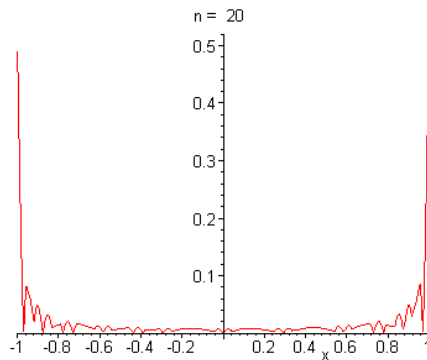
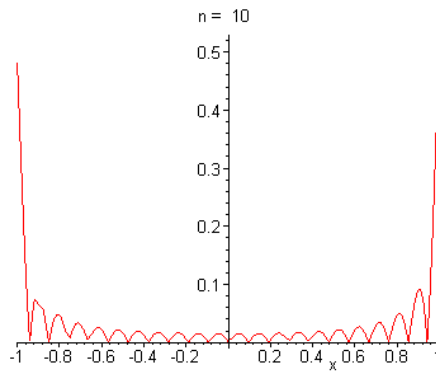

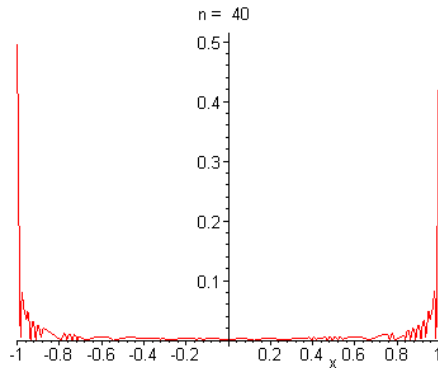

(c). The given function is piecewise continuous, with discontinuities at the *odd* integers. At  $x_d = 2k - 1, k = 0, 1, 2, \dots$ , the series converges to

$$|f(x_d -) + f(x_d +)| = 1/2.$$

At these points the error can never be made arbitrarily small.

13. The solution of the *homogenous* differential equation is

$$y_c(t) = c_1 \cos \omega t + c_2 \sin \omega t.$$

Given that  $\omega^2 \neq n^2$ , we can use the *method of undetermined coefficients* to find a particular solution

$$Y(t) = \frac{1}{\omega^2 - n^2} \sin nt.$$

Hence the general solution of the ODE is

$$y(t) = c_1 \cos \omega t + c_2 \sin \omega t + \frac{1}{\omega^2 - n^2} \sin nt.$$

Imposing the initial conditions, we obtain the equations

$$\begin{aligned} c_1 &= 0 \\ \omega c_2 + \frac{n}{\omega^2 - n^2} &= 0. \end{aligned}$$

It follows that  $c_2 = -n/[\omega(\omega^2 - n^2)]$ . The solution of the IVP is

$$y(t) = \frac{1}{\omega^2 - n^2} \sin nt - \frac{n}{\omega(\omega^2 - n^2)} \sin \omega t.$$

If  $\omega^2 = n^2$ , then the forcing function is also one of the fundamental solutions of the ODE.

The method of undetermined coefficients may still be used, with a more elaborate trial solution. Using the *method of variation of parameters*, we obtain



$$\begin{aligned}
 Y(t) &= -\cos nt \int \frac{\sin^2 nt}{n} dt + \sin nt \int \frac{\cos nt \sin nt}{n} dt \\
 &= \frac{\sin nt - nt \cos nt}{2n^2}.
 \end{aligned}$$

In this case, the general solution is

$$y(t) = c_1 \cos nt + c_2 \sin nt - \frac{t}{2n} \cos nt.$$

Invoking the initial conditions, we obtain  $c_1 = 0$  and  $c_2 = 1/2n^2$ . Therefore the solution of the IVP is

$$y(t) = \frac{1}{2n^2} \sin nt - \frac{t}{2n} \cos nt.$$

16. Note that the function  $f(t)$  and the function given in Problem 8 have the same Fourier series. Therefore

$$f(t) = \frac{1}{2} + \frac{4}{\pi^2} \sum_{n=1}^{\infty} \frac{1}{(2n-1)^2} \cos(2n-1)\pi t.$$

The solution of the homogeneous problem is

$$y_c(t) = c_1 \cos \omega t + c_2 \sin \omega t.$$

Using the method of undetermined coefficients, we assume a particular solution of the form

$$Y(t) = A_0 + \sum_{n=1}^{\infty} A_n \cos n\pi t.$$

Substitution into the ODE and equating like terms results in  $A_0 = 1/2\omega^2$  and

$$A_n = \frac{a_n}{\omega^2 - n^2\pi^2}.$$

It follows that the general solution is

$$y(t) = c_1 \cos \omega t + c_2 \sin \omega t + \frac{1}{2\omega^2} + \frac{4}{\pi^2} \sum_{n=1}^{\infty} \frac{\cos(2n-1)\pi t}{(2n-1)^2 [\omega^2 - (2n-1)^2\pi^2]}.$$

Setting  $y(0) = 1$ , we find that

$$c_1 = 1 - \frac{1}{2\omega^2} - \frac{4}{\pi^2} \sum_{n=1}^{\infty} \frac{\cos(2n-1)\pi t}{(2n-1)^2 [\omega^2 - (2n-1)^2\pi^2]}.$$

Invoking the initial condition  $y'(0) = 0$ , we obtain  $c_2 = 0$ . Hence the solution of the initial value problem is

$$y(t) = \cos \omega t - \frac{1}{2\omega^2} \cos \omega t + \frac{1}{2\omega^2} + \frac{4}{\pi^2} \sum_{n=1}^{\infty} \frac{\cos(2n-1)\pi t - \cos \omega t}{(2n-1)^2 [\omega^2 - (2n-1)^2 \pi^2]}.$$

17. Let

$$f(x) = \frac{a_0}{2} + \sum_{n=1}^{\infty} \left[ a_n \cos \frac{n\pi x}{L} + b_n \sin \frac{n\pi x}{L} \right].$$

Squaring both sides of the equation, we *formally* have

$$\begin{aligned} |f(x)|^2 &= \frac{a_0^2}{4} + \sum_{n=1}^{\infty} \left[ a_n^2 \cos^2 \frac{n\pi x}{L} + b_n^2 \sin^2 \frac{n\pi x}{L} \right] + a_0 \sum_{n=1}^{\infty} \left[ a_n \cos \frac{n\pi x}{L} + b_n \sin \frac{n\pi x}{L} \right] + \\ &+ \sum_{m \neq n} \left[ c_{mn} \cos \frac{m\pi x}{L} \sin \frac{n\pi x}{L} \right]. \end{aligned}$$

Integrating both sides of the last equation, and using the *orthogonality conditions*,

$$\begin{aligned} \int_{-L}^L |f(x)|^2 dx &= \int_{-L}^L \frac{a_0^2}{4} dx + \sum_{n=1}^{\infty} \left[ \int_{-L}^L a_n^2 \cos^2 \frac{n\pi x}{L} dx + \int_{-L}^L b_n^2 \sin^2 \frac{n\pi x}{L} dx \right] \\ &= \frac{a_0^2}{2} L + \sum_{n=1}^{\infty} [a_n^2 L + b_n^2 L]. \end{aligned}$$

Therefore,

$$\frac{1}{L} \int_{-L}^L |f(x)|^2 dx = \frac{a_0^2}{2} + \sum_{n=1}^{\infty} (a_n^2 + b_n^2).$$

19(a). As shown in the Example, the Fourier series of the function

$$f(x) = \begin{cases} 0, & -L < x < 0 \\ L, & 0 < x < L, \end{cases}$$

is given by

$$f(x) = \frac{L}{2} + \frac{2L}{\pi} \sum_{n=1}^{\infty} \frac{1}{2n-1} \sin \frac{(2n-1)\pi x}{L}.$$

Setting  $L = 1$ ,

$$f(x) = \frac{1}{2} + \frac{2}{\pi} \sum_{n=1}^{\infty} \frac{1}{2n-1} \sin(2n-1)\pi x.$$

It follows that

$$\sum_{n=1}^{\infty} \frac{1}{2n-1} \sin(2n-1)\pi x = \frac{\pi}{2} \left[ f(x) - \frac{1}{2} \right]. \quad (ii)$$

(b). Given that

$$g(x) = \sum_{n=1}^{\infty} \frac{2n-1}{1+(2n-1)^2} \sin(2n-1)\pi x, \quad (i)$$

and subtracting Eq.(ii) from Eq.(i), we find that

$$\begin{aligned} g(x) - \frac{\pi}{2} \left[ f(x) - \frac{1}{2} \right] &= \sum_{n=1}^{\infty} \frac{2n-1}{1+(2n-1)^2} \sin(2n-1)\pi x - \\ &\quad - \sum_{n=1}^{\infty} \frac{1}{2n-1} \sin(2n-1)\pi x. \end{aligned}$$

Based on the fact that

$$\frac{2n-1}{1+(2n-1)^2} - \frac{1}{2n-1} = -\frac{1}{(2n-1)[1+(2n-1)^2]},$$

and the fact that we can combine the two series, it follows that

$$g(x) = \frac{\pi}{2} \left[ f(x) - \frac{1}{2} \right] - \sum_{n=1}^{\infty} \frac{\sin(2n-1)\pi x}{(2n-1)[1+(2n-1)^2]}.$$

## Section 10.4

1. Since the function contains only odd powers of  $x$ , the function is *odd*.
2. Since the function contains both odd and even powers of  $x$ , the function is *neither* even nor odd.
4. We have  $\sec x = 1/\cos x$ . Since the *quotient* of two even functions is even, the function is *even*.
5. We can write  $|x|^3 = |x| \cdot |x|^2 = |x| \cdot x^2$ . Since both factors are even, it follows that the function is *even*.
8.  $L = 2$ .

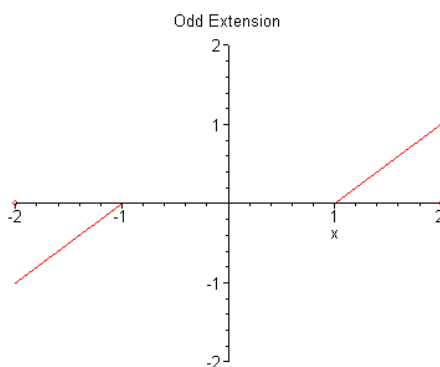
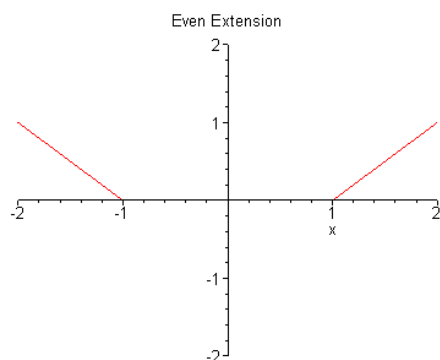

9.  $L = 2$ .

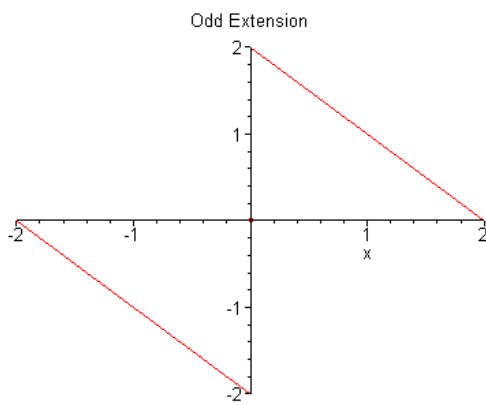
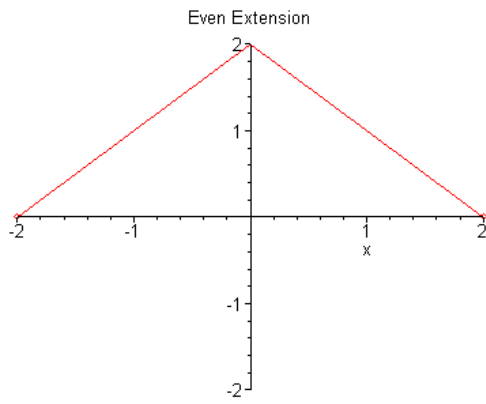

11.  $L = 2$ .

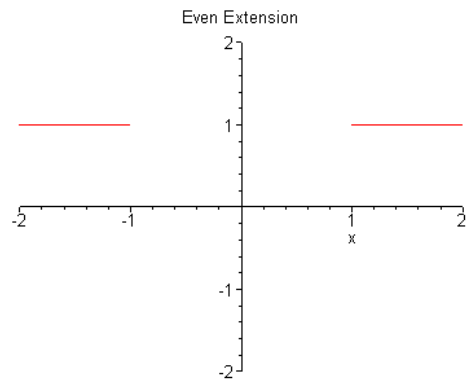

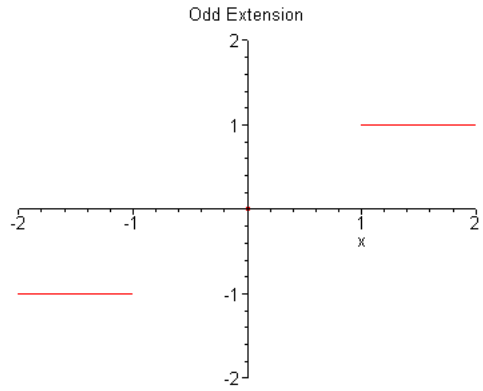

12.  $L = 1$ .

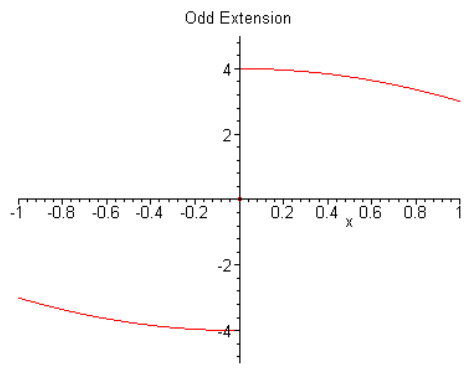
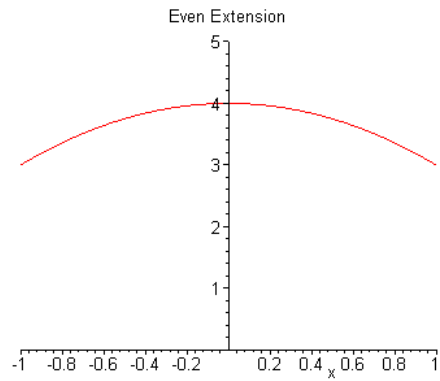

16.  $L = 2$ . For an *odd* extension of the function, the cosine coefficients are *zero*. The sine coefficients are given by

$$\begin{aligned}
 b_n &= \frac{2}{L} \int_0^L f(x) \sin \frac{n\pi x}{L} dx \\
 &= \int_0^1 x \sin \frac{n\pi x}{2} dx + \int_1^2 \sin \frac{n\pi x}{2} dx \\
 &= 2 \frac{2 \sin \frac{n\pi}{2} - n\pi \cos n\pi}{n^2 \pi^2}.
 \end{aligned}$$

Observe that

$$\sin\left(\frac{n\pi}{2}\right) = \begin{cases} 0, & n = 2k \\ (-1)^{k+1}, & n = 2k - 1 \end{cases}, \quad k = 1, 2, \dots$$

Likewise,

$$\cos n\pi = \begin{cases} 1, & n = 2k \\ -1, & n = 2k - 1 \end{cases}, \quad k = 1, 2, \dots$$

Therefore the Fourier sine series of the specified function is

$$f(x) = -\frac{1}{\pi} \sum_{n=1}^{\infty} \frac{1}{n} \sin n\pi x + \frac{2}{\pi^2} \sum_{n=1}^{\infty} \frac{2(-1)^{n+1} + (2n-1)\pi}{(2n-1)^2} \sin \frac{(2n-1)\pi x}{2}.$$

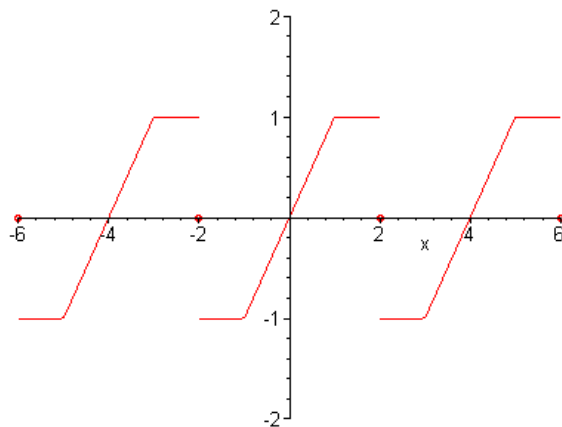

17.  $L = \pi$ . For an *even* extension of the function, the sine coefficients are *zero*. The cosine coefficients are given by

$$\begin{aligned}
 a_0 &= \frac{2}{L} \int_0^L f(x) dx \\
 &= \frac{2}{\pi} \int_0^{\pi} (1) dx \\
 &= 2,
 \end{aligned}$$

and for  $n > 0$ ,

$$\begin{aligned} a_n &= \frac{2}{L} \int_0^L f(x) \cos \frac{n\pi x}{L} dx \\ &= \frac{2}{\pi} \int_0^\pi (1) \cos nx dx \\ &= 0. \end{aligned}$$

The even extension of the given function is a *constant* function. As expected, the Fourier cosine series is

$$f(x) = \frac{a_0}{2} = 1.$$

19.  $L = 3\pi$ . For an *odd* extension of the function, the cosine coefficients are *zero*. The sine coefficients are given by

$$\begin{aligned} b_n &= \frac{2}{L} \int_0^L f(x) \sin \frac{n\pi x}{L} dx \\ &= \frac{2}{3\pi} \int_\pi^{2\pi} \sin \frac{nx}{3} dx + \frac{2}{3\pi} \int_{2\pi}^{3\pi} 2 \sin \frac{nx}{3} dx \\ &= -2 \frac{2 \cos n\pi - \cos \frac{n\pi}{3} - \cos \frac{2n\pi}{3}}{n\pi}. \end{aligned}$$

Therefore the Fourier sine series of the specified function is

$$f(x) = \frac{2}{\pi} \sum_{n=1}^{\infty} \frac{1}{n} \left[ \cos \frac{n\pi}{3} + \cos \frac{2n\pi}{3} - 2 \cos n\pi \right] \sin \frac{nx}{3}.$$

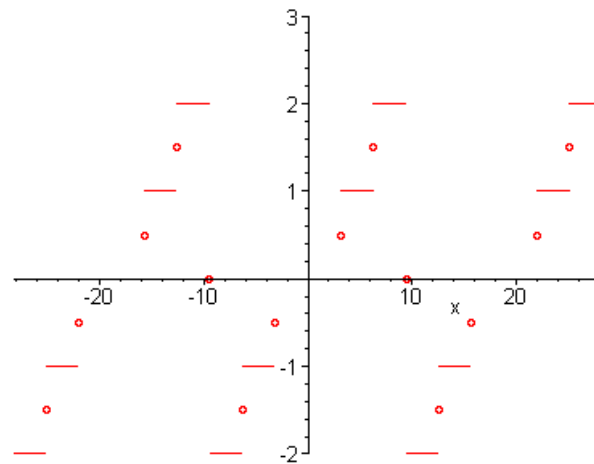



21. Extend the function over the interval  $[-L, L]$  as

$$f(x) = \begin{cases} x + L, & -L \leq x < 0 \\ L - x, & 0 \leq x \leq L. \end{cases}$$

Since the extended function is *even*, the sine coefficients are *zero*. The cosine coefficients are given by

$$\begin{aligned} a_0 &= \frac{2}{L} \int_0^L f(x) dx \\ &= \frac{2}{L} \int_0^L (L - x) dx \\ &= L, \end{aligned}$$

and for  $n > 0$ ,

$$\begin{aligned} a_n &= \frac{2}{L} \int_0^L f(x) \cos \frac{n\pi x}{L} dx \\ &= \frac{2}{L} \int_0^L (L - x) \cos \frac{n\pi x}{L} dx \\ &= 2L \frac{1 - \cos n\pi}{n^2 \pi^2}. \end{aligned}$$

Therefore the Fourier cosine series of the extended function is

$$f(x) = \frac{L}{2} + \frac{4L}{\pi^2} \sum_{n=1}^{\infty} \frac{1}{(2n-1)^2} \cos \frac{(2n-1)\pi x}{L}.$$

In order to compare the result with Example 1 of Section 10.2, set  $L = 2$ . The cosine series converges to the function graphed below:

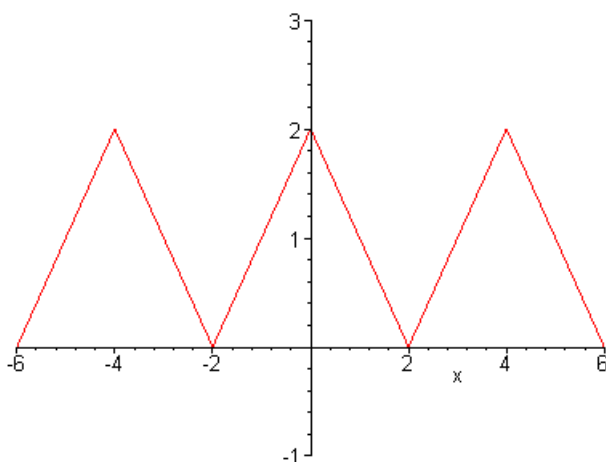

This function is a *shift* of the function in Example 1 of Section 10.2.

22. Extend the function over the interval  $[-L, L]$  as

$$f(x) = \begin{cases} -x - L, & -L \leq x < 0 \\ L - x, & 0 < x \leq L, \end{cases}$$

with  $f(0) = 0$ . Since the extended function is *odd*, the cosine coefficients are *zero*. The sine coefficients are given by

$$\begin{aligned} b_n &= \frac{2}{L} \int_0^L f(x) \sin \frac{n\pi x}{L} dx \\ &= \frac{2}{L} \int_0^L (L - x) \sin \frac{n\pi x}{L} dx \\ &= \frac{2L}{n\pi}. \end{aligned}$$

Therefore the Fourier cosine series of the extended function is

$$f(x) = \frac{2L}{\pi} \sum_{n=1}^{\infty} \frac{1}{n} \sin \frac{n\pi x}{L}.$$

Setting  $L = 2$ , for example, the series converges to the function graphed below:

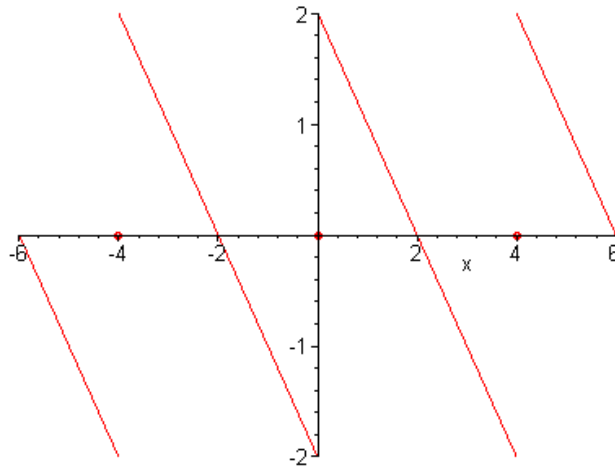

23(a).  $L = 2\pi$ . For an *even* extension of the function, the sine coefficients are *zero*. The cosine coefficients are given by

$$\begin{aligned} a_0 &= \frac{2}{L} \int_0^L f(x) dx \\ &= \frac{1}{\pi} \int_0^\pi x dx \\ &= \pi/2, \end{aligned}$$

and for  $n > 0$ ,

$$\begin{aligned} a_n &= \frac{2}{L} \int_0^L f(x) \cos \frac{n\pi x}{L} dx \\ &= \frac{1}{\pi} \int_0^\pi x \cos \frac{nx}{2} dx \\ &= 2 \frac{2 \cos\left(\frac{n\pi}{2}\right) + n\pi \sin\left(\frac{n\pi}{2}\right) - 2}{n^2\pi}. \end{aligned}$$

Therefore the Fourier cosine series of the given function is

$$f(x) = \frac{\pi}{4} + \frac{2}{\pi} \sum_{n=1}^{\infty} \left[ \frac{\pi}{n} \sin \frac{n\pi}{2} + \frac{2}{n^2} \left( \cos \frac{n\pi}{2} - 1 \right) \right] \cos \frac{nx}{2}.$$

Observe that

$$\sin\left(\frac{n\pi}{2}\right) = \begin{cases} 0, & n = 2k \\ (-1)^{k+1}, & n = 2k - 1 \end{cases}, \quad k = 1, 2, \dots$$

Likewise,

$$\cos\left(\frac{n\pi}{2}\right) = \begin{cases} (-1)^k, & n = 2k \\ 0, & n = 2k - 1 \end{cases}, k = 1, 2, \dots.$$

(b).

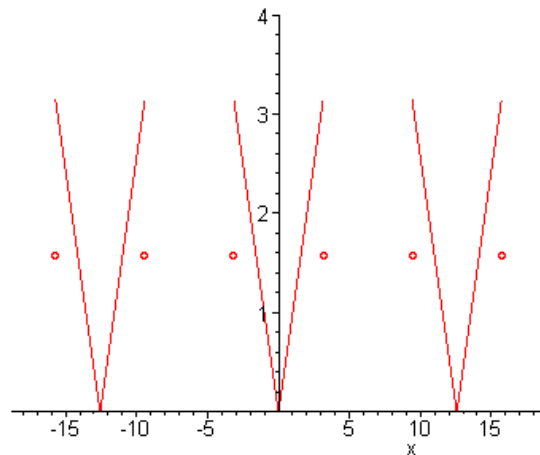

(c).

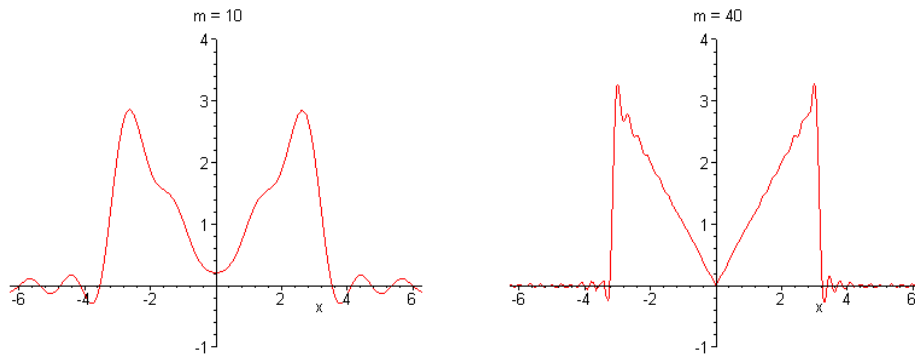

24(a).  $L = \pi$ . For an *odd* extension of the function, the cosine coefficients are *zero*. Note that  $f(x) = -x$  on  $0 \leq x < \pi$ . The sine coefficients are given by

$$\begin{aligned} b_n &= \frac{2}{L} \int_0^L f(x) \sin \frac{n\pi x}{L} dx \\ &= -\frac{2}{\pi} \int_0^\pi x \sin nx dx \\ &= \frac{2 \cos n\pi}{n}. \end{aligned}$$

Therefore the Fourier sine series of the given function is

$$f(x) = 2 \sum_{n=1}^{\infty} \frac{(-1)^n}{n} \sin nx.$$

(b).

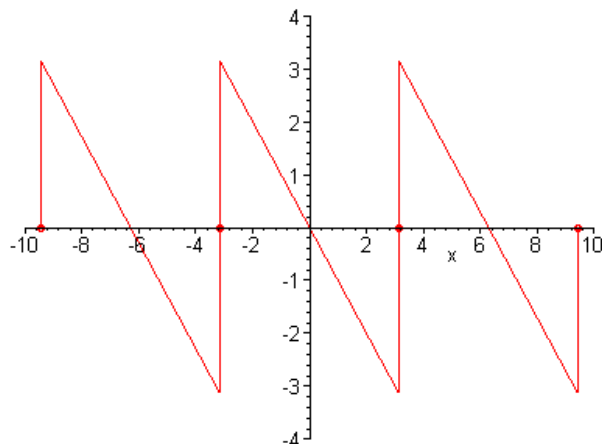

(c).

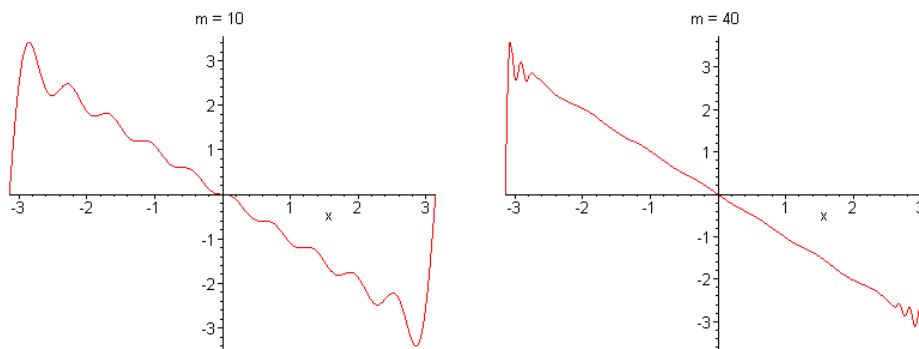

26(a).  $L = 4$ . For an *even* extension of the function, the sine coefficients are *zero*. The cosine coefficients are given by

$$\begin{aligned} a_0 &= \frac{2}{L} \int_0^L f(x) dx \\ &= \frac{1}{2} \int_0^4 (x^2 - 2x) dx \\ &= 8/3, \end{aligned}$$

and for  $n > 0$ ,

$$\begin{aligned}
 a_n &= \frac{2}{L} \int_0^L f(x) \cos \frac{n\pi x}{L} dx \\
 &= \frac{1}{2} \int_0^4 (x^2 - 2x) \cos \frac{n\pi x}{4} dx \\
 &= 16 \frac{1 + 3 \cos n\pi}{n^2 \pi^2}.
 \end{aligned}$$

Therefore the Fourier cosine series of the given function is

$$f(x) = \frac{4}{3} + \frac{16}{\pi^2} \sum_{n=1}^{\infty} \frac{1 + 3(-1)^n}{n^2} \cos \frac{n\pi x}{4}.$$

(b).

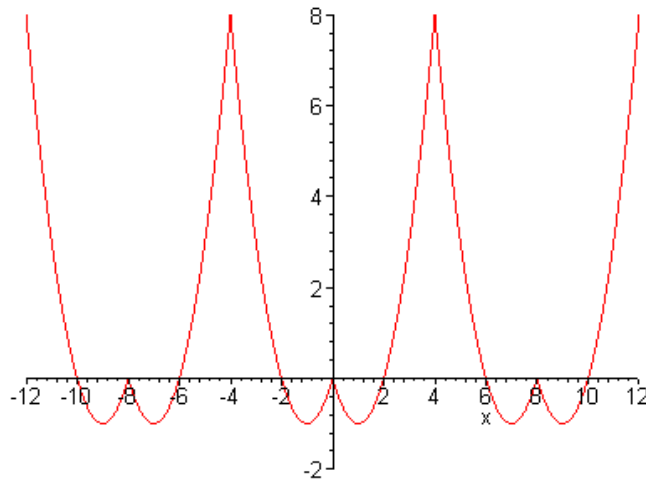

(c).

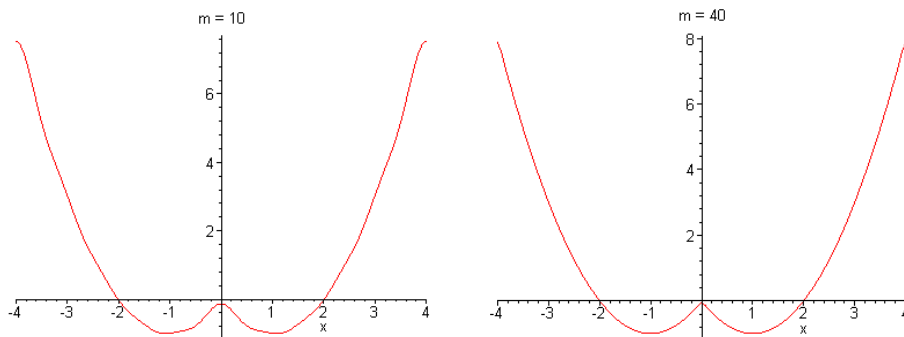

27(a).

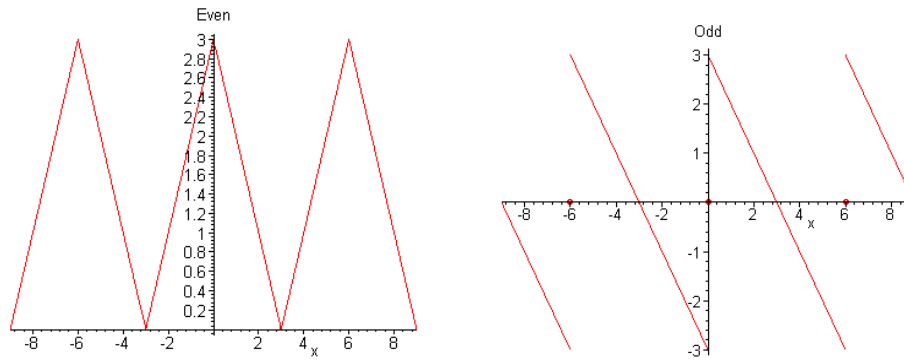

(b).  $L = 3$ . For an *even* extension of the function, the cosine coefficients are given by

$$\begin{aligned} a_0 &= \frac{2}{L} \int_0^L f(x) dx \\ &= \frac{2}{3} \int_0^3 (3-x) dx \\ &= 3, \end{aligned}$$

and for  $n > 0$ ,

$$\begin{aligned} a_n &= \frac{2}{L} \int_0^L f(x) \cos \frac{n\pi x}{L} dx \\ &= \frac{2}{3} \int_0^3 (3-x) \cos \frac{n\pi x}{3} dx \\ &= 6 \frac{1 - \cos n\pi}{n^2 \pi^2}. \end{aligned}$$

Therefore the Fourier cosine series of the given function is

$$g(x) = \frac{3}{2} + \frac{6}{\pi^2} \sum_{n=1}^{\infty} \frac{1 - (-1)^n}{n^2} \cos \frac{n\pi x}{3}.$$

For an *odd* extension of the function, the sine coefficients are given by

$$\begin{aligned} b_n &= \frac{2}{L} \int_0^L f(x) \sin \frac{n\pi x}{L} dx \\ &= \frac{2}{3} \int_0^3 (3-x) \sin \frac{n\pi x}{3} dx \\ &= \frac{6}{n\pi}. \end{aligned}$$

Therefore the Fourier sine series of the given function is

$$h(x) = \frac{6}{\pi} \sum_{n=1}^{\infty} \frac{1}{n} \sin \frac{n\pi x}{3}.$$

(c). For the *even* extension:

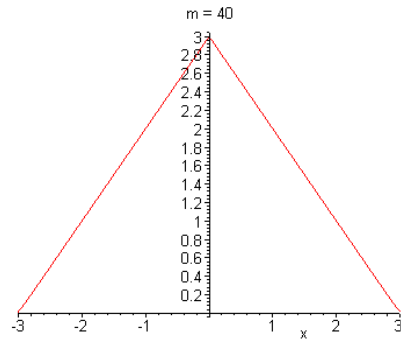
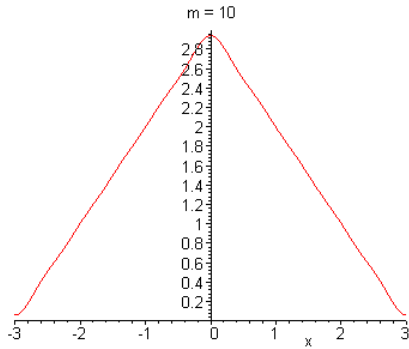

For the *odd* extension:

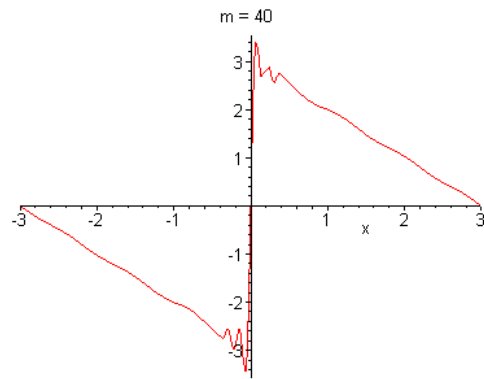
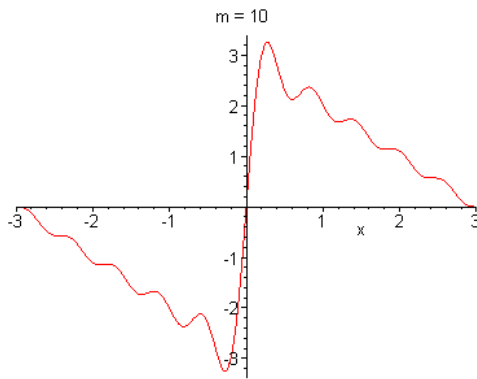

(d). Since the *even* extension is *continuous*, the series converges uniformly. On the other hand, the *odd* extension is *discontinuous*. Gibbs' phenomenon results in a finite error for all values of  $n$ .



29(a).

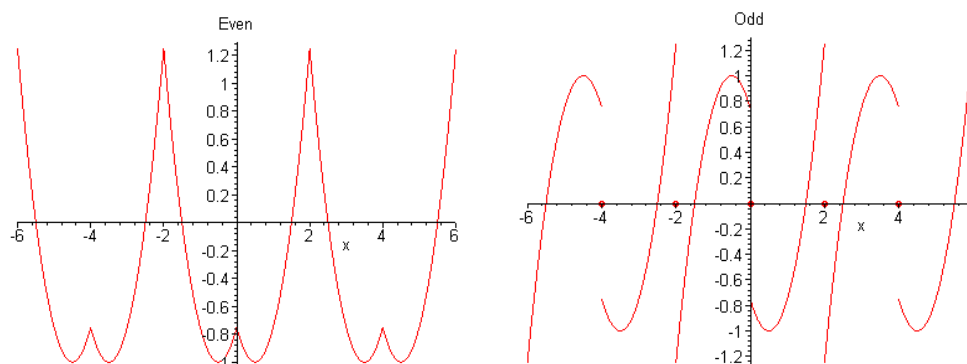

(b).  $L = 2$ . For an *even* extension of the function, the cosine coefficients are given by

$$\begin{aligned} a_0 &= \frac{2}{L} \int_0^L f(x) dx \\ &= \int_0^2 \left[ \frac{4x^2 - 4x - 3}{4} \right] dx \\ &= -5/6, \end{aligned}$$

and for  $n > 0$ ,

$$\begin{aligned} a_n &= \frac{2}{L} \int_0^L f(x) \cos \frac{n\pi x}{L} dx \\ &= \int_0^2 \left[ \frac{4x^2 - 4x - 3}{4} \right] \cos \frac{n\pi x}{2} dx \\ &= 4 \frac{1 + 3 \cos n\pi}{n^2 \pi^2}. \end{aligned}$$

Therefore the Fourier cosine series of the given function is

$$g(x) = -\frac{5}{12} + \frac{4}{\pi^2} \sum_{n=1}^{\infty} \frac{1 + 3(-1)^n}{n^2} \cos \frac{n\pi x}{2}.$$

For an *odd* extension of the function, the sine coefficients are given by

$$\begin{aligned} b_n &= \frac{2}{L} \int_0^L f(x) \sin \frac{n\pi x}{L} dx \\ &= \int_0^2 \left[ \frac{4x^2 - 4x - 3}{4} \right] \sin \frac{n\pi x}{2} dx \\ &= -\frac{32 + 3n^2\pi^2 + 5n^2\pi^2 \cos n\pi - 32 \cos n\pi}{2n^3\pi^3}. \end{aligned}$$

Therefore the Fourier sine series of the given function is

$$h(x) = -\frac{1}{2\pi^3} \sum_{n=1}^{\infty} \frac{32(1 - \cos n\pi) + n^2\pi^2(3 + 5 \cos n\pi)}{n^3} \sin \frac{n\pi x}{2}.$$

(c). For the *even* extension:

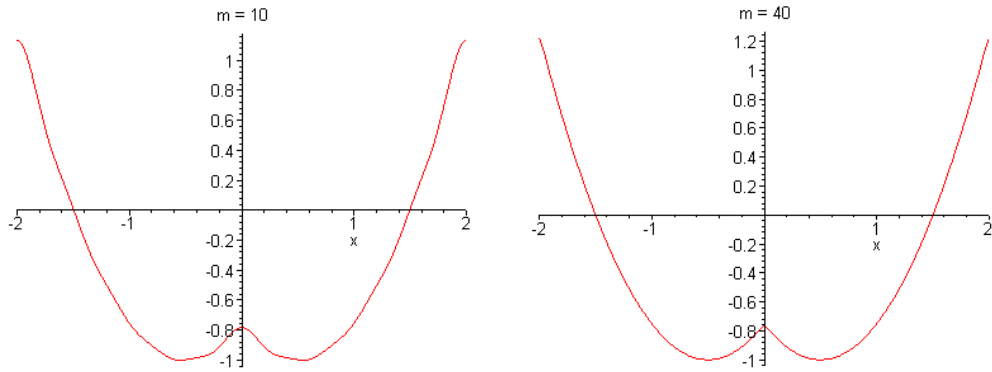

For the *odd* extension:

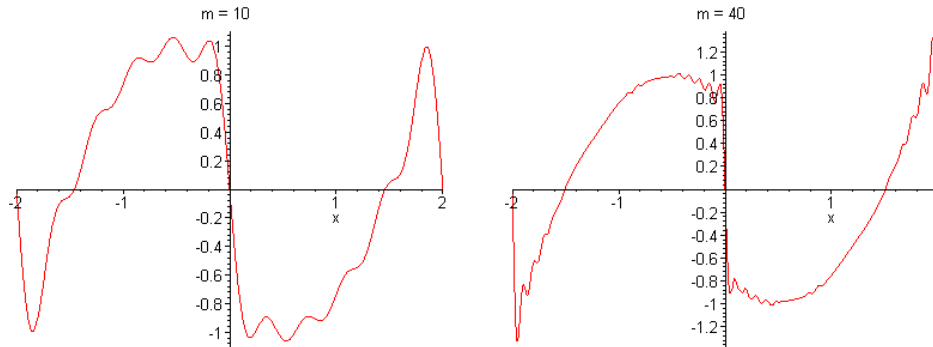

(d). Since the *even* extension is *continuous*, the series converges uniformly. On the other hand, the *odd* extension is *discontinuous*. Gibbs' phenomenon results in a finite error for all values of  $n$ .

30(a).

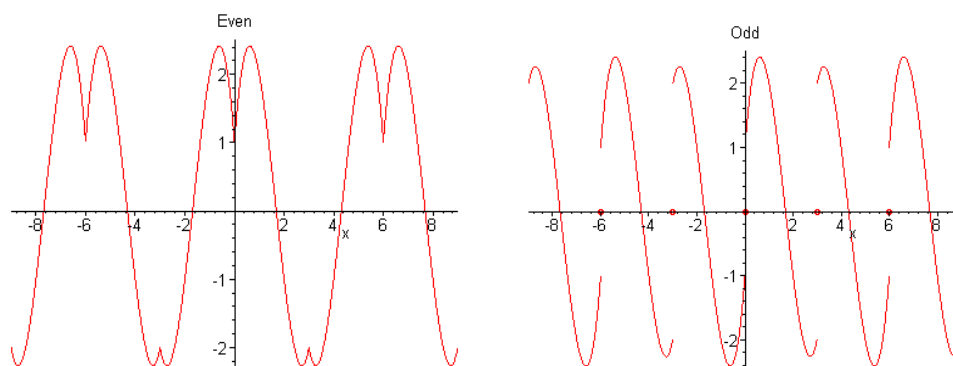

(b).  $L = 3$ . For an *even* extension of the function, the cosine coefficients are given by

$$\begin{aligned} a_0 &= \frac{2}{L} \int_0^L f(x) dx \\ &= \frac{2}{3} \int_0^3 (x^3 - 5x^2 + 5x + 1) dx \\ &= 1/2, \end{aligned}$$

and for  $n > 0$ ,

$$\begin{aligned} a_n &= \frac{2}{L} \int_0^L f(x) \cos \frac{n\pi x}{L} dx \\ &= \frac{2}{3} \int_0^3 (x^3 - 5x^2 + 5x + 1) \cos \frac{n\pi x}{3} dx \\ &= 2 \frac{162 - 15n^2\pi^2 + 6n^2\pi^2 \cos n\pi - 162 \cos n\pi}{n^4\pi^4}. \end{aligned}$$

Therefore the Fourier cosine series of the given function is

$$g(x) = \frac{1}{4} + \frac{2}{\pi^4} \sum_{n=1}^{\infty} \frac{162(1 - \cos n\pi) - 3n^2\pi^2(5 - 2 \cos n\pi)}{n^4} \cos \frac{n\pi x}{3}.$$

For an *odd* extension of the function, the sine coefficients are given by

$$\begin{aligned} b_n &= \frac{2}{L} \int_0^L f(x) \sin \frac{n\pi x}{L} dx \\ &= \frac{2}{3} \int_0^3 (x^3 - 5x^2 + 5x + 1) \sin \frac{n\pi x}{3} dx \\ &= 2 \frac{90 + n^2\pi^2 + 2n^2\pi^2 \cos n\pi + 72 \cos n\pi}{n^3\pi^3}. \end{aligned}$$

Therefore the Fourier sine series of the given function is

$$h(x) = \frac{2}{\pi^3} \sum_{n=1}^{\infty} \frac{18(5 + 4 \cos n\pi) + n^2 \pi^2 (1 + 2 \cos n\pi)}{n^3} \sin \frac{n\pi x}{3}.$$

(c). For the *even* extension:

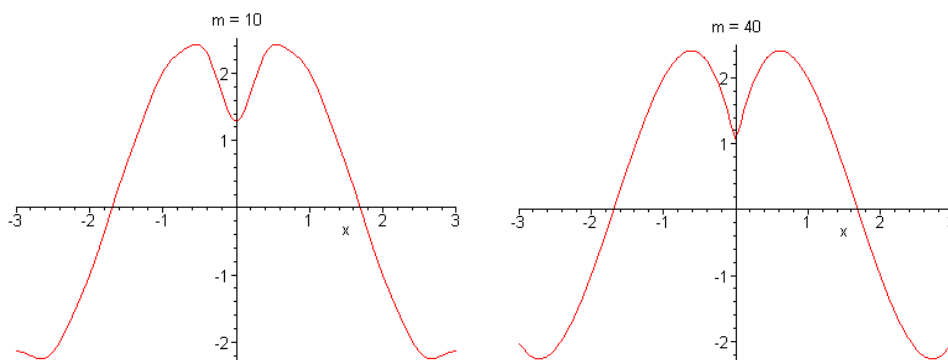

For the *odd* extension:

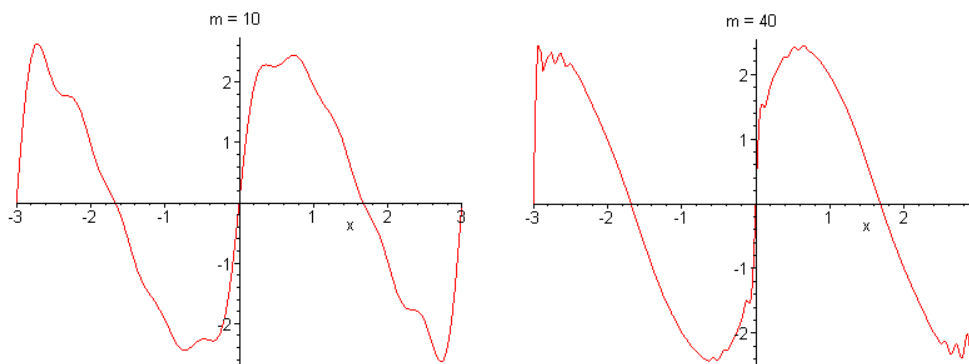

(d). Since the *even* extension is *continuous*, the series converges uniformly. On the other hand, the *odd* extension is *discontinuous*. Gibbs' phenomenon results in a finite error for all values of  $n$ ; particularly at  $x = \pm 3$ .

33. Let  $f(x)$  be a differentiable *even* function. For any  $x$  in its domain,

$$f(-x+h) - f(-x) = f(x-h) - f(x).$$

It follows that

$$\begin{aligned}
 f'(-x) &= \lim_{h \rightarrow 0} \frac{f(-x+h) - f(-x)}{h} \\
 &= \lim_{h \rightarrow 0} \frac{f(x-h) - f(x)}{h} \\
 &= - \lim_{h \rightarrow 0} \frac{f(x-h) - f(x)}{(-h)}.
 \end{aligned}$$

Setting  $h = -\delta$ , we have

$$\begin{aligned}
 f'(-x) &= - \lim_{h \rightarrow 0} \frac{f(x+\delta) - f(x)}{\delta} \\
 &= - \lim_{-\delta \rightarrow 0} \frac{f(x+\delta) - f(x)}{\delta} \\
 &= -f'(x).
 \end{aligned}$$

Therefore  $f'(-x) = -f'(x)$ .

If  $f(x)$  is a differentiable *odd* function, for any  $x$  in its domain,

$$f(-x+h) - f(-x) = -f(x-h) + f(x).$$

It follows that

$$\begin{aligned}
 f'(-x) &= \lim_{h \rightarrow 0} \frac{f(-x+h) - f(-x)}{h} \\
 &= \lim_{h \rightarrow 0} \frac{-f(x-h) + f(x)}{h} \\
 &= \lim_{h \rightarrow 0} \frac{f(x-h) - f(x)}{(-h)}.
 \end{aligned}$$

Setting  $h = -\delta$ , we have

$$\begin{aligned}
 f'(-x) &= \lim_{h \rightarrow 0} \frac{f(x+\delta) - f(x)}{\delta} \\
 &= \lim_{-\delta \rightarrow 0} \frac{f(x+\delta) - f(x)}{\delta} \\
 &= f'(x).
 \end{aligned}$$

Therefore  $f'(-x) = f'(x)$ .

36. From Example 1 of Section 10.2, the function

$$f(x) = \begin{cases} -x, & -2 \leq x < 0 \\ x, & 0 \leq x < 2, \end{cases}$$

( $L = 2$ ) has a convergent Fourier series

$$f(x) = 1 - \frac{8}{\pi^2} \sum_{n=1}^{\infty} \frac{1}{(2n-1)^2} \cos \frac{(2n-1)\pi x}{2}.$$

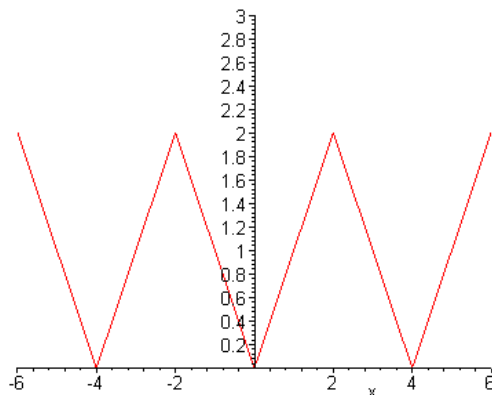

Since  $f(x)$  is continuous, the series converges everywhere. In particular, at  $x = 0$ , we have

$$0 = f(0) = 1 - \frac{8}{\pi^2} \sum_{n=1}^{\infty} \frac{1}{(2n-1)^2}.$$

It follows immediately that

$$\frac{\pi^2}{8} = \sum_{n=1}^{\infty} \frac{1}{(2n-1)^2} = 1 + \frac{1}{3^2} + \frac{1}{5^2} + \frac{1}{7^2} + \cdots.$$

40. Since one objective is to obtain a Fourier series containing only *cosine* terms, any extension of  $f(x)$  should be an *even* function. Another objective is to derive a series containing only the terms

$$\cos \frac{(2n-1)\pi x}{2L}, \quad n = 1, 2, \dots.$$

First note that the functions

$$\cos \frac{n\pi x}{L}, \quad n = 1, 2, \dots$$

are *symmetric* about  $x = L$ . Indeed,

$$\begin{aligned}
\cos \frac{n\pi(2L-x)}{L} &= \cos \left( 2n\pi - \frac{n\pi x}{L} \right) \\
&= \cos \left( -\frac{n\pi x}{L} \right) \\
&= \cos \frac{n\pi x}{L}.
\end{aligned}$$

It follows that if  $f(x)$  is extended into  $(L, 2L)$  as an *antisymmetric* function about  $x = L$ ,

that is,  $f(2L-x) = -f(x)$  for  $0 \leq x \leq 2L$ , then

$$\int_0^{2L} f(x) \cos \frac{n\pi x}{L} dx = 0.$$

This follows from the fact that the integrand is *antisymmetric* function about  $x = L$ .

Now

extend the function  $f(x)$  to obtain

$$\tilde{f}(x) = \begin{cases} f(x), & 0 \leq x < L \\ -f(2L-x), & L < x < 2L. \end{cases}$$

Finally, extend the resulting function into  $(-2L, 0)$  as an *even* function, and then as a periodic function of period  $4L$ .

By construction, the Fourier series will contain only *cosine* terms. We first note that

$$\begin{aligned}
a_0 &= \frac{2}{2L} \int_0^{2L} \tilde{f}(x) dx \\
&= \frac{1}{L} \int_0^L f(x) dx - \frac{1}{L} \int_L^{2L} f(2L-x) dx \\
&= \frac{1}{L} \int_0^L f(x) dx - \frac{1}{L} \int_0^L f(u) du \\
&= 0.
\end{aligned}$$

For  $n > 0$ ,

$$\begin{aligned}
a_n &= \frac{2}{2L} \int_0^{2L} \tilde{f}(x) \cos \frac{n\pi x}{2L} dx \\
&= \frac{1}{L} \int_0^L f(x) \cos \frac{n\pi x}{2L} dx - \frac{1}{L} \int_L^{2L} f(2L-x) \cos \frac{n\pi x}{2L} dx.
\end{aligned}$$

For the second integral, let  $u = 2L - x$ . Then

$$\cos \frac{n\pi x}{2L} = \cos \frac{n\pi(2L+u)}{2L} = (-1)^n \cos \frac{n\pi u}{2L}$$

and therefore

$$\int_L^{2L} f(2L - x) \cos \frac{n\pi x}{2L} dx = (-1)^n \int_0^L f(u) \cos \frac{n\pi u}{2L} du.$$

Hence

$$a_n = \frac{1 - (-1)^n}{L} \int_0^L f(x) \cos \frac{n\pi x}{2L} dx.$$

It immediately follows that  $a_n = 0$  for  $n = 2k$ ,  $k = 0, 1, 2, \dots$ , and

$$a_{2k-1} = \frac{2}{L} \int_0^L f(x) \cos \frac{(2k-1)\pi x}{2L} dx, \text{ for } k = 1, 2, \dots.$$

The associated Fourier series representation

$$f(x) = \sum_{n=0}^{\infty} a_{2n-1} \cos \frac{(2n-1)\pi x}{2L}$$

converges almost everywhere on  $(-2L, 2L)$  and hence on  $(0, L)$ .

For example, if  $f(x) = x$  for  $0 \leq x \leq L = 1$ , the graph of the extended function is:

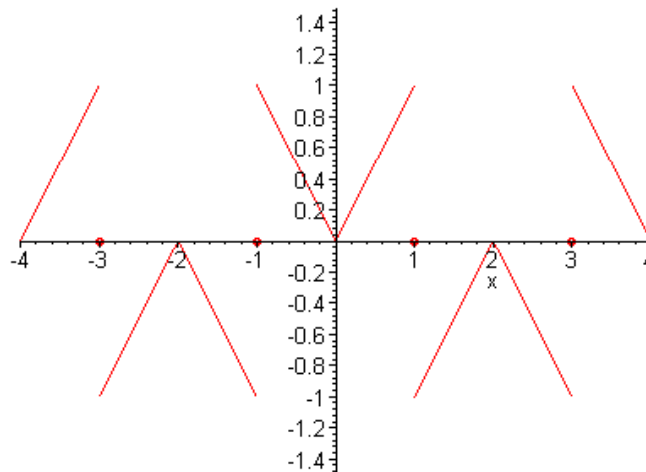



## Section 10.5

1. We consider solutions of the form  $u(x, t) = X(x)T(t)$ . Substitution into the partial differential equation results in

$$xX''T + XT' = 0.$$

Divide both sides of the differential equation by the product  $XT$  to obtain

$$x\frac{X''}{X} + \frac{T'}{T} = 0,$$

so that

$$x\frac{X''}{X} = -\frac{T'}{T}.$$

Since both sides of the resulting equation are functions of different variables, each must be equal to a constant, say  $\lambda$ . We obtain the ordinary differential equations

$$xX'' - \lambda X = 0 \text{ and } T' + \lambda T = 0.$$

2. In order to apply the method of separation of variables, we consider solutions of the form  $u(x, t) = X(x)T(t)$ . Substituting the assumed form of the solution into the partial differential equation, we obtain

$$tX''T + xXT' = 0.$$

Divide both sides of the differential equation by the product  $xtXT$  to obtain

$$\frac{X''}{xX} + \frac{T'}{tT} = 0,$$

so that

$$\frac{X''}{xX} = -\frac{T'}{tT}.$$

Since both sides of the resulting equation are functions of *different* variables, it follows that

$$\frac{X''}{xX} = -\frac{T'}{tT} = \lambda.$$

Therefore  $X(x)$  and  $T(t)$  are solutions of the ordinary differential equations

$$X'' - \lambda x X = 0 \text{ and } T' + \lambda t T = 0.$$

4. Assume that the solution of the PDE has the form  $u(x, t) = X(x)T(t)$ . Substitution into the partial differential equation results in

$$[p(x)X']'T - r(x)XT'' = 0.$$

Divide both sides of the differential equation by the product  $r(x)XT$  to obtain

$$\frac{[p(x)X']'}{r(x)X} - \frac{T''}{T} = 0,$$

that is,

$$\frac{[p(x)X']'}{r(x)X} = \frac{T''}{T}.$$

Since both sides of the resulting equation are functions of different variables, each must be equal to a constant, say  $-\lambda$ . We obtain the ordinary differential equations

$$[p(x)X']' + \lambda r(x)X = 0 \text{ and } T'' + \lambda T = 0.$$

6. We consider solutions of the form  $u(x, y) = X(x)Y(y)$ . Substitution into the partial differential equation results in

$$X''Y + XY'' + xXY = 0.$$

Divide both sides of the differential equation by the product  $XY$  to obtain

$$\frac{X''}{X} + \frac{Y''}{Y} + x = 0,$$

that is,

$$\frac{X''}{X} + x = -\frac{Y''}{Y}.$$

Since both sides of the resulting equation are functions of *different* variables, it follows that

$$\frac{X''}{X} + x = -\frac{Y''}{Y} = -\lambda.$$

We obtain the ordinary differential equations

$$X'' + (x + \lambda)X = 0 \text{ and } Y'' - \lambda Y = 0.$$

7. The heat conduction equation,  $100 u_{xx} = u_t$ , and the given boundary conditions are homogeneous. We consider solutions of the form  $u(x, t) = X(x)T(t)$ . Substitution into the partial differential equation results in

$$100 X''T = XT'.$$

Divide both sides of the differential equation by the product  $XT$  to obtain

$$\frac{X''}{X} = \frac{T'}{100T}.$$

Since both sides of the resulting equation are functions of *different* variables, it follows that

$$\frac{X''}{X} = \frac{T'}{100T} = -\lambda.$$

Therefore  $X(x)$  and  $T(t)$  are solutions of the ordinary differential equations

$$X'' + \lambda X = 0 \text{ and } T' + 100\lambda T = 0.$$

The general solution of the *spatial* equation is  $X = c_1 \cos \lambda^{1/2}x + c_2 \sin \lambda^{1/2}x$ . In order to satisfy the homogeneous boundary conditions, we require that  $c_1 = 0$ , and

$$\lambda^{1/2} = n\pi.$$

Hence the eigenfunctions are  $X_n = \sin n\pi x$ , with associated eigenvalues  $\lambda_n = n^2\pi^2$ .

We thus obtain the family of equations  $T' + 100\lambda_n T = 0$ . Solution are given by

$$T_n = e^{-100\lambda_n t}.$$

Hence the fundamental solutions of the PDE are

$$u_n(x, t) = e^{-100n^2\pi^2 t} \sin n\pi x,$$

which yield the general solution

$$u(x, t) = \sum_{n=1}^{\infty} c_n e^{-100n^2\pi^2 t} \sin n\pi x.$$

Finally, the initial condition  $u(x, 0) = \sin 2\pi x - \sin 5\pi x$  must be satisfied. Therefore is it necessary that

$$\sum_{n=1}^{\infty} c_n \sin n\pi x = \sin 2\pi x - \sin 5\pi x.$$

It follows from the *orthogonality* conditions that  $c_2 = -c_5 = 1$ , with all other  $c_n = 0$ . Therefore the solution of the given heat conduction problem is

$$u(x, t) = e^{-400\pi^2 t} \sin 2\pi x - e^{-2500\pi^2 t} \sin 5\pi x.$$

9. The heat conduction problem is formulated as

$$\begin{aligned} u_{xx} &= u_t, & 0 < x < 40, \quad t > 0; \\ u(0, t) &= 0, & u(40, t) &= 0, \quad t > 0; \\ u(x, 0) &= 50, & 0 < x < 40. \end{aligned}$$

Assume a solution of the form  $u(x, t) = X(x)T(t)$ . Following the procedure in this section, we obtain the eigenfunctions  $X_n = \sin n\pi x/40$ , with associated eigenvalues  $\lambda_n = n^2\pi^2/1600$ . The solutions of the *temporal* equations are

$$T_n = e^{-\lambda_n t}.$$

Hence the general solution of the given problem is

$$u(x, t) = \sum_{n=1}^{\infty} c_n e^{-n^2\pi^2 t/1600} \sin \frac{n\pi x}{40}.$$

The coefficients  $c_n$  are the *Fourier sine* coefficients of  $u(x, 0) = 50$ . That is,

$$\begin{aligned} c_n &= \frac{2}{L} \int_0^L f(x) \sin \frac{n\pi x}{L} dx \\ &= \frac{5}{2} \int_0^{40} \sin \frac{n\pi x}{40} dx \\ &= 100 \frac{1 - \cos n\pi}{n\pi}. \end{aligned}$$

The sine series of the initial condition is

$$50 = \frac{100}{\pi} \sum_{n=1}^{\infty} \frac{1 - \cos n\pi}{n} \sin \frac{n\pi x}{40}.$$

Therefore the solution of the given heat conduction problem is

$$u(x, t) = \frac{100}{\pi} \sum_{n=1}^{\infty} \frac{1 - \cos n\pi}{n} e^{-n^2\pi^2 t/1600} \sin \frac{n\pi x}{40}.$$

11. Refer to Prob. 9 for the formulation of the problem. In this case, the initial condition is given by

$$u(x, 0) = \begin{cases} 0, & 0 \leq x < 10, \\ 50, & 10 \leq x \leq 30, \\ 0, & 30 < x \leq 40. \end{cases}$$

All other data being the same, the solution of the given problem is

$$u(x, t) = \sum_{n=1}^{\infty} c_n e^{-n^2\pi^2 t/1600} \sin \frac{n\pi x}{40}.$$

The coefficients  $c_n$  are the *Fourier sine* coefficients of  $u(x, 0)$ . That is,

$$\begin{aligned} c_n &= \frac{2}{L} \int_0^L f(x) \sin \frac{n\pi x}{L} dx \\ &= \frac{5}{2} \int_{10}^{30} \sin \frac{n\pi x}{40} dx \\ &= 100 \frac{\cos \frac{n\pi}{4} - \cos \frac{3n\pi}{4}}{n\pi}. \end{aligned}$$

Therefore the solution of the given heat conduction problem is

$$u(x, t) = \frac{100}{\pi} \sum_{n=1}^{\infty} \frac{\cos \frac{n\pi}{4} - \cos \frac{3n\pi}{4}}{n} e^{-n^2\pi^2 t/1600} \sin \frac{n\pi x}{40}.$$

12. Refer to Prob. 9 for the formulation of the problem. In this case, the initial condition is given by

$$u(x, 0) = x, \quad 0 < x < 40.$$

All other data being the same, the solution of the given problem is

$$u(x, t) = \sum_{n=1}^{\infty} c_n e^{-n^2\pi^2 t/1600} \sin \frac{n\pi x}{40}.$$

The coefficients  $c_n$  are the *Fourier sine* coefficients of  $u(x, 0) = x$ . That is,

$$\begin{aligned} c_n &= \frac{2}{L} \int_0^L f(x) \sin \frac{n\pi x}{L} dx \\ &= \frac{1}{20} \int_0^{40} x \sin \frac{n\pi x}{40} dx \\ &= -80 \frac{\cos n\pi}{n\pi}. \end{aligned}$$

Therefore the solution of the given heat conduction problem is

$$u(x, t) = \frac{80}{\pi} \sum_{n=1}^{\infty} \frac{(-1)^{n+1}}{n} e^{-n^2\pi^2 t/1600} \sin \frac{n\pi x}{40}.$$

13. Substituting  $x = 20$ , into the solution, we have

$$u(20, t) = \frac{100}{\pi} \sum_{n=1}^{\infty} \frac{1 - \cos n\pi}{n} e^{-n^2\pi^2 t/1600} \sin \frac{n\pi}{2}.$$

We can also write

$$u(20, t) = \frac{200}{\pi} \sum_{k=1}^{\infty} \frac{(-1)^{k+1}}{2k-1} e^{-(2k-1)^2\pi^2 t/1600}.$$

Therefore,

$$u(20, 5) = \frac{200}{\pi} \sum_{k=1}^{\infty} \frac{(-1)^{k+1}}{2k-1} e^{-(2k-1)^2\pi^2/320}.$$

Let

$$A_k = \frac{(-1)^{n+1}200}{\pi(2k-1)} e^{-(2k-1)^2\pi^2/320}.$$

It follows that  $|A_k| < 0.005$  for  $k \geq 9$ . So for  $n = 2k - 1 \geq 17$ , the summation is unaffected by additional terms.

For  $t = 20$ ,

$$u(20, 20) = \frac{200}{\pi} \sum_{k=1}^{\infty} \frac{(-1)^{k+1}}{2k-1} e^{-(2k-1)^2\pi^2/80}.$$

Let

$$A_k = \frac{(-1)^{n+1}200}{\pi(2k-1)} e^{-(2k-1)^2\pi^2/80}.$$

It follows that  $|A_k| < 0.003$  for  $k \geq 5$ . So for  $n = 2k - 1 \geq 9$ , the summation is unaffected by additional terms.

For  $t = 80$ ,

$$u(20, 80) = \frac{200}{\pi} \sum_{k=1}^{\infty} \frac{(-1)^{k+1}}{2k-1} e^{-(2k-1)^2\pi^2/20}.$$

Let

$$A_k = \frac{(-1)^{n+1}200}{\pi(2k-1)} e^{-(2k-1)^2\pi^2/20}.$$

It follows that  $|A_k| < 0.00005$  for  $k \geq 3$ . So for  $n = 2k - 1 \geq 5$ , the summation is unaffected by additional terms.

The series solution converges *faster* as  $t$  increases.

14(a). The solution of the given heat conduction problem is

$$u(x, t) = \frac{100}{\pi} \sum_{n=1}^{\infty} \frac{1 - \cos n\pi}{n} e^{-n^2\pi^2 t/1600} \sin \frac{n\pi x}{40}.$$

Setting  $t = 5, 10, 20, 40, 100, 200$  :

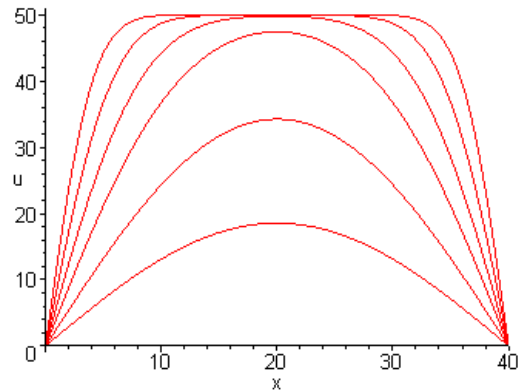

(b). Setting  $x = 5, 10, 15, 20$  :

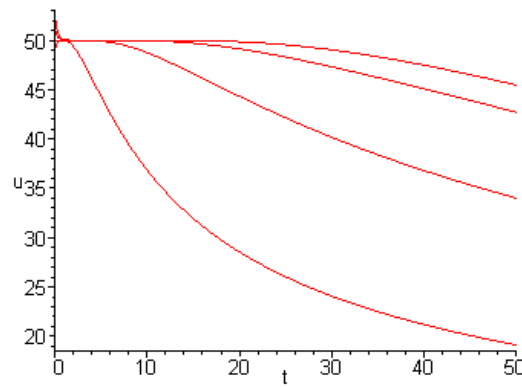

(c). Surface plot of  $u(x, t)$  :

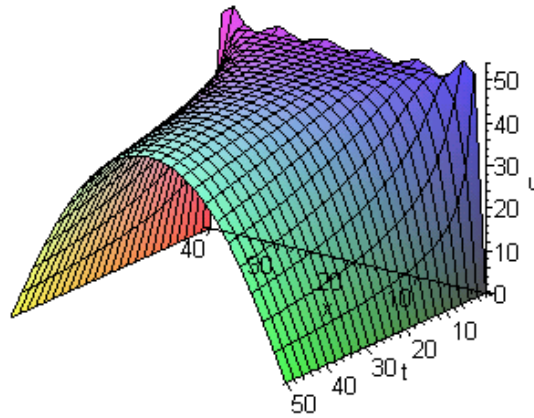

(d).  $0 \leq u(x, t) \leq 1$  for  $t \geq 675$  sec .

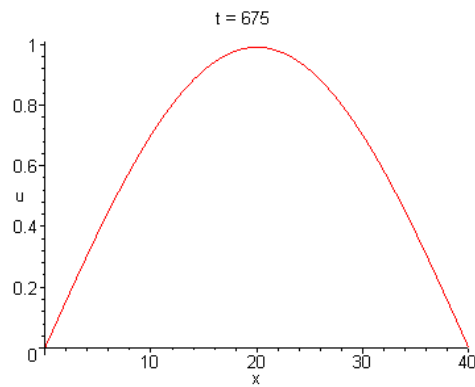

16(a). The solution of the given heat conduction problem is

$$u(x, t) = \frac{100}{\pi} \sum_{n=1}^{\infty} \frac{\cos \frac{n\pi}{4} - \cos \frac{3n\pi}{4}}{n} e^{-n^2 \pi^2 t / 1600} \sin \frac{n\pi x}{40} .$$



Setting  $t = 5, 10, 20, 40, 100, 200$  :

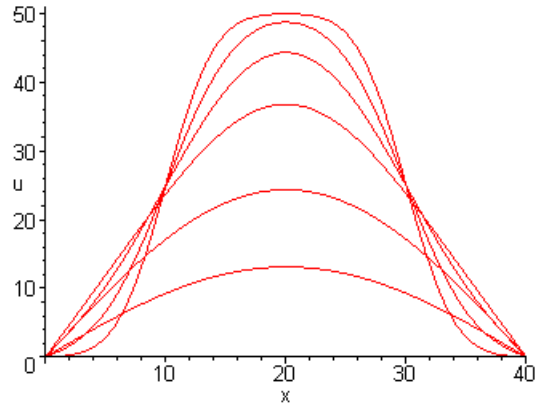

(b). Setting  $x = 5, 10, 15, 20$  :

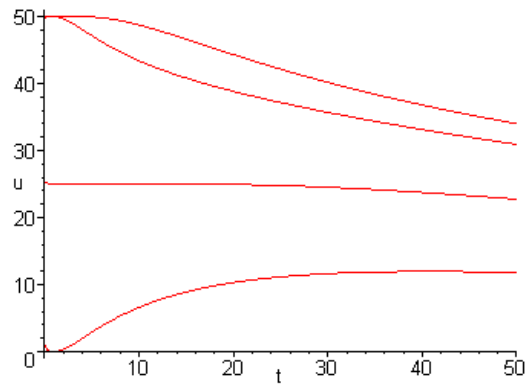

(c). Surface plot of  $u(x, t)$  :

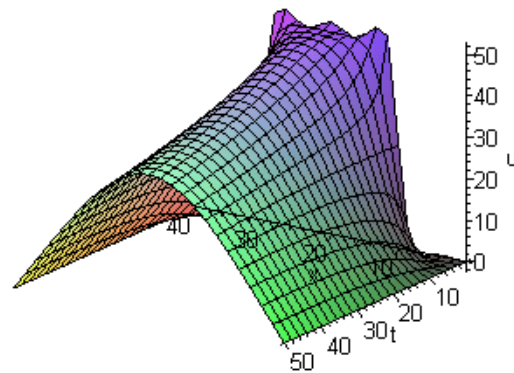

(d).  $0 \leq u(x, t) \leq 1$  for  $t \geq 615 \text{ sec.}$

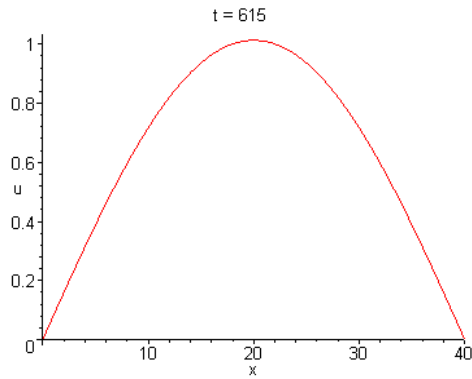

17(a). The solution of the given heat conduction problem is

$$u(x, t) = \frac{80}{\pi} \sum_{n=1}^{\infty} \frac{(-1)^{n+1}}{n} e^{-n^2\pi^2t/1600} \sin \frac{n\pi x}{40}.$$

Setting  $t = 5, 10, 20, 40, 100, 200$  :

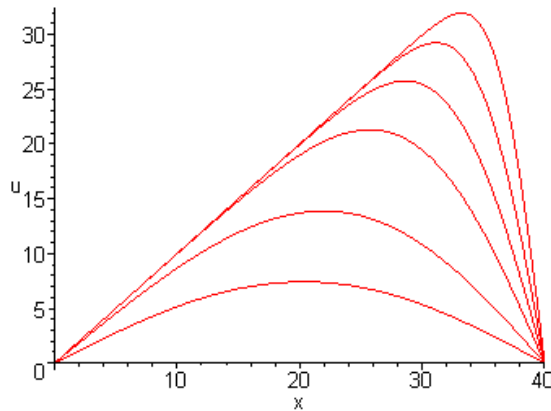

(b). Analyzing the individual plots, we find that the 'hot spot' varies with time:

$t$	5	10	20	40	100	200
$x_h$	33	31	29	26	22	21

Location of the 'hot spot',  $x_h$ , versus *time* :

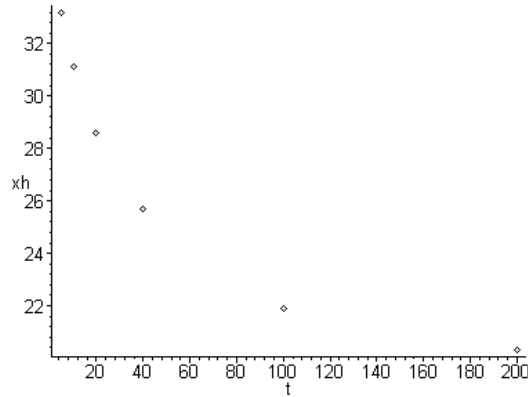

Evidently, the location of the greatest temperature migrates to the center of the rod.

(c). Setting  $x = 5, 10, 15, 20$  :

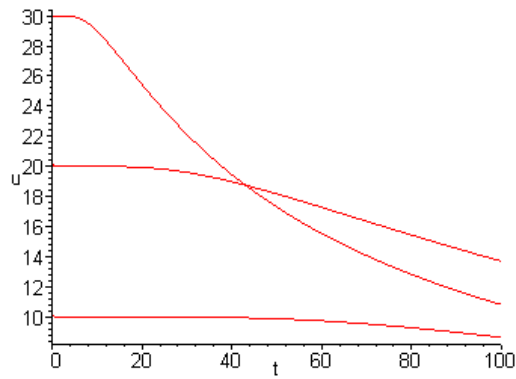

(d). Surface plot of  $u(x, t)$  :

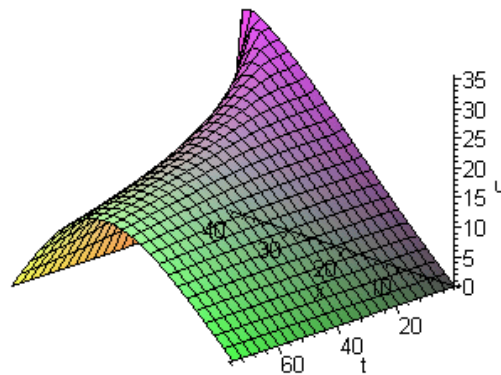

(e).  $0 \leq u(x, t) \leq 1$  for  $t \geq 525$  sec .

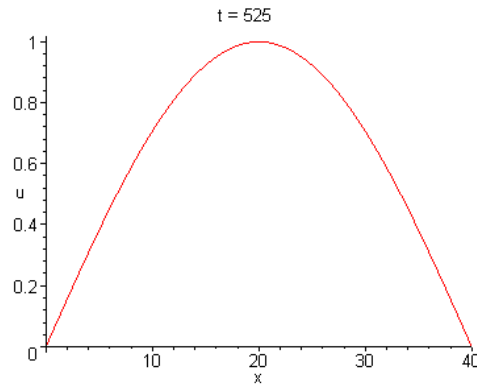

19. The solution of the given heat conduction problem is

$$u(x, t) = \frac{200}{\pi} \sum_{n=1}^{\infty} \frac{1 - \cos n\pi}{n} e^{-n^2\pi^2\alpha^2t/400} \sin \frac{n\pi x}{20} .$$

Setting  $x = 10$  cm ,

$$u(10, t) = \frac{200}{\pi} \sum_{n=1}^{\infty} \frac{1 - \cos n\pi}{n} e^{-n^2\pi^2\alpha^2t/400} \sin \frac{n\pi}{2} .$$

A *two-term* approximation is given by

$$u(10, t) \approx \frac{400}{3\pi} \left[ 3e^{-\pi^2\alpha^2t/400} - e^{-9\pi^2\alpha^2t/400} \right] .$$

From Table 10.5.1 :

	$\alpha^2$
<i>silver</i>	1.71
<i>aluminum</i>	0.86
<i>cast iron</i>	0.12

(a).  $\alpha^2 = 1.71$  :

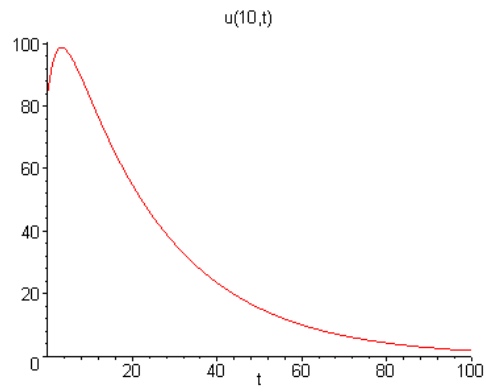

(b).  $\alpha^2 = 0.86$  :

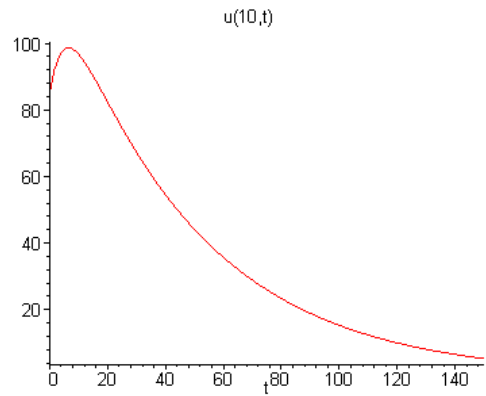

(c).  $\alpha^2 = 0.12$  :

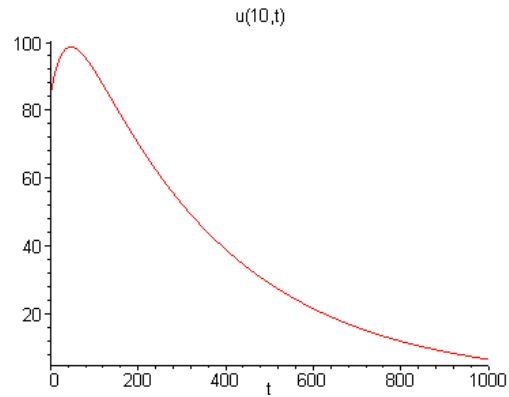

21(a). Given the partial differential equation

$$a u_{xx} - b u_t + c u = 0,$$

in which  $a$ ,  $b$ , and  $c$  are constants, set  $u(x, t) = e^{\delta t} w(x, t)$ . Substitution into the PDE results in

$$a e^{\delta t} w_{xx} - b(\delta e^{\delta t} w + e^{\delta t} w_t) + c e^{\delta t} w = 0.$$

Dividing both sides of the equation by  $e^{\delta t}$ , we obtain

$$a w_{xx} - b w_t + (c - b\delta) w = 0.$$

As long as  $b \neq 0$ , choosing  $\delta = c/b$  yields

$$\frac{a}{b} w_{xx} - w_t = 0,$$

which is the *heat conduction equation* with dependent variable  $w$ .

23. The heat conduction equation in *polar coordinates* is given by

$$\alpha^2 \left[ u_{rr} + \frac{1}{r} u_r + \frac{1}{r^2} u_{\theta\theta} \right] = u_t.$$

We consider solutions of the form  $u(r, \theta, t) = R(r)\Theta(\theta)T(t)$ . Substitution into the PDE results in

$$\alpha^2 \left[ R''\Theta T + \frac{1}{r} R'\Theta T + \frac{1}{r^2} R\Theta''T \right] = R\Theta T'.$$

Dividing both sides of the equation by the factor  $R\Theta T$ , we obtain

$$\frac{R''}{R} + \frac{1}{r} \frac{R'}{R} + \frac{1}{r^2} \frac{\Theta''}{\Theta} = \frac{T'}{\alpha^2 T}.$$

Since both sides of the resulting differential equation depend on *different* variables, each side must be equal to a constant, say  $-\lambda$ . That is,

$$\frac{R''}{R} + \frac{1}{r} \frac{R'}{R} + \frac{1}{r^2} \frac{\Theta''}{\Theta} = \frac{T'}{\alpha^2 T} = -\lambda^2.$$

It follows that  $T' + \alpha^2 \lambda^2 T = 0$ , and

$$\frac{R''}{R} + \frac{1}{r} \frac{R'}{R} + \frac{1}{r^2} \frac{\Theta''}{\Theta} = -\lambda^2.$$

Multiplying both sides of this differential equation by  $r^2$ , we find that

$$r^2 \frac{R''}{R} + r \frac{R'}{R} + \frac{\Theta''}{\Theta} = -\lambda^2 r^2,$$

which can be written as

$$r^2 \frac{R''}{R} + r \frac{R'}{R} + \lambda^2 r^2 = - \frac{\Theta''}{\Theta}.$$

Once again, since both sides of the resulting differential equation depend on *different* variables, each side must be equal to a constant. Hence

$$r^2 \frac{R''}{R} + r \frac{R'}{R} + \lambda^2 r^2 = \mu^2 \quad \text{and} \quad - \frac{\Theta''}{\Theta} = \mu^2.$$

The resulting ordinary equations are

$$\begin{aligned} r^2 R'' + rR' + (\lambda^2 r^2 - \mu^2)R &= 0 \\ \Theta'' + \mu^2 \Theta &= 0 \\ T' + \alpha^2 \lambda^2 T &= 0. \end{aligned}$$

## Section 10.6

1. The steady-state solution,  $v(x)$ , satisfies the boundary value problem

$$v''(x) = 0, \quad 0 < x < 50, \quad v(0) = 10, \quad v(50) = 40.$$

The general solution of the ODE is  $v(x) = Ax + B$ . Imposing the boundary conditions, we have

$$v(x) = \frac{40 - 10}{50}x + 10 = \frac{3x}{5} + 10.$$

2. The steady-state solution,  $v(x)$ , satisfies the boundary value problem

$$v''(x) = 0, \quad 0 < x < 40, \quad v(0) = 30, \quad v(40) = -20.$$

The solution of the ODE is *linear*. Imposing the boundary conditions, we have

$$v(x) = \frac{-20 - 30}{40}x + 30 = -\frac{5x}{4} + 30.$$

4. The steady-state solution is also a solution of the boundary value problem given by  $v''(x) = 0$ ,  $0 < x < L$ , and the conditions  $v'(0) = 0$ ,  $v(L) = T$ . The solution of the ODE is  $v(x) = Ax + B$ . The boundary condition  $v'(0) = 0$  requires that  $A = 0$ . The other condition requires that  $B = T$ . Hence  $v(x) = T$ .

5. As in Prob. 4, the steady-state solution has the form  $v(x) = Ax + B$ . The boundary condition  $v(0) = 0$  requires that  $B = 0$ . The boundary condition  $v'(L) = 0$  requires that  $A = 0$ . Hence  $v(x) = 0$ .

6. The steady-state solution has the form  $v(x) = Ax + B$ . The first boundary condition,  $v(0) = T$ , requires that  $B = T$ . The other boundary condition,  $v'(L) = 0$ , requires that  $A = 0$ . Hence  $v(x) = T$ .

8. The steady-state solution,  $v(x)$ , satisfies the differential equation  $v''(x) = 0$ , along with the boundary conditions

$$v(0) = T, \quad v'(L) + v(L) = 0.$$

The general solution of the ODE is  $v(x) = Ax + B$ . The boundary condition  $v'(0) = 0$  requires that  $B = T$ . It follows that  $v(x) = Ax + T$ , and

$$v'(L) + v(L) = A + AL + T.$$

The second boundary condition requires that  $A = -T/(1 + L)$ . Therefore

$$v(x) = -\frac{Tx}{1 + L} + T.$$



10(a). Based on the *symmetry* of the problem, consider only *left* half of the bar. The steady-state solution satisfies the ODE  $v''(x) = 0$ , along with the boundary conditions  $v(0) = 0$  and  $v(50) = 100$ . The solution of this boundary value problem is  $v(x) = 2x$ . It follows that the steady-state temperature is the *entire* rod is given by

$$f(x) = \begin{cases} 2x, & 0 \leq x \leq 50 \\ 200 - 2x, & 50 \leq x \leq 100. \end{cases}$$

(b). The heat conduction problem is formulated as

$$\begin{aligned} \alpha^2 u_{xx} &= u_t, & 0 < x < 100, & t > 0; \\ u(0, t) &= 20, & u(100, t) &= 0, & t > 0; \\ u(x, 0) &= f(x), & 0 < x < 100. \end{aligned}$$

First express the solution as  $u(x, t) = g(x) + w(x, t)$ , where  $g(x) = -x/5 + 20$  and  $w$  satisfies the heat conduction problem

$$\begin{aligned} \alpha^2 w_{xx} &= w_t, & 0 < x < 100, & t > 0; \\ w(0, t) &= 0, & w(100, t) &= 0, & t > 0; \\ w(x, 0) &= f(x) - g(x), & 0 < x < 100. \end{aligned}$$

Based on the results in Section 10.5,

$$w(x, t) = \sum_{n=1}^{\infty} c_n e^{-n^2 \pi^2 \alpha^2 t / 10000} \sin \frac{n \pi x}{100},$$

in which the coefficients  $c_n$  are the Fourier sine coefficients of  $f(x) - g(x)$ . That is,

$$\begin{aligned} c_n &= \frac{2}{L} \int_0^L [f(x) - g(x)] \sin \frac{n \pi x}{L} dx \\ &= \frac{1}{50} \int_0^{100} [f(x) - g(x)] \sin \frac{n \pi x}{100} dx \\ &= 40 \frac{20 \sin \frac{n \pi}{2} - n \pi}{n^2 \pi^2}. \end{aligned}$$

Finally, the *thermal diffusivity* of copper is  $1.14 \text{ cm}^2/\text{sec}$ . Therefore the temperature distribution in the rod is

$$u(x, t) = 20 - \frac{x}{5} + \frac{40}{\pi^2} \sum_{n=1}^{\infty} \frac{20 \sin \frac{n \pi}{2} - n \pi}{n^2} e^{-1.14 n^2 \pi^2 t / 10000} \sin \frac{n \pi x}{100}.$$

(c).  $t = 5, 10, 20, 40 \text{ sec}$  :

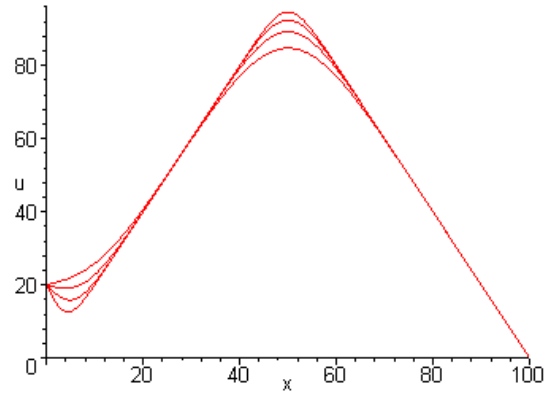

$t = 100, 200, 300, 500 \text{ sec}$  :

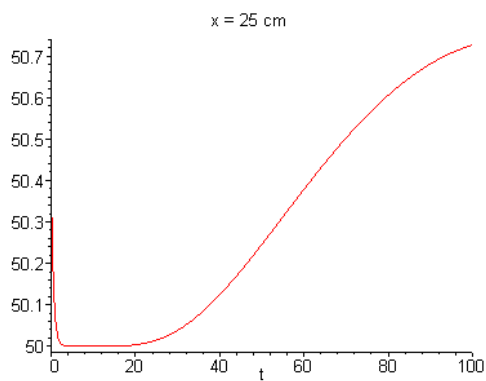
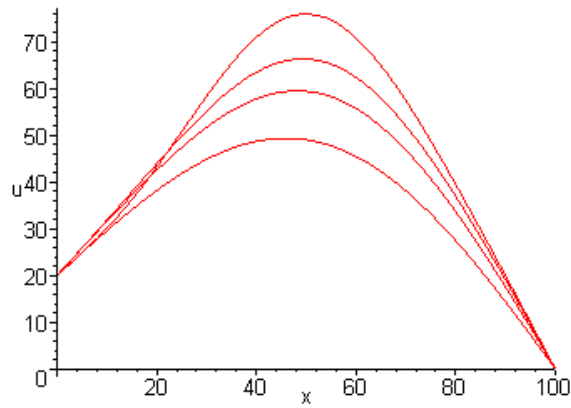

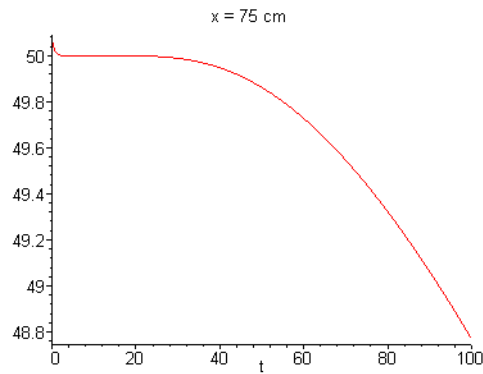
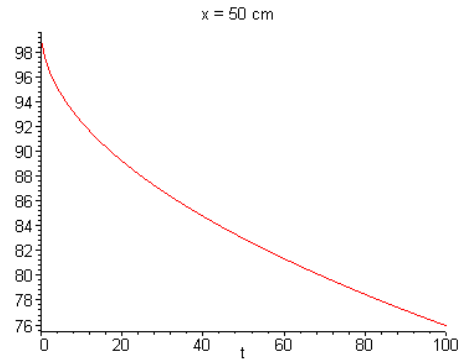

(d). The steady-state temperature of the center of the rod will be  $g(50) = 10^\circ C$ .

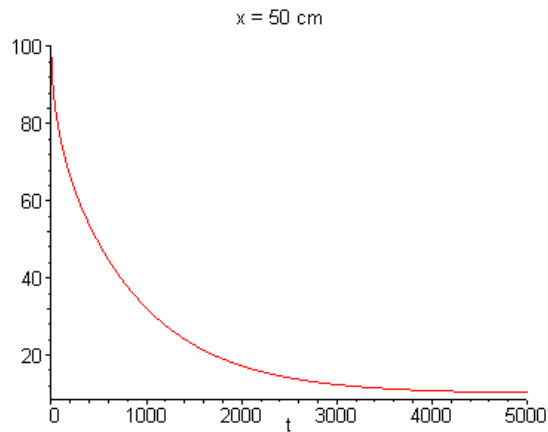

Using a one-term approximation,

$$u(x, t) \approx 10 + \frac{800 - 40\pi}{\pi^2} e^{-1.14\pi^2 t/10000}.$$

Numerical investigation shows that  $10 < u(50, t) < 11$  for  $t \geq 3755 \text{ sec}$ .

11(a). The heat conduction problem is formulated as

$$\begin{aligned} u_{xx} &= u_t, & 0 < x < 30, \quad t > 0; \\ u(0, t) &= 30, & u(30, t) &= 0, \quad t > 0; \\ u(x, 0) &= f(x), & 0 < x < 30, \end{aligned}$$

in which the initial condition is given by  $f(x) = x(60 - x)/30$ . Express the solution as  $u(x, t) = v(x) + w(x, t)$ , where  $v(x) = 30 - x$  and  $w$  satisfies the heat conduction problem

$$\begin{aligned} w_{xx} &= w_t, & 0 < x < 30, \quad t > 0; \\ w(0, t) &= 0, & w(30, t) &= 0, \quad t > 0; \\ w(x, 0) &= f(x) - v(x), & 0 < x < 30. \end{aligned}$$

As shown in Section 10.5,

$$w(x, t) = \sum_{n=1}^{\infty} c_n e^{-n^2\pi^2 t/900} \sin \frac{n\pi x}{30},$$

in which the coefficients  $c_n$  are the Fourier sine coefficients of  $f(x) - v(x)$ . That is,

$$\begin{aligned} c_n &= \frac{2}{L} \int_0^L [f(x) - g(x)] \sin \frac{n\pi x}{L} dx \\ &= \frac{1}{15} \int_0^{30} [f(x) - g(x)] \sin \frac{n\pi x}{30} dx \\ &= 60 \frac{2(1 - \cos n\pi) - n^2\pi^2(1 + \cos n\pi)}{n^3\pi^3}. \end{aligned}$$

Therefore the temperature distribution in the rod is

$$u(x, t) = 30 - x + \frac{60}{\pi^3} \sum_{n=1}^{\infty} \frac{2(1 - \cos n\pi) - n^2\pi^2(1 + \cos n\pi)}{n^3} e^{-n^2\pi^2 t/900} \sin \frac{n\pi x}{30}.$$

(b).  $t = 5, 10, 20, 40 \text{ sec}$  :

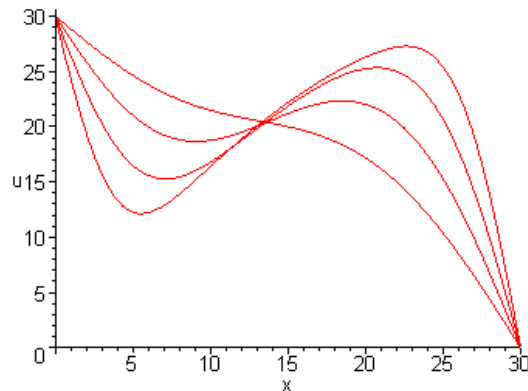

$t = 50, 75, 100, 200 \text{ sec}$  :

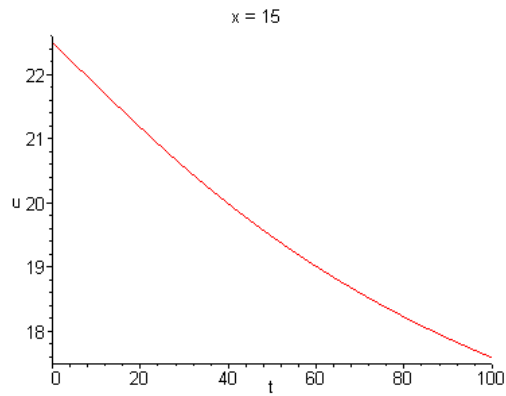
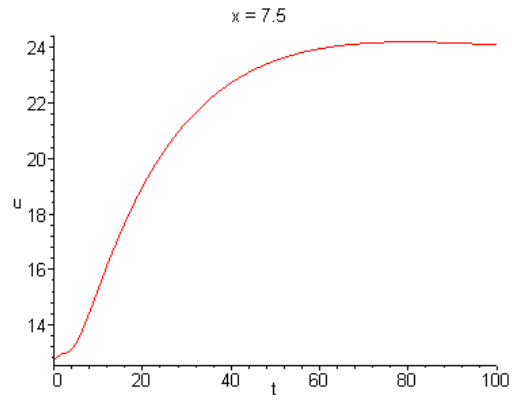
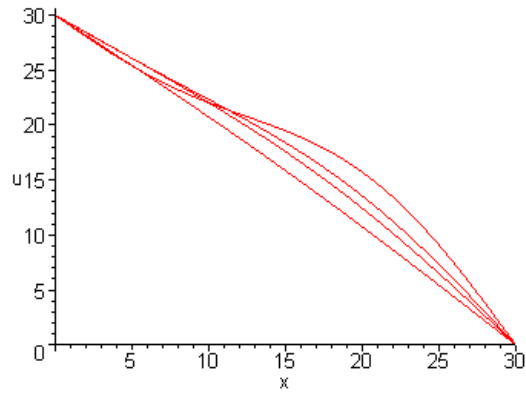

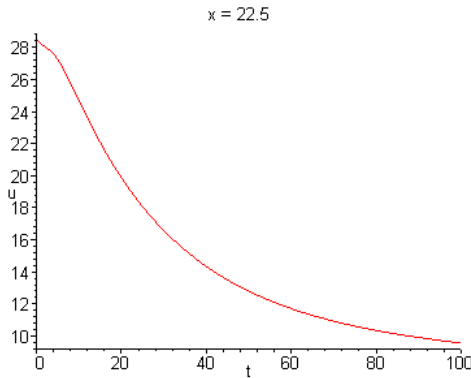

(c).

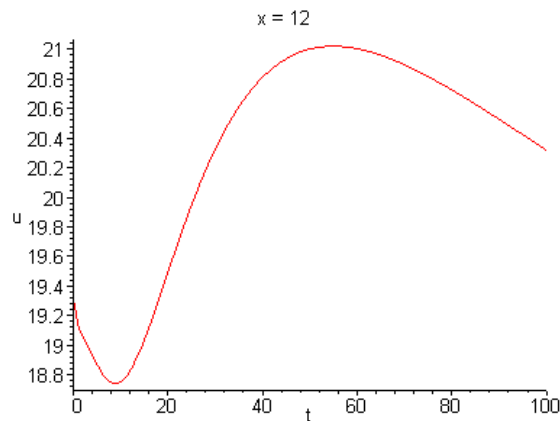

Based on the *heat conduction equation*, the rate of change of the temperature at any given point is proportional to the *concavity* of the graph of  $u$  versus  $x$ , that is,  $u_{xx}$ . Evidently, near  $t = 60$ , the concavity of  $u(x, t)$  changes.

13(a). The heat conduction problem is formulated as

$$\begin{aligned} u_{xx} &= 4u_t, & 0 < x < 40, t > 0; \\ u_x(0, t) &= 0, & u_x(40, t) &= 0, t > 0; \\ u(x, 0) &= f(x), & 0 < x < 40, \end{aligned}$$

in which the initial condition is given by  $f(x) = x(60 - x)/30$ .

As shown in the discussion on rods with *insulated ends*, the solution is given by

$$u(x, t) = \frac{c_0}{2} + \sum_{n=1}^{\infty} c_n e^{-n^2\pi^2\alpha^2t/1600} \cos \frac{n\pi x}{40},$$

where  $c_n$  are the Fourier cosine coefficients. In this problem,

$$\begin{aligned}
 c_0 &= \frac{2}{L} \int_0^L f(x) dx \\
 &= \frac{1}{20} \int_0^{40} \frac{x(60-x)}{30} dx \\
 &= 400/9,
 \end{aligned}$$

and for  $n \geq 1$ ,

$$\begin{aligned}
 c_n &= \frac{2}{L} \int_0^L f(x) \cos \frac{n\pi x}{L} dx \\
 &= \frac{1}{20} \int_0^{40} \frac{x(60-x)}{30} \cos \frac{n\pi x}{40} dx \\
 &= -\frac{160(3 + \cos n\pi)}{3n^2\pi^2}.
 \end{aligned}$$

Therefore the temperature distribution in the rod is

$$u(x, t) = \frac{200}{9} - \frac{160}{3\pi^2} \sum_{n=1}^{\infty} \frac{(3 + \cos n\pi)}{n^2} e^{-n^2\pi^2 t/6400} \cos \frac{n\pi x}{40}.$$

(b).  $t = 50, 100, 150, 200$  sec :

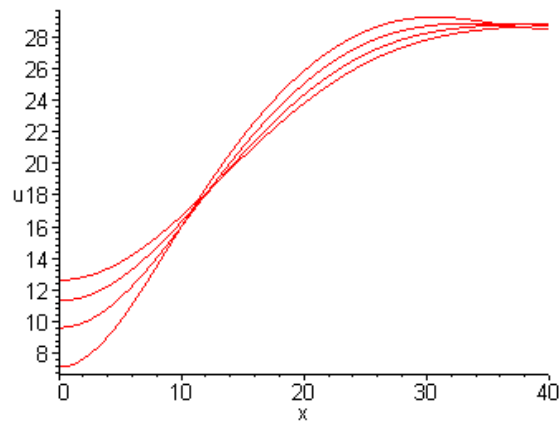

$t = 40, 600, 800, 1000 \text{ sec}$  :

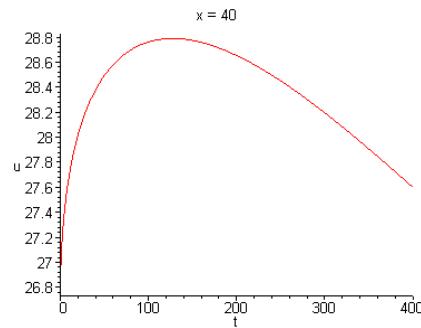
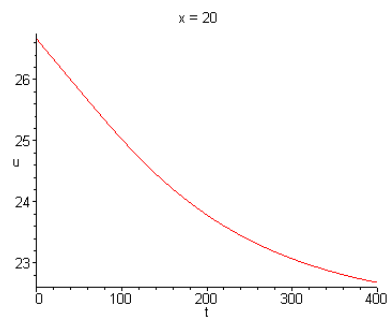
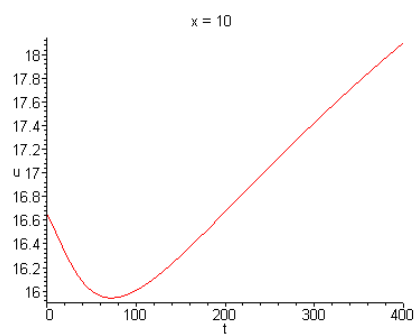
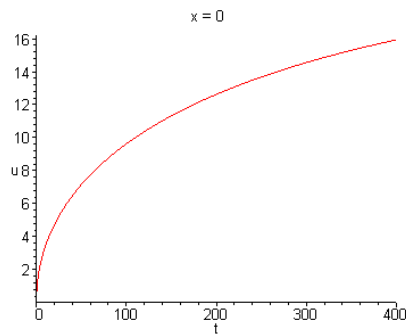
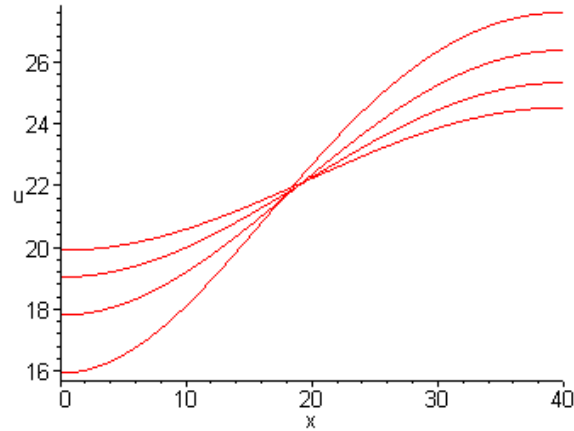

(c). Since

$$\lim_{t \rightarrow \infty} e^{-n^2\pi^2t/6400} \cos \frac{n\pi x}{40} = 0$$

for each  $x$ , it follows that the steady-state temperature is  $u_\infty = 200/9$ .



(d). We first note that

$$u(40, t) = \frac{200}{9} - \frac{160}{3\pi^2} \sum_{n=1}^{\infty} \frac{(-1)^n (3 + \cos n\pi)}{n^2} e^{-n^2\pi^2 t/6400}.$$

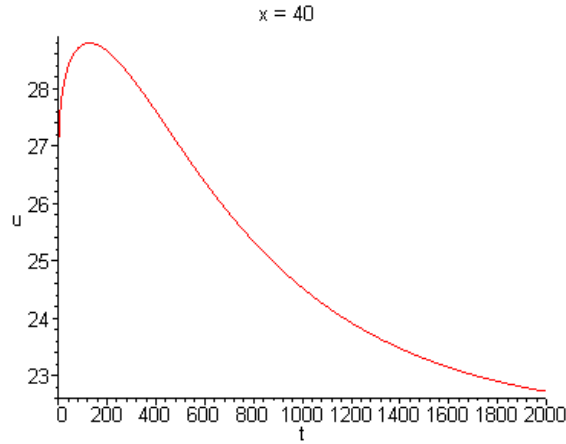

For large values of  $t$ , an approximation is given by

$$u(40, t) \approx \frac{200}{9} + \frac{320}{3\pi^2} e^{-\pi^2 t/6400}.$$

Numerical investigation shows that  $22.22 < u(40, t) < 23.22$  for  $t \geq 1550$  sec.

16(a). The heat conduction problem is formulated as

$$\begin{aligned} u_{xx} &= u_t, & 0 < x < 30, & t > 0; \\ u(0, t) &= 0, & u_x(30, t) &= 0, & t > 0; \\ u(x, 0) &= f(x), & 0 < x < 30, & \end{aligned}$$

in which the initial condition is given by  $f(x) = 30 - x$ . Based on the results of Prob. 15,

the solution is given by

$$u(x, t) = \sum_{n=1}^{\infty} c_n e^{-(2n-1)^2\pi^2 t/3600} \sin \frac{n\pi x}{60},$$

in which

$$\begin{aligned} c_n &= \frac{2}{L} \int_0^L f(x) \sin \frac{(2n-1)\pi x}{60} dx \\ &= \frac{1}{15} \int_0^{30} (30-x) \sin \frac{(2n-1)\pi x}{60} dx \\ &= 120 \frac{2 \cos n\pi + (2n-1)\pi}{(2n-1)^2 \pi^2}. \end{aligned}$$

Therefore the solution of the heat conduction problem is

$$u(x, t) = 120 \sum_{n=1}^{\infty} \frac{2 \cos n\pi + (2n - 1)\pi}{(2n - 1)^2 \pi^2} e^{-(2n-1)^2 \pi^2 t / 3600} \sin \frac{n\pi x}{60} .$$

(b).  $t = 10, 20, 30, 40 \text{ sec} :$

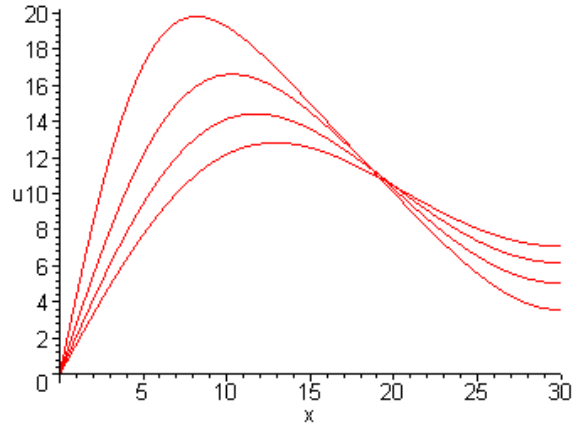

$t = 40, 60, 80, 100 \text{ sec} :$

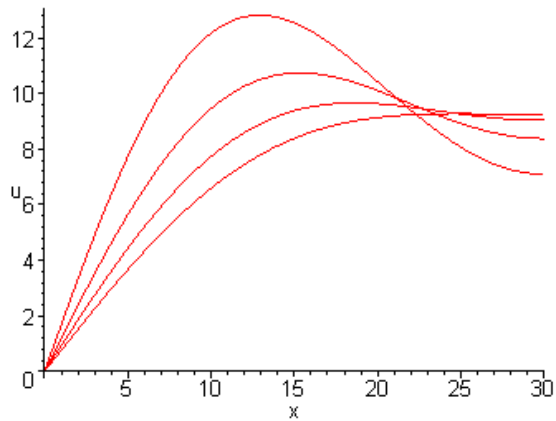

$t = 100, 150, 200, 250 \text{ sec}$  :

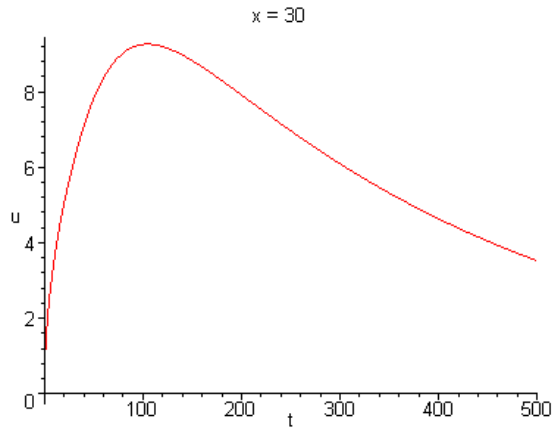
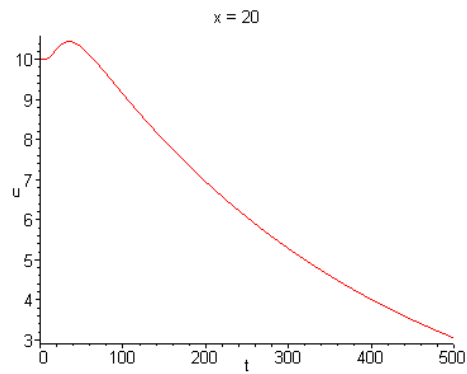
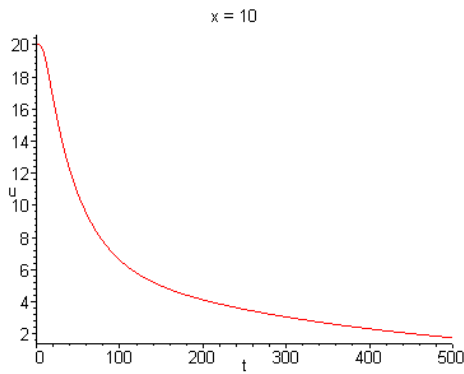
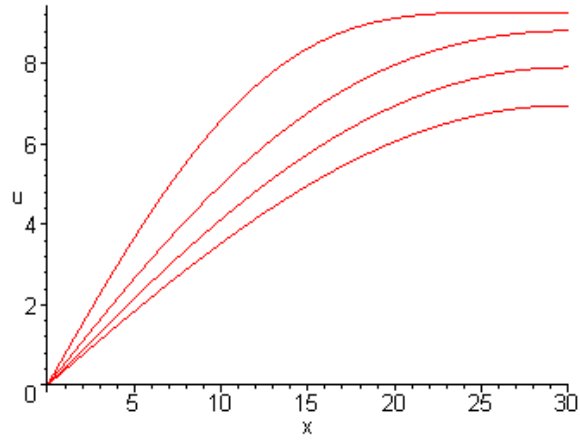

(c).

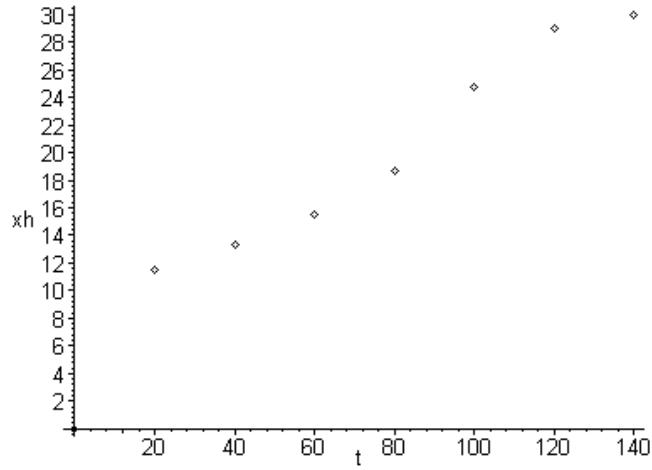

The location of  $x_h$  moves from  $x = 0$  to  $x = 30$ .

(d).

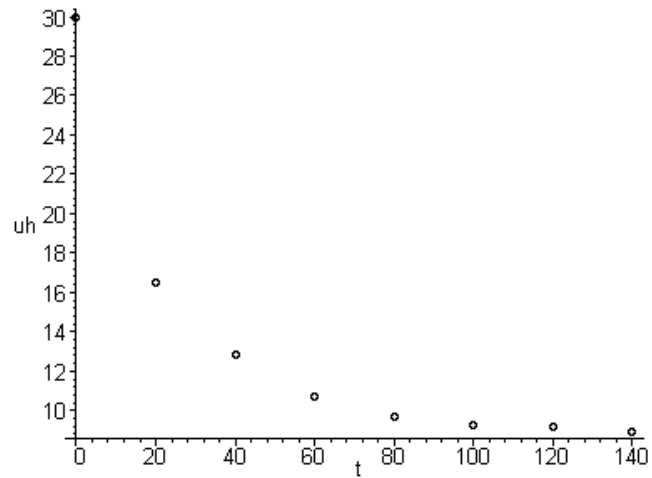

17(a). The heat conduction problem is formulated as

$$\begin{aligned} u_{xx} &= u_t, & 0 < x < 30, t > 0; \\ u(0, t) &= 40, & u_x(30, t) = 0, t > 0; \\ u(x, 0) &= 30 - x, & 0 < x < 30, \end{aligned}$$

The steady-state temperature satisfies the boundary value problem

$$v'' = 0, v(0) = 40 \text{ and } v'(30) = 0.$$

It easy to see we must have  $v(x) = 40$ . Express the solution as

$$u(x, t) = 40 + w(x, t),$$

in which  $w$  satisfies the heat conduction problem

$$\begin{aligned} w_{xx} &= w_t, & 0 < x < 30, \quad t > 0; \\ w(0, t) &= 0, & w_x(30, t) &= 0, \quad t > 0; \\ w(x, 0) &= -10 - x, & 0 < x < 30. \end{aligned}$$

As shown in Prob. 15, the solution is given by

$$w(x, t) = \sum_{n=1}^{\infty} c_n e^{-(2n-1)^2 \pi^2 t / 3600} \sin \frac{n\pi x}{60},$$

in which

$$\begin{aligned} c_n &= \frac{2}{L} \int_0^L f(x) \sin \frac{(2n-1)\pi x}{60} dx \\ &= \frac{1}{15} \int_0^{30} (-10 - x) \sin \frac{(2n-1)\pi x}{60} dx \\ &= 40 \frac{6 \cos n\pi - (2n-1)\pi}{(2n-1)^2 \pi^2}. \end{aligned}$$

Therefore the solution of the *original* heat conduction problem is

$$u(x, t) = 40 + 40 \sum_{n=1}^{\infty} \frac{6 \cos n\pi - (2n-1)\pi}{(2n-1)^2 \pi^2} e^{-(2n-1)^2 \pi^2 t / 3600} \sin \frac{n\pi x}{60}.$$

(b).  $t = 10, 30, 50, 70 \text{ sec}$  :

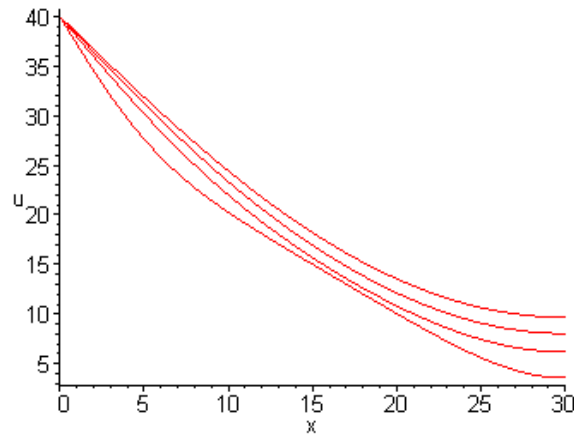

$t = 100, 200, 300, 400 \text{ sec} :$

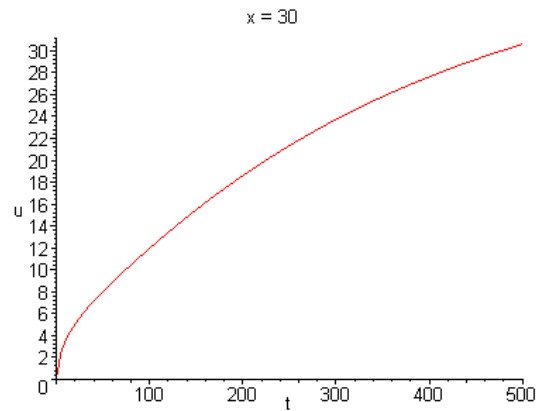
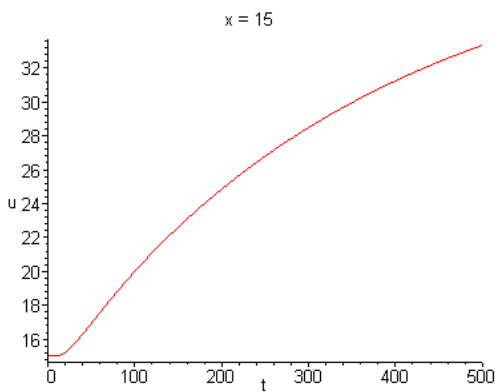
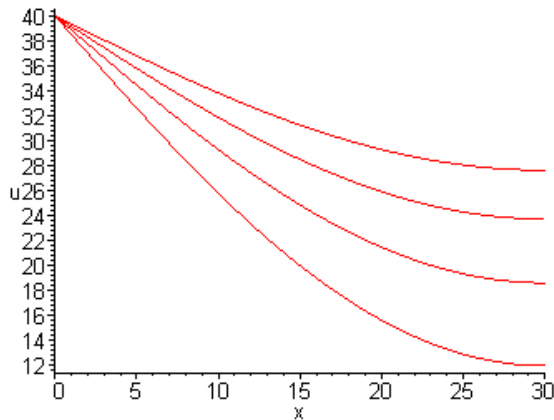

(c). Observe the concavity of the curves. Note also that the temperature at the *insulated* end tends to the value of the fixed temperature at the boundary  $x = 0$ .

18. Setting  $\lambda = \mu^2$ , the general solution of the ODE  $X'' + \mu^2 X = 0$  is

$$X(x) = k_1 e^{i\mu x} + k_2 e^{-i\mu x}.$$

The boundary conditions  $y'(0) = y'(L) = 0$  lead to the system of equations

$$\begin{aligned} \mu k_1 - \mu k_2 &= 0 \\ \mu k_1 e^{i\mu L} - \mu k_2 e^{-i\mu L} &= 0. \end{aligned} \tag{*}$$

If  $\mu = 0$ , then the solution of the ODE is  $X = Ax + B$ . The boundary conditions require that  $X = B$ .

If  $\mu \neq 0$ , then the system algebraic equations has a *nontrivial* solution if and only if the coefficient matrix is *singular*. Set the determinant equal to zero to obtain

$$e^{-i\mu L} - e^{i\mu L} = 0.$$

Let  $\mu = \nu + i\sigma$ . Then  $i\mu L = i\nu L - \sigma L$ , and the previous equation can be written as

$$e^{\sigma L} e^{-i\nu L} - e^{-\sigma L} e^{i\nu L} = 0.$$

Using Euler's relation,  $e^{i\nu L} = \cos \nu L + i \sin \nu L$ , we obtain

$$e^{\sigma L}(\cos \nu - i \sin \nu) - e^{-\sigma L}(\cos \nu + i \sin \nu) = 0.$$

Equating the real and imaginary parts of the equation,

$$\begin{aligned} (e^{\sigma L} - e^{-\sigma L}) \cos \nu L &= 0 \\ (e^{\sigma L} + e^{-\sigma L}) \sin \nu L &= 0. \end{aligned}$$

Based on the second equation,  $\nu L = n\pi$ ,  $n \in \mathbb{I}$ . Since  $\cos nL \neq 0$ , it follows that  $e^{\sigma L} = e^{-\sigma L}$ , or  $e^{2\sigma L} = 1$ . Hence  $\sigma = 0$ , and  $\mu = n\pi/L$ ,  $n \in \mathbb{I}$ .

Note that if  $\sigma \neq 0$ , then the last two equations have no solution. It follows that the system of equations (\*) has *no nontrivial solutions*.

20(a). Consider solutions of the form  $u(x, t) = X(x)T(t)$ . Substitution into the partial differential equation results in

$$\alpha^2 X'' T = T'.$$

Divide both sides of the differential equation by the product  $XT$  to obtain

$$\frac{X''}{X} = \frac{T'}{\alpha^2 T}.$$

Since both sides of the resulting equation are functions of different variables, each must be equal to a constant, say  $-\lambda$ . We obtain the ordinary differential equations

$$X'' + \lambda X = 0 \text{ and } T' + \lambda \alpha^2 T = 0.$$

Invoking the first boundary condition,

$$u(0, t) = X(0)T(t) = 0.$$

At the other boundary,

$$u_x(L, t) + \gamma u(L, t) = [X'(L) + \gamma X(L)]T(t) = 0.$$

Since these conditions are valid for all  $t > 0$ , it follows that

$$X(0) = 0 \text{ and } X'(L) + \gamma X(L) = 0.$$

(b). We consider the boundary value problem

$$\begin{aligned} X'' + \lambda X &= 0, \quad 0 < x < L; \\ X(0) &= 0, \quad X'(L) + \gamma X(L) = 0. \end{aligned} \quad (*)$$

Assume that  $\lambda$  is real, with  $\lambda = -\mu^2$ . The general solution of the ODE is

$$X(x) = c_1 \cosh(\mu x) + c_2 \sinh(\mu x).$$

The first boundary condition requires that  $c_1 = 0$ . Imposing the second boundary condition,

$$c_2 \mu \cosh(\mu L) + \gamma c_2 \sinh(\mu L) = 0.$$

If  $c_2 \neq 0$ , then  $\mu \cosh(\mu L) + \gamma \sinh(\mu L) = 0$ , which can also be written as

$$(\mu + \gamma)e^{\mu L} - (\mu - \gamma)e^{-\mu L} = 0.$$

If  $\gamma = -\mu$ , then it follows that  $\cosh(\mu L) = \sinh(\mu L)$ , and hence  $\mu = 0$ . If  $\gamma \neq -\mu$ , then  $e^{\mu L} = e^{-\mu L}$  again implies that  $\mu = 0$ . For the case  $\mu = 0$ , the general solution is  $X(x) = Ax + B$ . Imposing the boundary conditions, we have  $B = 0$  and

$$A + \gamma AL = 0.$$

If  $\gamma = -1/L$ , then  $X(x) = Ax$  is a solution of (\*). Otherwise  $A = 0$ .

(c). Let  $\lambda = \mu^2$ , with  $\mu > 0$ . The general solution of (\*) is

$$X(x) = c_1 \cos(\mu x) + c_2 \sin(\mu x).$$

The first boundary condition requires that  $c_1 = 0$ . From the second boundary condition,

$$c_2 \mu \cos(\mu L) + \gamma c_2 \sin(\mu L) = 0.$$

For a nontrivial solution, we must have

$$\mu \cos(\mu L) + \gamma \sin(\mu L) = 0.$$

(d). The last equation can also be written as

$$\tan \mu L = -\frac{\mu}{\gamma}. \quad (**)$$

The eigenvalues  $\lambda$  obtained from the solutions of (\*\*), which are *infinite* in number. In the graph below, we assume  $\gamma L = 1$ .



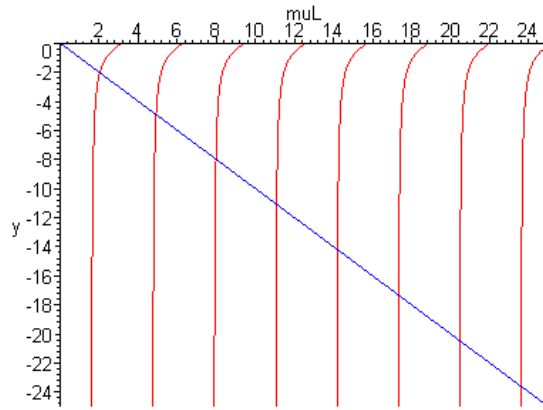

For  $\gamma L = -1$  :

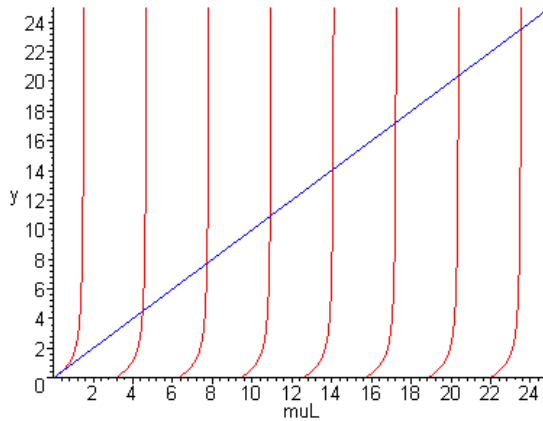

Denote the nonzero solutions of  $(**)$  by  $\mu_1, \mu_2, \mu_3, \dots$ .

(e). We can in principle calculate the eigenvalues  $\lambda_n = \mu_n^2$ . Hence the associated eigenfunctions are  $X_n = \sin \mu_n x$ . Furthermore, the solutions of the temporal equations are  $T_n = \exp(-\alpha^2 \mu_n^2 t)$ . The fundamental solutions of the heat conduction problem are given as

$$u_n(x, t) = e^{-\alpha^2 \mu_n^2 t} \sin \mu_n x,$$

which lead to the general solution

$$u(x, t) = \sum_{n=1}^{\infty} c_n e^{-\alpha^2 \mu_n^2 t} \sin \mu_n x.$$

**Section 10.7**

2(a). The initial velocity is *zero*. Therefore the solution, as given by Eq. (20), is

$$u(x, t) = \sum_{n=1}^{\infty} c_n \sin \frac{n\pi x}{L} \cos \frac{n\pi a t}{L},$$

in which the coefficients are the Fourier *sine* coefficients of  $f(x)$ . That is,

$$\begin{aligned} c_n &= \frac{2}{L} \int_0^L f(x) \sin \frac{n\pi x}{L} dx \\ &= \frac{2}{L} \left[ \int_0^{L/4} \frac{4x}{L} \sin \frac{n\pi x}{L} dx + \int_{L/4}^{3L/4} \sin \frac{n\pi x}{L} dx + \int_{3L/4}^L \frac{4L-4x}{L} \sin \frac{n\pi x}{L} dx \right] \\ &= 8 \frac{\sin n\pi/4 + \sin 3n\pi/4}{n^2\pi^2}. \end{aligned}$$

Therefore the displacement of the string is given by

$$u(x, t) = \frac{8}{\pi^2} \sum_{n=1}^{\infty} \left[ \sin \frac{n\pi}{4} + \sin \frac{3n\pi}{4} \right] \sin \frac{n\pi x}{L} \cos \frac{n\pi a t}{L}.$$

(b). With  $a = 1$  and  $L = 10$ ,

$$u(x, t) = \frac{8}{\pi^2} \sum_{n=1}^{\infty} \left[ \sin \frac{n\pi}{4} + \sin \frac{3n\pi}{4} \right] \sin \frac{n\pi x}{10} \cos \frac{n\pi t}{10}.$$

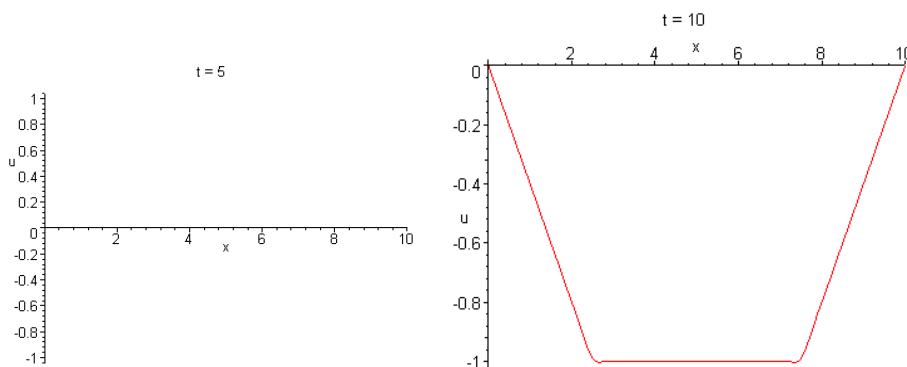

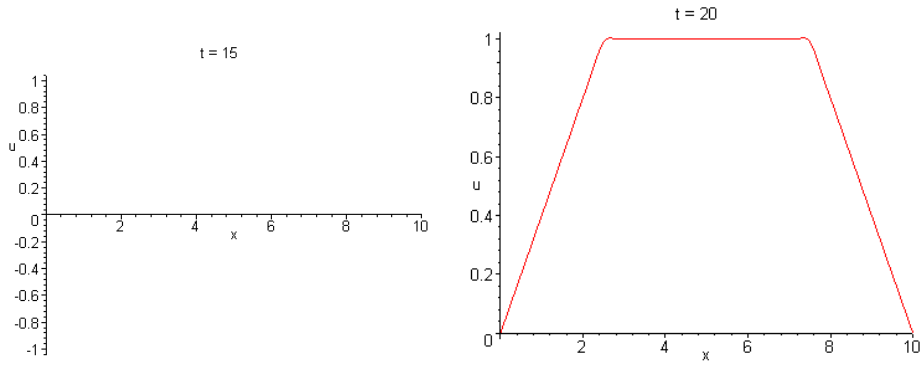

(c).

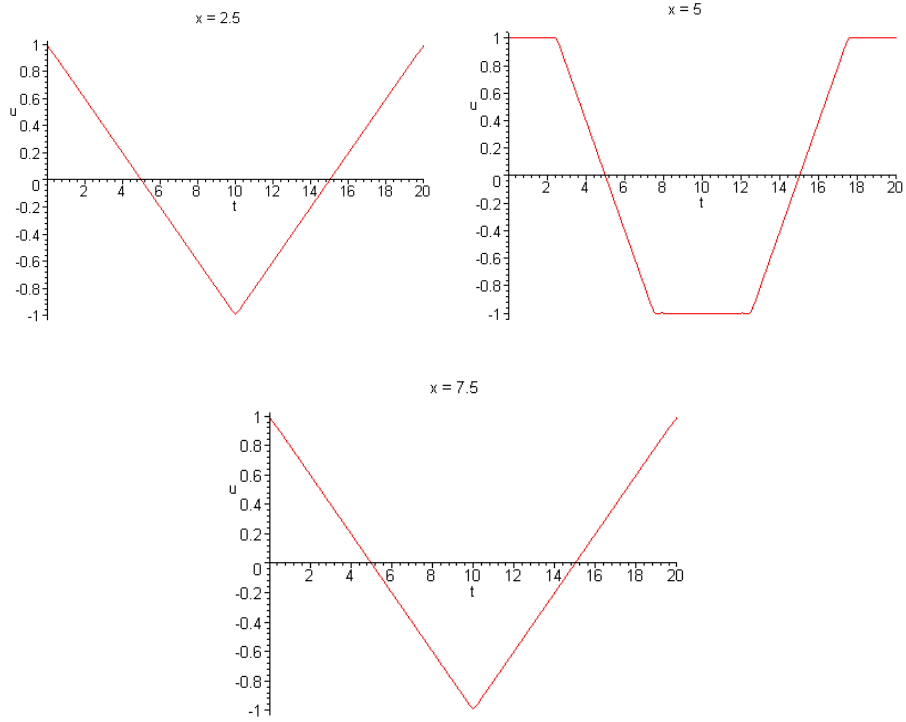

(d).

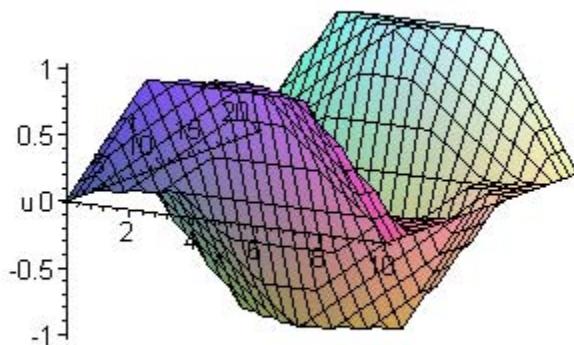
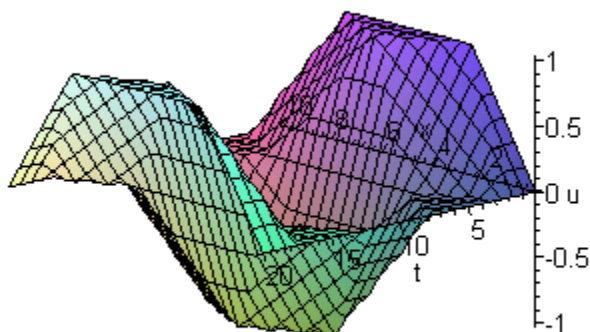

3(a). The initial velocity is *zero*. As given by Eq. (20), the solution is

$$u(x, t) = \sum_{n=1}^{\infty} c_n \sin \frac{n\pi x}{L} \cos \frac{n\pi a t}{L},$$

in which the coefficients are the Fourier *sine* coefficients of  $f(x)$ . That is,

$$\begin{aligned}
 c_n &= \frac{2}{L} \int_0^L f(x) \sin \frac{n\pi x}{L} dx \\
 &= \frac{2}{L} \int_0^L \frac{8x(L-x)^2}{L^3} \sin \frac{n\pi x}{L} dx \\
 &= 32 \frac{2 + \cos n\pi}{n^3 \pi^3}.
 \end{aligned}$$

Therefore the displacement of the string is given by

$$u(x, t) = \frac{32}{\pi^3} \sum_{n=1}^{\infty} \frac{2 + \cos n\pi}{n^3} \sin \frac{n\pi x}{L} \cos \frac{n\pi a t}{L}.$$

(b). With  $a = 1$  and  $L = 10$ ,

$$u(x, t) = \frac{32}{\pi^3} \sum_{n=1}^{\infty} \frac{2 + \cos n\pi}{n^3} \sin \frac{n\pi x}{10} \cos \frac{n\pi t}{10}.$$

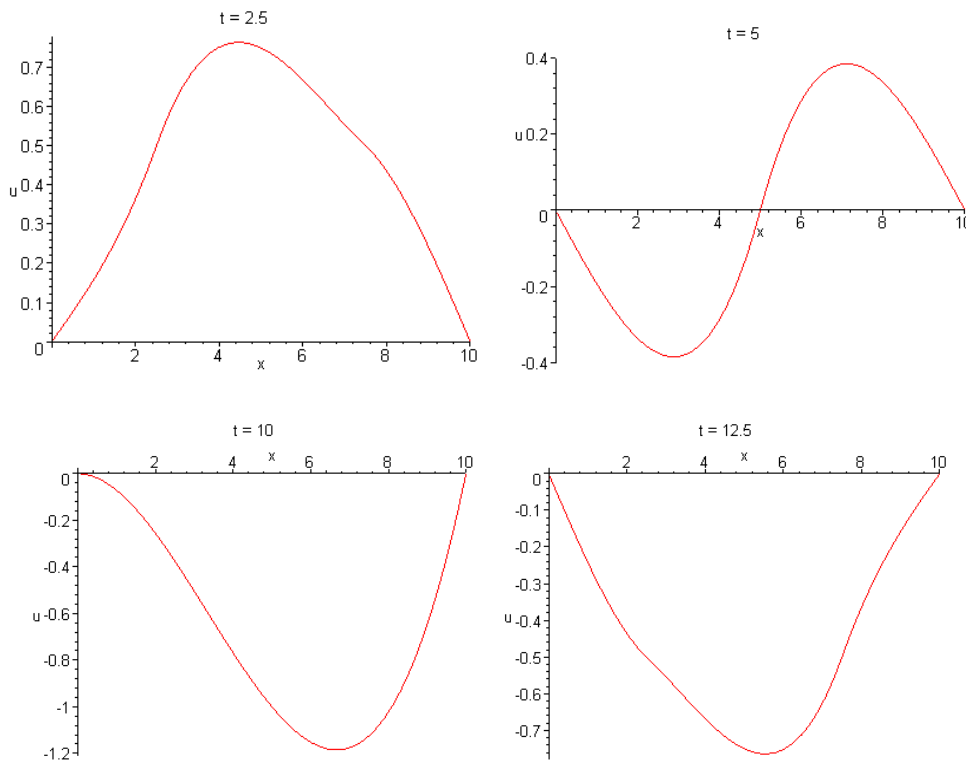

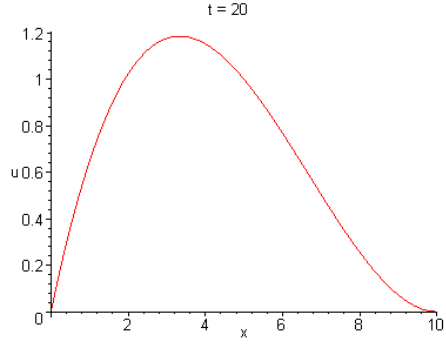
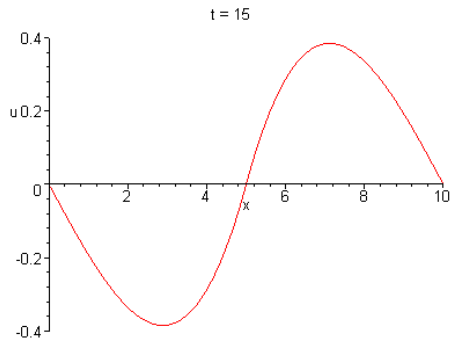

(c).

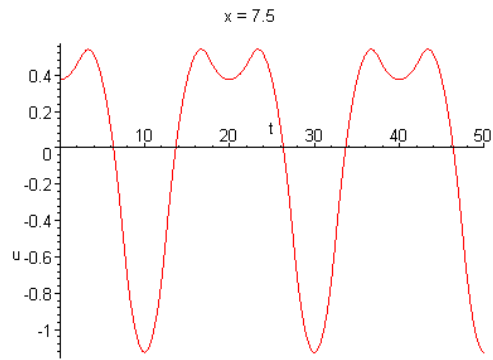
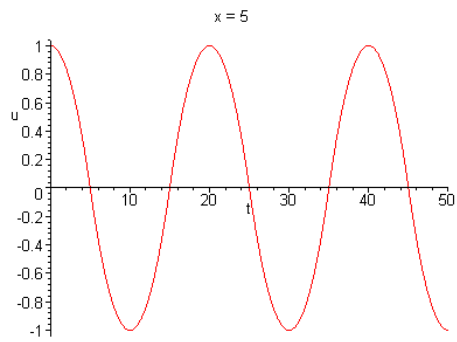
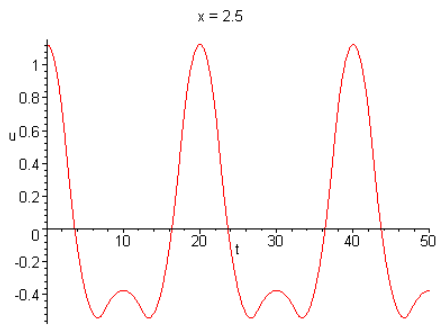

(d).

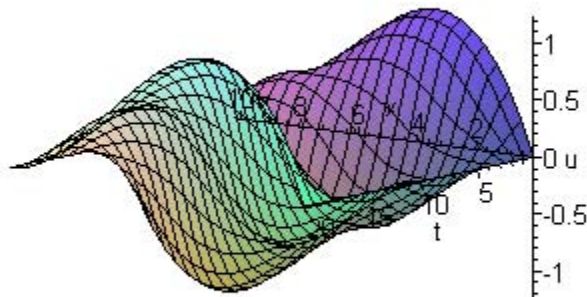
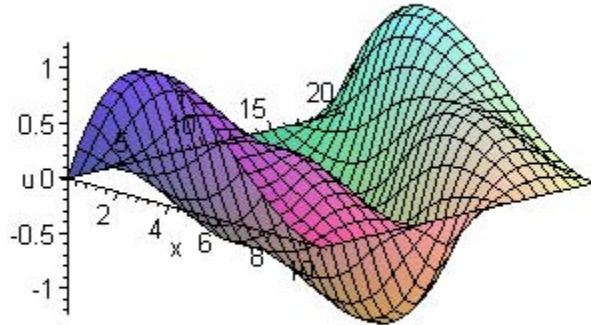

4(a). As given by Eq. (20), the solution is

$$u(x, t) = \sum_{n=1}^{\infty} c_n \sin \frac{n\pi x}{L} \cos \frac{n\pi a t}{L},$$

in which the coefficients are the Fourier *sine* coefficients of  $f(x)$ . That is,

$$\begin{aligned}
 c_n &= \frac{2}{L} \int_0^L f(x) \sin \frac{n\pi x}{L} dx \\
 &= \frac{2}{L} \int_{L/2-1}^{L/2+1} \sin \frac{n\pi x}{L} dx \\
 &= 4 \frac{\sin \frac{n\pi}{2} \sin \frac{n\pi}{L}}{n\pi}.
 \end{aligned}$$

Therefore the displacement of the string is given by

$$u(x, t) = \frac{4}{\pi} \sum_{n=1}^{\infty} \frac{1}{n} \left[ \sin \frac{n\pi}{2} \sin \frac{n\pi}{L} \right] \sin \frac{n\pi x}{L} \cos \frac{n\pi a t}{L}.$$

(b). With  $a = 1$  and  $L = 10$ ,

$$u(x, t) = \frac{4}{\pi} \sum_{n=1}^{\infty} \frac{1}{n} \left[ \sin \frac{n\pi}{2} \sin \frac{n\pi}{10} \right] \sin \frac{n\pi x}{10} \cos \frac{n\pi t}{10}.$$

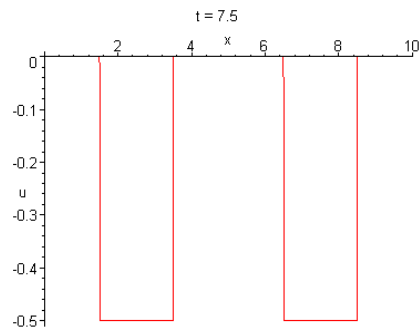
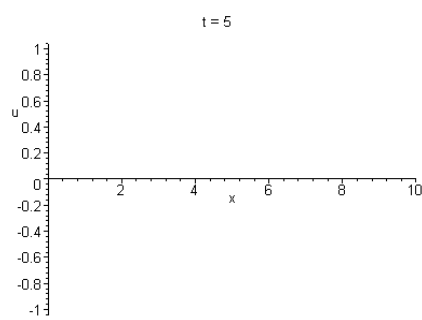
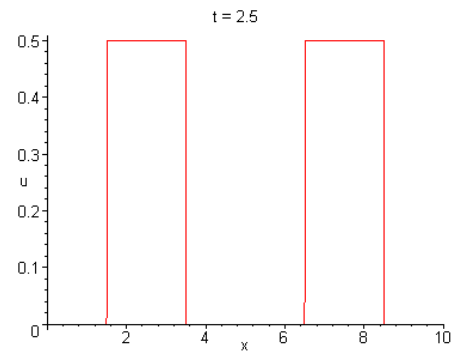
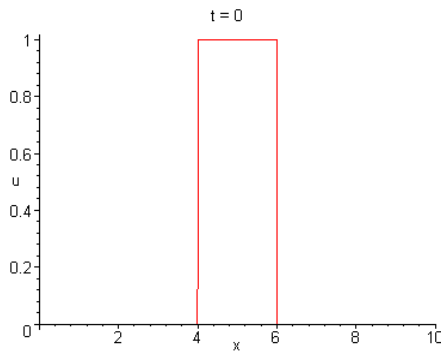



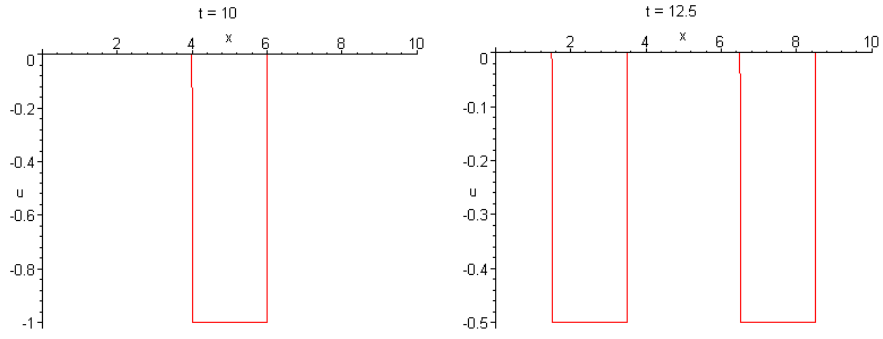

(c).

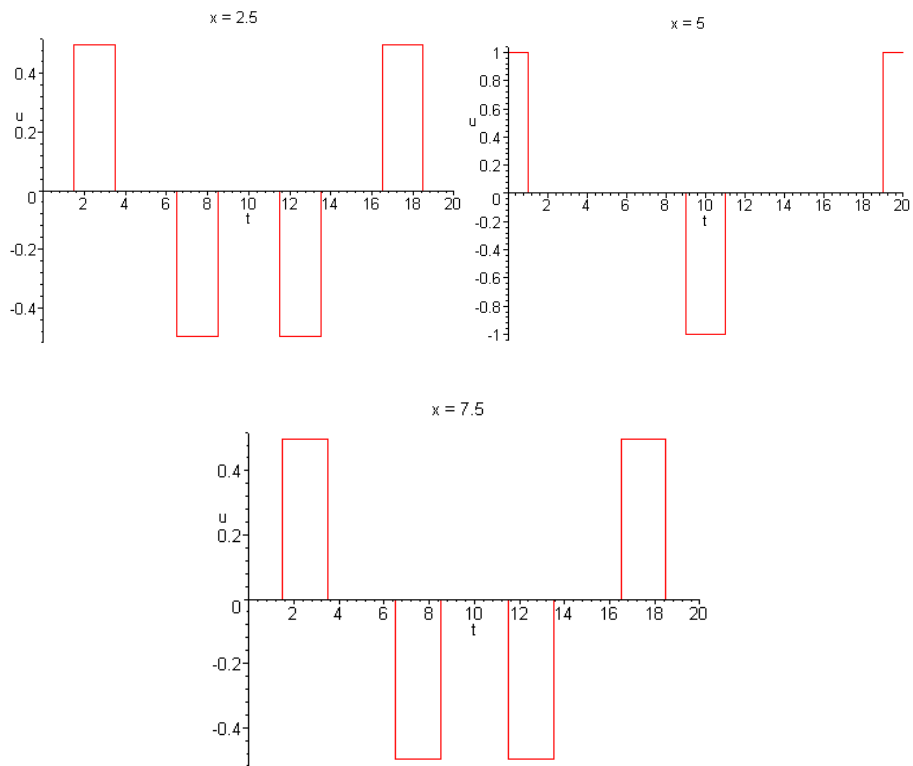

(d).

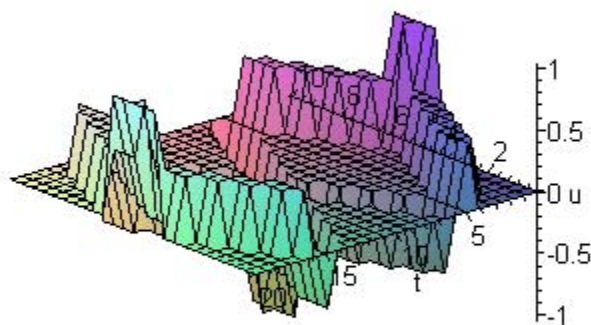
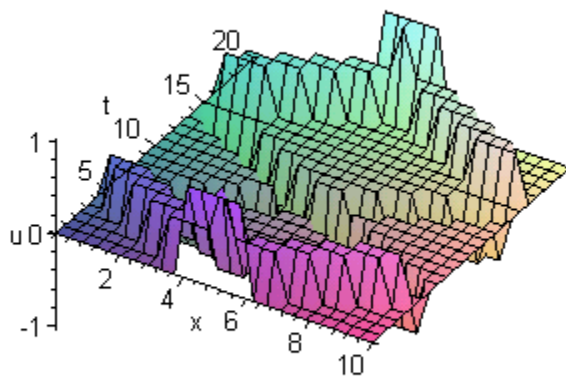

5(a). The initial displacement is *zero*. Therefore the solution, as given by Eq. (34), is

$$u(x, t) = \sum_{n=1}^{\infty} k_n \sin \frac{n\pi x}{L} \sin \frac{n\pi a t}{L},$$

in which the coefficients are the Fourier *sine* coefficients of  $u_t(x, 0) = g(x)$ . It follows that

$$\begin{aligned}
 k_n &= \frac{2}{n\pi a} \int_0^L g(x) \sin \frac{n\pi x}{L} dx \\
 &= \frac{2}{n\pi a} \left[ \int_0^{L/2} \frac{2x}{L} \sin \frac{n\pi x}{L} dx + \int_{L/2}^L \frac{2(L-x)}{L} \sin \frac{n\pi x}{L} dx \right] \\
 &= 8L \frac{\sin n\pi/2}{n^3\pi^3 a}.
 \end{aligned}$$

Therefore the displacement of the string is given by

$$u(x, t) = \frac{8L}{a\pi^3} \sum_{n=1}^{\infty} \frac{1}{n^3} \sin \frac{n\pi}{2} \sin \frac{n\pi x}{L} \sin \frac{n\pi a t}{L}.$$

(b). With  $a = 1$  and  $L = 10$ ,

$$u(x, t) = \frac{80}{\pi^3} \sum_{n=1}^{\infty} \frac{1}{n^3} \sin \frac{n\pi}{2} \sin \frac{n\pi x}{10} \sin \frac{n\pi t}{10}.$$

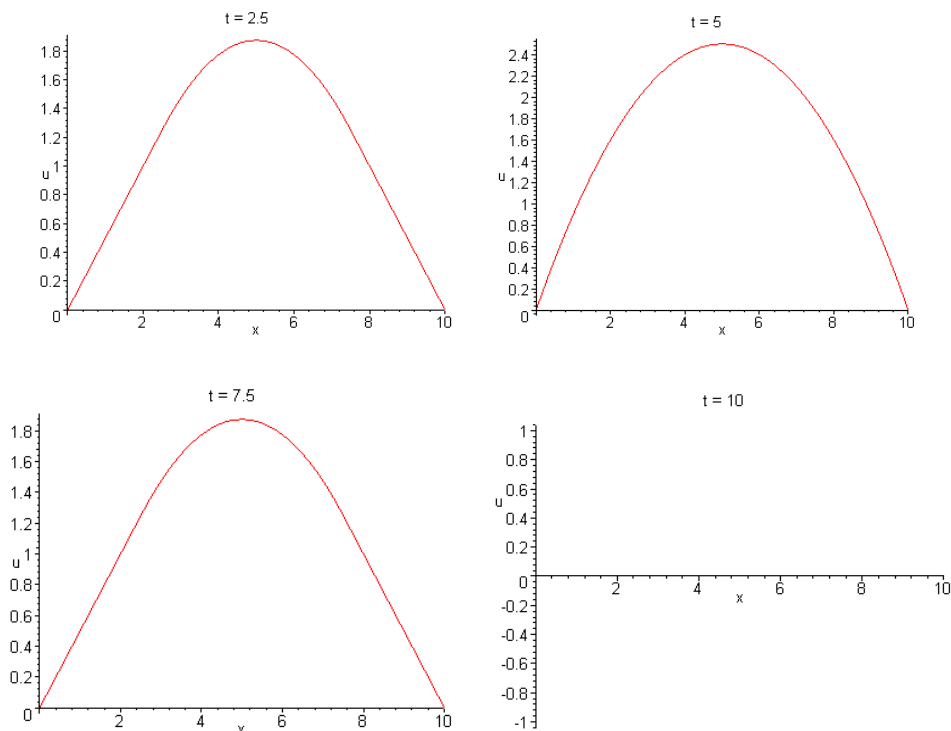

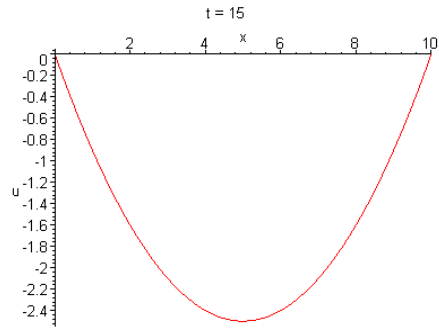
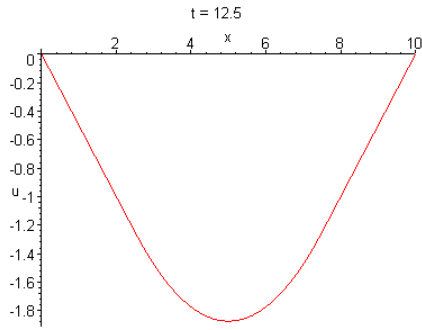

(c).

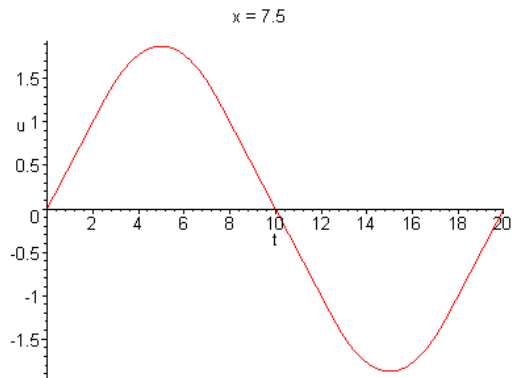
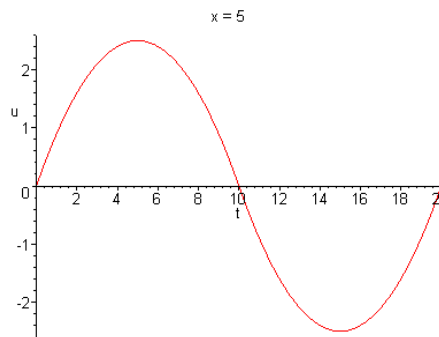
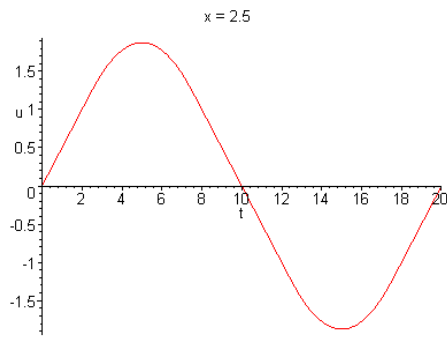

(d).

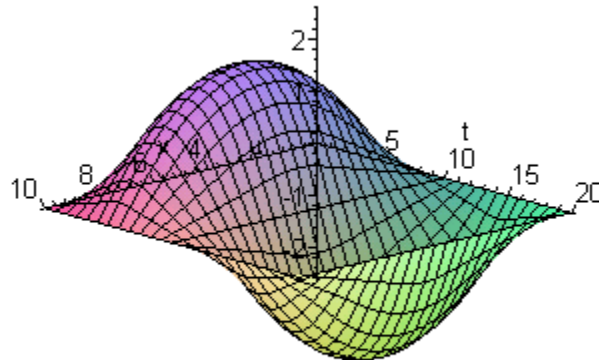
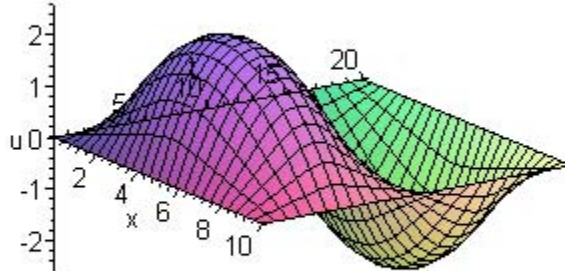

7(a). The initial displacement is *zero*. As given by Eq. (34), the solution is

$$u(x, t) = \sum_{n=1}^{\infty} k_n \sin \frac{n\pi x}{L} \sin \frac{n\pi a t}{L},$$

in which the coefficients are the Fourier *sine* coefficients of  $u_t(x, 0) = g(x)$ . It follows

that

$$\begin{aligned} k_n &= \frac{2}{n\pi a} \int_0^L g(x) \sin \frac{n\pi x}{L} dx \\ &= \frac{2}{n\pi a} \int_0^L \frac{8x(L-x)^2}{L^3} \sin \frac{n\pi x}{L} dx \\ &= 32L \frac{2 + \cos n\pi}{n^4 \pi^4 a}. \end{aligned}$$

Therefore the displacement of the string is given by

$$u(x, t) = \frac{32L}{a\pi^4} \sum_{n=1}^{\infty} \frac{2 + \cos n\pi}{n^4} \sin \frac{n\pi x}{L} \sin \frac{n\pi a t}{L}.$$

(b). With  $a = 1$  and  $L = 10$ ,

$$u(x, t) = \frac{320}{\pi^4} \sum_{n=1}^{\infty} \frac{2 + \cos n\pi}{n^4} \sin \frac{n\pi x}{10} \sin \frac{n\pi t}{10}.$$

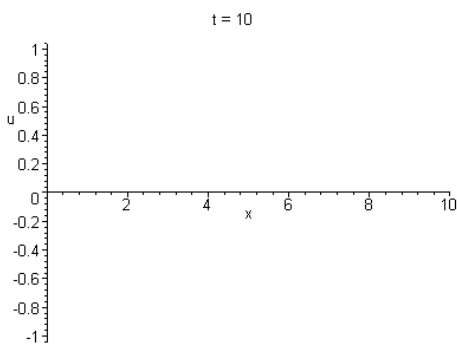
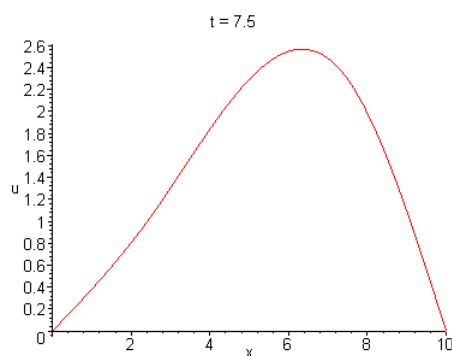
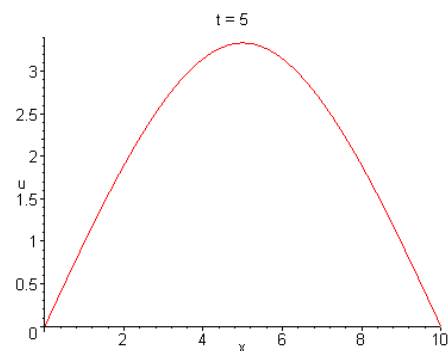
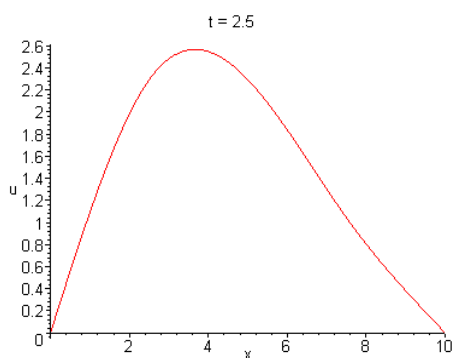

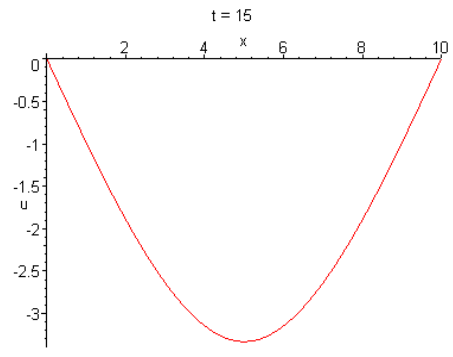
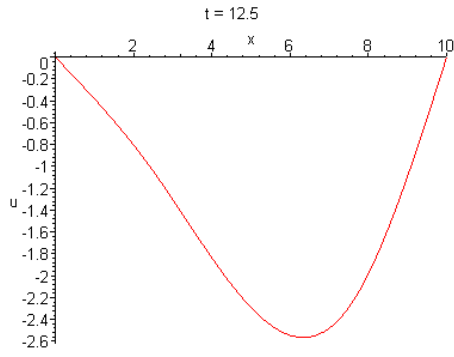

(c).

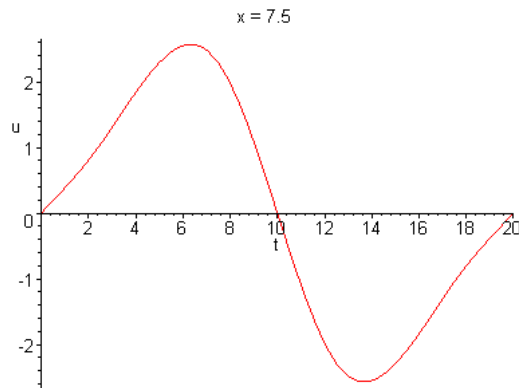
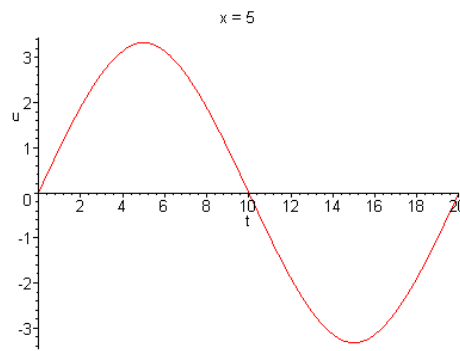
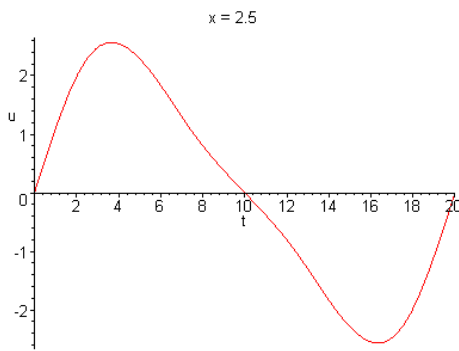

(d).

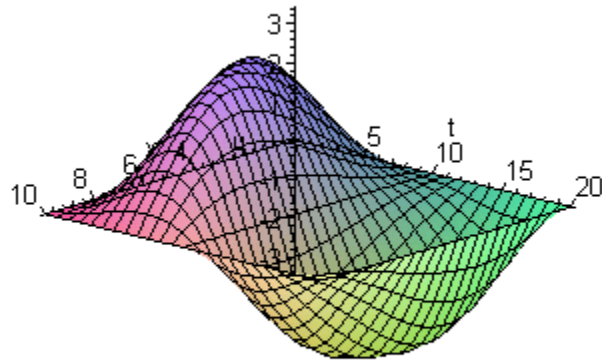
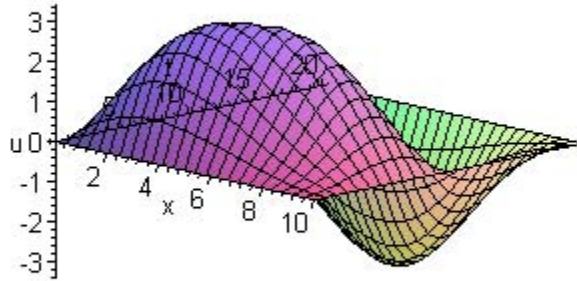

8(a). As given by Eq. (34), the solution is

$$u(x, t) = \sum_{n=1}^{\infty} k_n \sin \frac{n\pi x}{L} \sin \frac{n\pi a t}{L},$$

in which the coefficients are the Fourier *sine* coefficients of  $u_t(x, 0) = g(x)$ . It follows that



$$\begin{aligned}
 k_n &= \frac{2}{n\pi a} \int_0^L g(x) \sin \frac{n\pi x}{L} dx \\
 &= \frac{2}{n\pi a} \int_{L/2-1}^{L/2+1} \sin \frac{n\pi x}{L} dx \\
 &= 4L \frac{\sin \frac{n\pi}{2} \sin \frac{n\pi}{L}}{n^2 \pi^2 a}.
 \end{aligned}$$

Therefore the displacement of the string is given by

$$u(x, t) = \frac{4L}{a\pi^2} \sum_{n=1}^{\infty} \frac{1}{n^2} \left[ \sin \frac{n\pi}{2} \sin \frac{n\pi}{L} \right] \sin \frac{n\pi x}{L} \sin \frac{n\pi a t}{L}.$$

(b). With  $a = 1$  and  $L = 10$ ,

$$u(x, t) = \frac{40}{\pi^2} \sum_{n=1}^{\infty} \frac{1}{n^2} \left[ \sin \frac{n\pi}{2} \sin \frac{n\pi}{10} \right] \sin \frac{n\pi x}{10} \sin \frac{n\pi t}{10}.$$

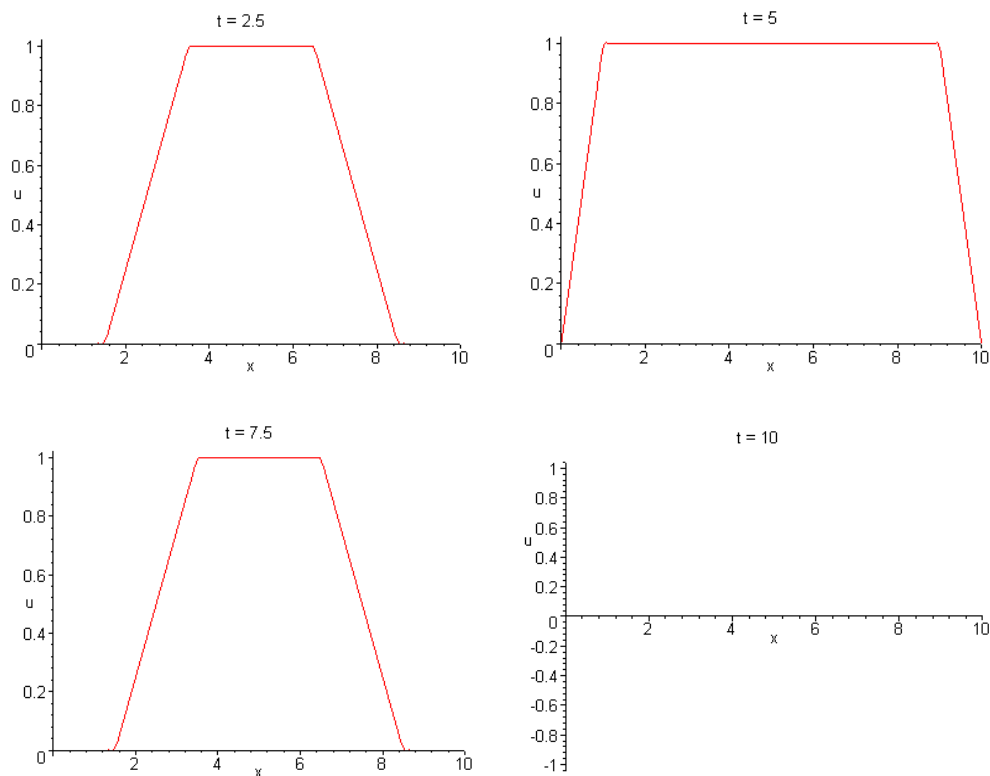

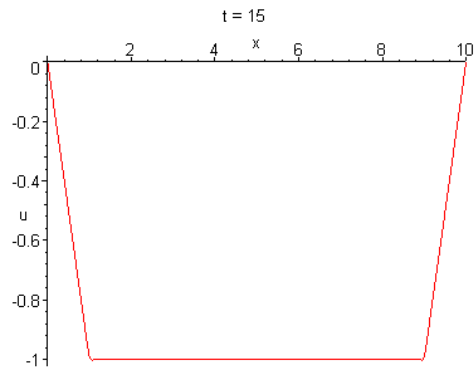
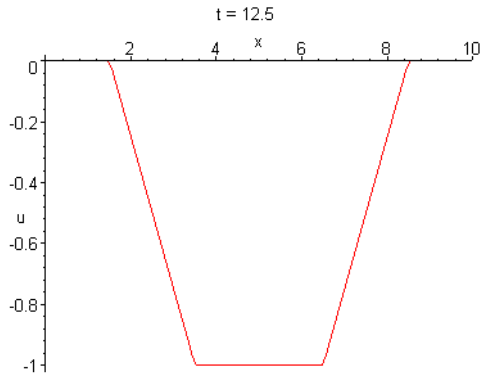

(c).

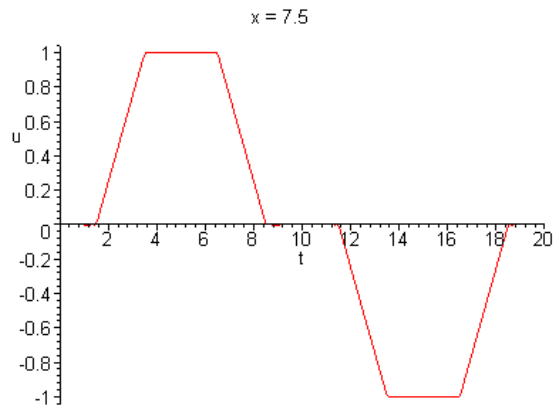
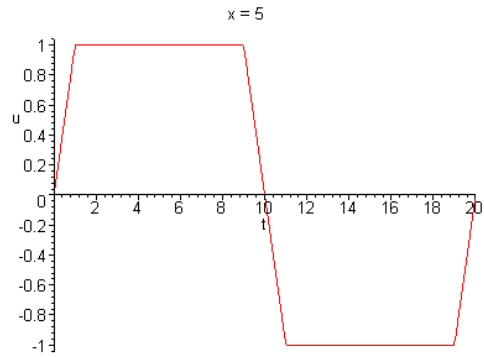
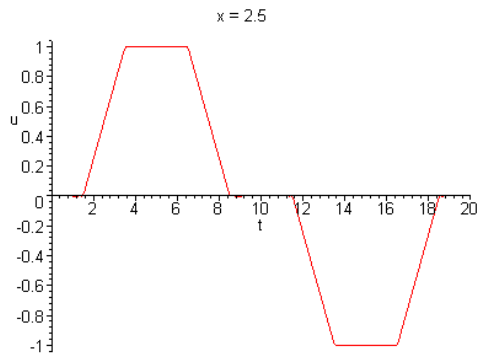

(d).

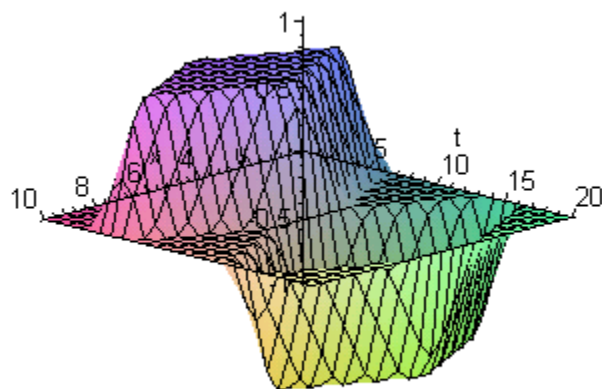
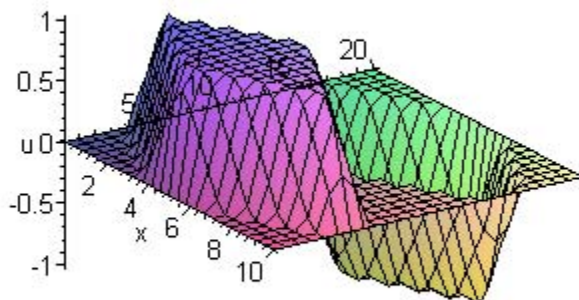

11(a). As shown in Prob. 9, the solution is

$$u(x, t) = \sum_{n=1}^{\infty} c_n \sin \frac{(2n-1)\pi x}{2L} \cos \frac{(2n-1)\pi a t}{2L},$$

in which the coefficients are the Fourier *sine* coefficients of  $f(x)$ . It follows that

$$\begin{aligned}
 c_n &= \frac{2}{L} \int_0^L f(x) \sin \frac{(2n-1)\pi x}{2L} dx \\
 &= \frac{2}{L} \int_0^L \frac{8x(L-x)^2}{L^3} \sin \frac{(2n-1)\pi x}{2L} dx \\
 &= 512 \frac{3\cos n\pi + (2n-1)\pi}{(2n-1)^4 \pi^4}.
 \end{aligned}$$

Therefore the displacement of the string is given by

$$u(x, t) = \frac{512}{\pi^4} \sum_{n=1}^{\infty} \frac{3\cos n\pi + (2n-1)\pi}{(2n-1)^4} \sin \frac{(2n-1)\pi x}{2L} \cos \frac{(2n-1)\pi a t}{2L}.$$

Note that the period is  $T = 4L/a$ .

(b). With  $a = 1$  and  $L = 10$ ,

$$u(x, t) = \frac{512}{\pi^4} \sum_{n=1}^{\infty} \frac{3\cos n\pi + (2n-1)\pi}{(2n-1)^4} \sin \frac{(2n-1)\pi x}{20} \cos \frac{(2n-1)\pi t}{20}.$$

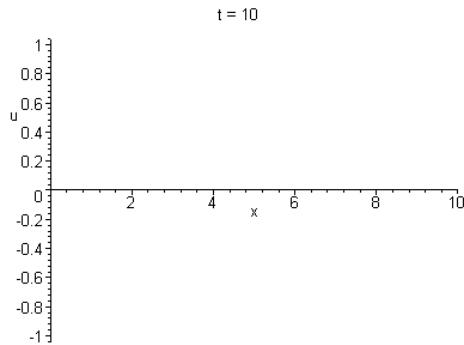
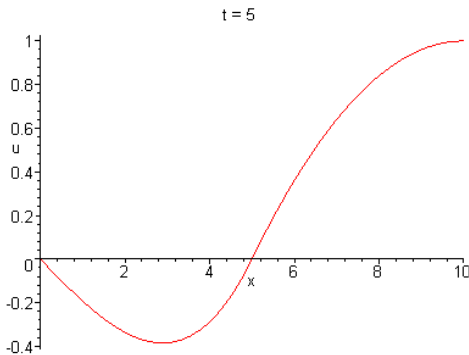
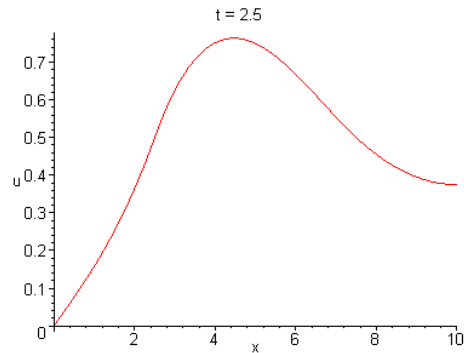
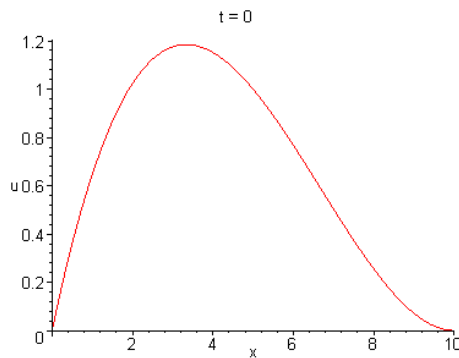

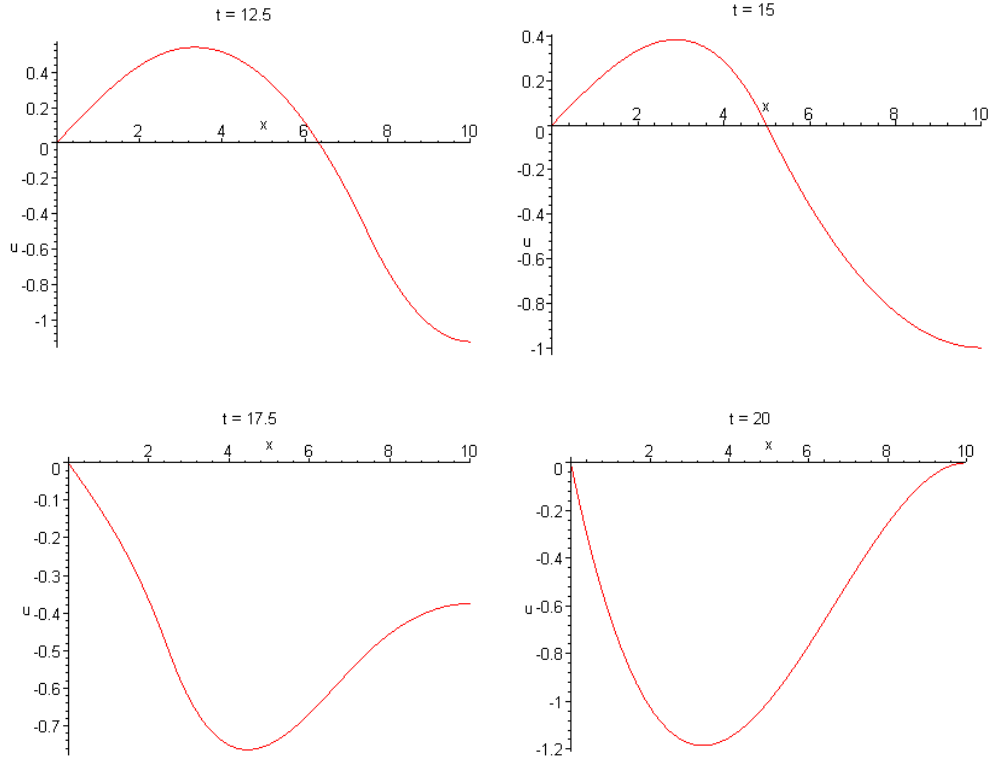

(c).

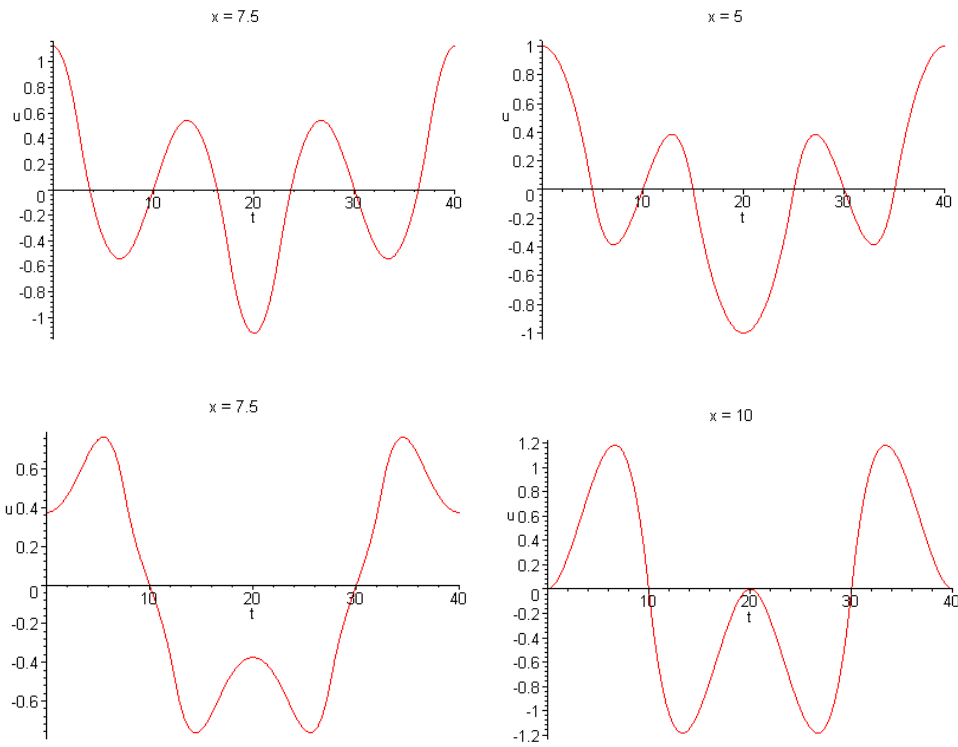

(d).

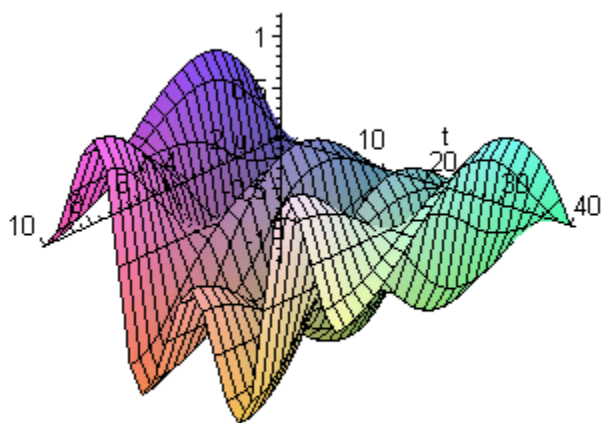
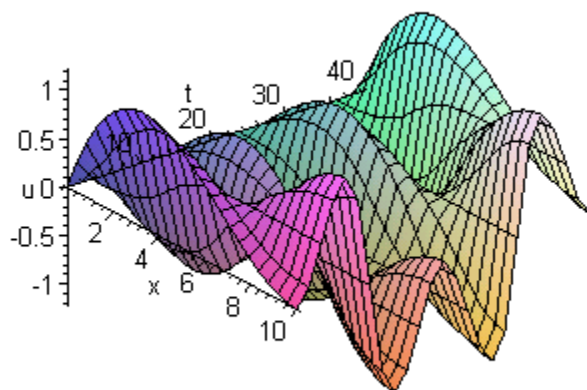

12. The *wave equation* is given by

$$a^2 \frac{\partial^2 u}{\partial x^2} = \frac{\partial^2 u}{\partial t^2}.$$

Setting  $s = x/L$ , we have

$$\frac{\partial u}{\partial x} = \frac{\partial u}{\partial s} \frac{ds}{dx} = \frac{1}{L} \frac{\partial u}{\partial s}.$$

It follows that

$$\frac{\partial^2 u}{\partial x^2} = \frac{1}{L^2} \frac{\partial^2 u}{\partial s^2}.$$

Likewise, with  $\tau = at/L$ ,

$$\frac{\partial u}{\partial t} = \frac{a}{L} \frac{\partial u}{\partial \tau} \quad \text{and} \quad \frac{\partial^2 u}{\partial t^2} = \frac{a^2}{L^2} \frac{\partial^2 u}{\partial \tau^2}.$$

Substitution into the original equation results in

$$\frac{\partial^2 u}{\partial s^2} = \frac{\partial^2 u}{\partial \tau^2}.$$

15. The given specifications are  $L = 5 \text{ ft}$ ,  $T = 50 \text{ lb}$ , and *weight* per unit length  $\gamma = 0.026 \text{ lb/ft}$ . It follows that  $\rho = \gamma/32.2 = 80.75 \times 10^{-5} \text{ slugs/ft}$ .

(a). The transverse waves propagate with a speed of  $a = \sqrt{T/\rho} = 248 \text{ ft/sec}$ .

(b). The *natural frequencies* are  $\omega_n = n\pi a/L = 49.8 \pi n \text{ rad/sec}$ .

(c). The new wave speed is  $a = \sqrt{(T + \Delta T)/\rho}$ . For a string with fixed ends, the natural modes are proportional to the functions

$$M_n(x) = \sin \frac{n\pi x}{L},$$

which are independent of  $a$ .

19. The solution of the wave equation

$$a^2 v_{xx} = v_{tt}$$

in an infinite one-dimensional medium subject to the initial conditions

$$v(x, 0) = f(x), \quad v_t(x, 0) = 0, \quad -\infty < x < \infty$$

is given by

$$v(x, t) = \frac{1}{2} [f(x - at) + f(x + at)].$$

The solution of the wave equation

$$a^2 w_{xx} = w_{tt},$$

on the same domain, subject to the initial conditions

$$w(x, 0) = 0, \quad w_t(x, 0) = g(x), \quad -\infty < x < \infty$$

is given by

$$w(x, t) = \frac{1}{2a} \int_{x-at}^{x+at} g(\xi) d\xi.$$

Let  $u(x, t) = v(x, t) + w(x, t)$ . Since the PDE is *linear*, it is easy to see that  $u(x, t)$  is a solution of the wave equation  $a^2 u_{xx} = u_{tt}$ . Furthermore, we have

$$u(x, 0) = v(x, 0) + w(x, 0) = f(x)$$

and

$$u_t(x, 0) = v_t(x, 0) + w_t(x, 0) = g(x).$$

Hence  $u(x, t)$  is a solution of the general wave propagation problem.

20. The solution of the specified wave propagation problem is

$$u(x, t) = \sum_{n=1}^{\infty} c_n \sin \frac{n\pi x}{L} \cos \frac{n\pi a t}{L}.$$

Using a standard trigonometric identity,

$$\begin{aligned} \sin \frac{n\pi x}{L} \cos \frac{n\pi a t}{L} &= \frac{1}{2} \left[ \sin \left( \frac{n\pi x}{L} + \frac{n\pi a t}{L} \right) + \sin \left( \frac{n\pi x}{L} - \frac{n\pi a t}{L} \right) \right] \\ &= \frac{1}{2} \left[ \sin \frac{n\pi}{L} (x + at) + \sin \frac{n\pi}{L} (x - at) \right]. \end{aligned}$$

We can therefore also write the solution as

$$u(x, t) = \frac{1}{2} \sum_{n=1}^{\infty} c_n \left[ \sin \frac{n\pi}{L} (x + at) + \sin \frac{n\pi}{L} (x - at) \right].$$

Assuming that the series can be split up,

$$u(x, t) = \frac{1}{2} \left[ \sum_{n=1}^{\infty} c_n \sin \frac{n\pi}{L} (x - at) + \sum_{n=1}^{\infty} c_n \sin \frac{n\pi}{L} (x + at) \right].$$

Comparing the solution to the one given by Eq. (28), we can infer that

$$h(x) = \sum_{n=1}^{\infty} c_n \sin \frac{n\pi x}{L}.$$

21. Let  $h(\xi)$  be a  $2L$ -periodic function defined by

$$h(\xi) = \begin{cases} f(\xi), & 0 \leq \xi \leq L; \\ -f(-\xi), & -L \leq \xi \leq 0. \end{cases}$$

Set  $u(x, t) = \frac{1}{2}[h(x - at) + h(x + at)]$ . Assuming the appropriate differentiability



conditions on  $h$ ,

$$\frac{\partial u}{\partial x} = \frac{1}{2}[h'(x - at) + h'(x + at)]$$

and

$$\frac{\partial^2 u}{\partial x^2} = \frac{1}{2}[h''(x - at) + h''(x + at)].$$

Likewise,

$$\frac{\partial^2 u}{\partial t^2} = \frac{a^2}{2}[h''(x - at) + h''(x + at)].$$

It follows immediately that

$$a^2 \frac{\partial^2 u}{\partial x^2} = \frac{\partial^2 u}{\partial t^2}.$$

Let  $t \geq 0$ . Checking the first boundary condition,

$$u(0, t) = \frac{1}{2}[h(-at) + h(at)] = \frac{1}{2}[-h(at) + h(at)] = 0.$$

Checking the other boundary condition,

$$\begin{aligned} u(L, t) &= \frac{1}{2}[h(L - at) + h(L + at)] \\ &= \frac{1}{2}[-h(at - L) + h(at + L)]. \end{aligned}$$

Since  $h$  is  $2L$ -periodic,  $h(at - L) = h(at - L + 2L)$ . Therefore  $u(L, t) = 0$ . Furthermore, for  $0 \leq x \leq L$ ,

$$u(x, 0) = \frac{1}{2}[h(x) + h(x)] = h(x) = f(x).$$

Hence  $u(x, t)$  is a solution of the problem.

23. Assuming that we can differentiate term-by-term,

$$\frac{\partial u}{\partial t} = -\pi a \sum_{n=1}^{\infty} \frac{c_n n}{L} \sin \frac{n\pi x}{L} \sin \frac{n\pi a t}{L}$$

and

$$\frac{\partial u}{\partial x} = \pi \sum_{n=1}^{\infty} \frac{c_n n}{L} \cos \frac{n\pi x}{L} \cos \frac{n\pi a t}{L}.$$

Formally,

$$\begin{aligned} \left(\frac{\partial u}{\partial t}\right)^2 &= \pi^2 a^2 \sum_{n=1}^{\infty} \left(\frac{c_n n}{L}\right)^2 \sin^2 \frac{n\pi x}{L} \sin^2 \frac{n\pi a t}{L} + \\ &\quad + \pi^2 a^2 \sum_{n \neq m}^{\infty} F_{nm}(x, t) \end{aligned}$$

and

$$\begin{aligned} \left(\frac{\partial u}{\partial x}\right)^2 &= \pi^2 \sum_{n=1}^{\infty} \left(\frac{c_n n}{L}\right)^2 \cos^2 \frac{n\pi x}{L} \cos^2 \frac{n\pi a t}{L} + \\ &\quad + \pi^2 \sum_{n \neq m}^{\infty} G_{nm}(x, t), \end{aligned}$$

in which  $F_{nm}(x, t)$  and  $G_{nm}(x, t)$  contain *products* of the natural modes and their derivatives. Based on the *orthogonality* of the natural modes,

$$\int_0^L \left(\frac{\partial u}{\partial t}\right)^2 dx = \pi^2 a^2 \frac{L}{2} \sum_{n=1}^{\infty} \left(\frac{c_n n}{L}\right)^2 \sin^2 \frac{n\pi a t}{L}$$

and

$$\int_0^L \left(\frac{\partial u}{\partial x}\right)^2 dx = \pi^2 \frac{L}{2} \sum_{n=1}^{\infty} \left(\frac{c_n n}{L}\right)^2 \cos^2 \frac{n\pi a t}{L}.$$

Recall that  $a^2 = T/\rho$ . It follows that

$$\begin{aligned} \int_0^L \left[ \rho \left(\frac{\partial u}{\partial t}\right)^2 + T \left(\frac{\partial u}{\partial x}\right)^2 \right] dx &= \pi^2 \frac{TL}{2} \sum_{n=1}^{\infty} \left(\frac{c_n n}{L}\right)^2 \sin^2 \frac{n\pi a t}{L} + \\ &\quad + \pi^2 \frac{TL}{2} \sum_{n=1}^{\infty} \left(\frac{c_n n}{L}\right)^2 \cos^2 \frac{n\pi a t}{L}. \end{aligned}$$

Therefore,

$$\int_0^L \left[ \frac{1}{2} \rho \left(\frac{\partial u}{\partial t}\right)^2 + \frac{1}{2} T \left(\frac{\partial u}{\partial x}\right)^2 \right] dx = \pi^2 \frac{T}{4L} \sum_{n=1}^{\infty} n^2 c_n^2.$$

## Chapter Eleven

### Section 11.1

1. Since the right hand sides of the ODE and the boundary conditions are all *zero*, the boundary value problem is *homogeneous*.
3. The right hand side of the ODE is *nonzero*. Therefore the boundary value problem is *nonhomogeneous*.
6. The ODE can also be written as

$$y'' + \lambda(1 + x^2)y = 0.$$

Although the second boundary condition has a more general form, the boundary value problem is *homogeneous*.

7. First assume that  $\lambda = 0$ . The general solution of the ODE is  $y(x) = c_1x + c_2$ . The boundary condition at  $x = 0$  requires that  $c_2 = 0$ . Imposing the second condition,

$$c_1(\pi + 1) + c_2 = 0.$$

It follows that  $c_1 = c_2 = 0$ . Hence there are no nontrivial solutions.

Suppose that  $\lambda = -\mu^2$ . In this case, the general solution of the ODE is

$$y(x) = c_1 \cosh \mu x + c_2 \sinh \mu x.$$

The first boundary condition requires that  $c_1 = 0$ . Imposing the second condition,

$$c_1(\cosh \mu\pi + \mu \sinh \mu\pi) + c_2(\sinh \mu\pi + \mu \cosh \mu\pi) = 0.$$

The two boundary conditions result in

$$c_2(\tanh \mu\pi + \mu) = 0.$$

Since the *only* solution of the equation  $\tanh \mu\pi + \mu = 0$  is  $\mu = 0$ , we have  $c_2 = 0$ . Hence there are no nontrivial solutions.

Let  $\lambda = \mu^2$ , with  $\mu > 0$ . Then the general solution of the ODE is

$$y(x) = c_1 \cos \mu x + c_2 \sin \mu x.$$

Imposing the boundary conditions, we obtain  $c_1 = 0$  and

$$c_1(\cos \mu\pi - \mu \sin \mu\pi) + c_2(\sin \mu\pi + \mu \cos \mu\pi) = 0.$$

For a *nontrivial* solution of the ODE, we require that  $\sin \mu\pi + \mu \cos \mu\pi = 0$ . Note that

$$\cos \mu\pi = 0 \Rightarrow \sin \mu\pi = 0,$$

which is false. It follows that  $\tan \mu\pi = -\mu$ . From a plot of  $\pi \tan \pi\mu$  and  $-\pi\mu$ ,

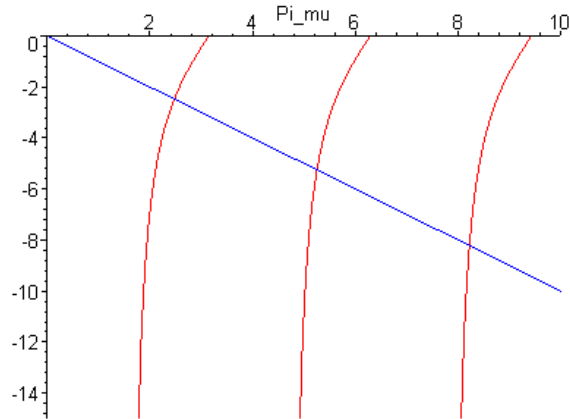

we find that there is a sequence of solutions,  $\mu_1 \approx 0.7876$ ,  $\mu_2 \approx 1.6716$ ,  $\dots$ ; For large values of  $n$ ,

$$\pi \mu_n \approx (2n - 1) \frac{\pi}{2}.$$

Therefore the eigenfunctions are  $\phi_n(x) = \sin \mu_n x$ , with corresponding eigenvalues

$$\lambda_1 \approx 0.6204, \lambda_2 \approx 2.7943, \dots.$$

Asymptotically,

$$\lambda_n \approx \frac{(2n - 1)^2}{4}.$$

8. With  $\lambda = 0$ , the general solution of the ODE is  $y(x) = c_1 x + c_2$ . Imposing the two boundary conditions,  $c_1 = 0$  and  $2c_1 + c_2 = 0$ . It follows that  $c_1 = c_2 = 0$ . Hence there are no nontrivial solutions.

Setting  $\lambda = -\mu^2$ , the general solution of the ODE is

$$y(x) = c_1 \cosh \mu x + c_2 \sinh \mu x.$$

The first boundary condition requires that  $c_2 = 0$ . Imposing the second condition,

$$c_1 (\cosh \mu + \mu \sinh \mu) + c_2 (\sinh \mu + \mu \cosh \mu) = 0.$$

The two boundary conditions result in

$$c_1 (1 + \mu \tanh \mu) = 0.$$

Since  $\mu \tanh \mu \geq 0$ , it follows that  $c_1 = 0$ , and there are no nontrivial solutions.

Let  $\lambda = \mu^2$ , with  $\mu > 0$ . Then the general solution of the ODE is

$$y(x) = c_1 \cos \mu x + c_2 \sin \mu x.$$

Imposing the boundary conditions, we obtain  $c_2 = 0$  and

$$c_1(\cos \mu - \mu \sin \mu) + c_2(\sin \mu + \mu \cos \mu) = 0.$$

For a *nontrivial* solution of the ODE, we require that  $\cos \mu - \mu \sin \mu = 0$ . First note that

$$\cos \mu = 0 \Rightarrow \mu = 0 \text{ or } \sin \mu = 0.$$

Therefore we find that  $1 - \mu \tan \mu = 0$ . From a plot of  $\mu \tan \mu$ , there is a sequence of

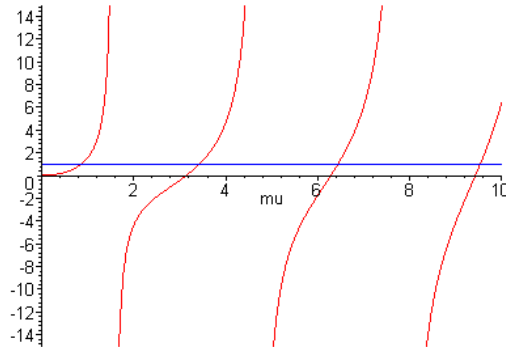

solutions,  $\mu_1 \approx 0.8603$ ,  $\mu_2 \approx 3.4256$ ,  $\dots$ ; For large  $n$ ,

$$\mu_n \approx (n - 1)\pi.$$

Therefore the eigenfunctions are  $\phi_n(x) = \cos \mu_n x$ , with corresponding eigenvalues

$$\lambda_1 \approx 0.7402, \lambda_2 \approx 11.7349, \dots.$$

Asymptotically,

$$\lambda_n \approx (n - 1)^2 \pi^2.$$

12. First note that  $P(x) = 1$ ,  $Q(x) = -2x$  and  $R(x) = \lambda$ . Based on Prob. 11, the integrating factor is a solution of the ODE

$$\mu'(x) = -2x \mu(x).$$

The differential equation is first order linear, with solution  $\mu(x) = c \exp(-x^2)$ . It then follows that the *Hermite equation* can be written as

$$\left[ e^{-x^2} y' \right]' + \lambda e^{-x^2} y = 0.$$

14. For the *Laguerre equation*,  $P(x) = x$ ,  $Q(x) = 1 - x$  and  $R(x) = \lambda$ . Using the result of Prob. 11, the integrating factor is a solution of the ODE

$$x \mu'(x) = -x \mu(x).$$

The general solution of  $\mu'(x) = -\mu(x)$  is  $\mu(x) = c e^{-x}$ . Therefore the *Laguerre equation* can be written as

$$[x e^{-x} y']' + \lambda e^{-x} y = 0.$$

15. For the *Chebyshev equation*,  $P(x) = 1 - x^2$ ,  $Q(x) = -x$  and  $R(x) = \alpha^2$ . The integrating factor is a solution of the ODE

$$(1 - x^2)\mu'(x) = x \mu(x).$$

The differential equation is separable, with

$$\frac{d\mu}{\mu} = \frac{x}{1 - x^2}.$$

The general solution of the resulting ODE is

$$\mu(x) = \frac{c}{\sqrt{|1 - x^2|}}.$$

Recall that the *Chebyshev equation* is typically defined for  $|x| \leq 1$ . Therefore it can also be written as

$$\left[\sqrt{1 - x^2} y'\right]' + \frac{\alpha^2}{\sqrt{1 - x^2}} y = 0.$$

16. We consider solutions of the form  $u(x, t) = X(x)T(t)$ . Substitution into the PDE results in

$$XT'' + cXT' + kXT = \alpha^2 X''T.$$

Dividing both sides of the equation by  $XT$ , we obtain

$$\frac{XT''}{XT} + c \frac{XT'}{XT} + k = \alpha^2 \frac{X''T}{XT},$$

that is,

$$\frac{T''}{T} + c \frac{T'}{T} = \alpha^2 \frac{X''}{X} - k.$$

Since both sides of the resulting equation are functions of different variables, each must be

equal to a constant, say  $-\lambda$ . Therefore we obtain two ordinary differential equations

$$\alpha^2 X'' + (\lambda - k)X = 0 \quad \text{and} \quad T'' + cT' + \lambda T = 0.$$

17(a). Setting  $y = s(x)u$ , we have  $y' = s'u + s u'$  and  $y'' = s''u + 2s'u' + s u''$ . Substitution into the given ODE results in

$$s''u + 2s'u' + s u'' - 2(s'u + s u') + (1 + \lambda)su = 0.$$

Collecting the various terms,

$$s u'' + (2s' - 2s)u' + [s'' - 2s' + (1 + \lambda)s]u = 0.$$

The second term on the left vanishes as long as  $s' = s$ .

(b). With  $s(x) = e^x$ , the transformed differential equation can be written as

$$u'' + \lambda u = 0.$$

Since the boundary conditions are *homogeneous*, we also have  $u(0) = u(1) = 0$ . It now follows that the eigenfunctions are  $u_n = \sin \sqrt{\lambda_n} x$ , with corresponding eigenvalues

$$\lambda_n = n^2 \pi^2.$$

Therefore the eigenfunctions for the original problem are  $\phi_n(x) = e^x \sin n\pi x$ , with corresponding eigenvalues

$$1 + \lambda_n = 1 + n^2 \pi^2.$$

(c). The given equation is a second order *constant coefficient* differential equation. The characteristic equation is

$$r^2 - 2r + (1 + \lambda) = 0,$$

with roots  $r_{1,2} = 1 \pm \sqrt{-\lambda}$ .

If  $\lambda = 0$ , then the general solution is  $y = c_1 e^x + c_2 x e^x$ . Imposing the two boundary conditions, we find that  $c_1 = c_2 = 0$ , and hence there are no nontrivial solutions. If  $\lambda < 0$ , then the general solution is

$$y = c_1 \exp(1 + \sqrt{-\lambda})x + c_2 \exp(1 - \sqrt{-\lambda})x.$$

It again follows that  $c_1 = c_2 = 0$ , and hence there are no nontrivial solutions.

Therefore  $\lambda > 0$ , and the general solution is

$$y = c_1 e^x \cos \sqrt{\lambda} x + c_2 e^x \sin \sqrt{\lambda} x.$$

Invoking the boundary conditions, we have  $c_1 = 0$  and  $c_2 e \sin \sqrt{\lambda} = 0$ . For a nontrivial solution,  $\sqrt{\lambda} = n\pi$ .

19. First write the differential equation as

$$y'' + (1 + \lambda)y' + \lambda y = 0,$$

which is a second order *constant coefficient* differential equation. The characteristic equation is

$$r^2 + (1 + \lambda)r + \lambda = 0,$$

with roots  $r_1 = -1$  and  $r_2 = -\lambda$ . For  $\lambda \neq 1$ , the general solution is

$$y = c_1 e^{-x} + c_2 e^{-\lambda x}.$$

Imposing the boundary conditions, we require that  $c_1 + c_2 = 0$  and  $c_1 e^{-1} + c_2 e^{-\lambda} = 0$ . For a nontrivial solution, it follows that  $e^{-1} = e^{-\lambda}$ , and hence  $\lambda = 1$ , which is contrary to the assumption.

If  $\lambda = 1$ , then the general solution is

$$y = c_1 e^{-x} + c_2 x e^{-x}.$$

The boundary conditions require that  $c_1 = 0$  and  $c_1 e^{-1} + c_2 e^{-1} = 0$ . Hence there are no nontrivial solutions.

21. Suppose that  $\lambda = 0$ . In that case the general solution is  $y = c_1 x + c_2$ . The boundary conditions require that  $c_1 + 2c_2 = 0$  and  $c_1 + c_2 = 0$ . We find that  $c_1 = c_2 = 0$ , and hence there are no nontrivial solutions.

(a). Let  $\lambda = \mu^2$ , with  $\mu > 0$ . Then the general solution of the ODE is

$$y(x) = c_1 \cos \mu x + c_2 \sin \mu x.$$

The boundary conditions require that

$$2c_1 + \mu c_2 = 0 \text{ and } c_1 \cos \mu + c_2 \sin \mu = 0.$$

These equations have a nonzero solution only if

$$2 \sin \mu - \mu \cos \mu = 0,$$

which can also be written as

$$2 \tan \mu - \mu = 0.$$

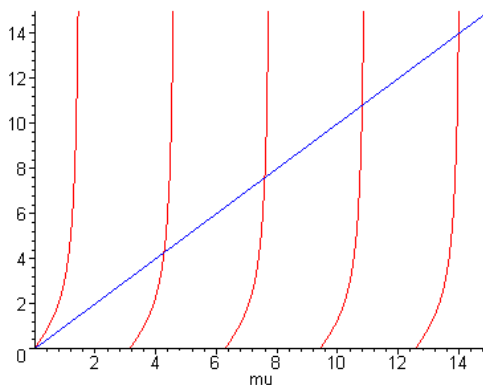

Based on the graph, the positive roots of the determinantal equation are



$$\mu_1 \approx 4.2748, \mu_2 \approx 7.5965, \dots; \text{ for large } n, \mu_n \approx (2n + 1)\frac{\pi}{2}.$$

Therefore the eigenvalues are

$$\lambda_1 \approx 18.2738, \lambda_2 \approx 57.7075, \dots; \text{ for large } n, \lambda_n \approx (2n + 1)^2 \frac{\pi^2}{4}.$$

(b). Setting  $\lambda = -\mu^2 < 0$ , the general solution of the ODE is

$$y(x) = c_1 \cosh \mu x + c_2 \sinh \mu x.$$

Imposing the boundary conditions, we obtain the equations

$$2c_1 + \mu c_2 = 0 \text{ and } c_1 \cosh \mu + c_2 \sinh \mu = 0.$$

These equations have a nonzero solution only if

$$2\sinh \mu - \mu \cosh \mu = 0.$$

The latter equation is satisfied only for  $\mu = 0$  and  $\mu = \pm 1.9150$ . Hence the only *negative* eigenvalue is  $\lambda_{-1} = 3.6673$ .

24. Based on the physical problem,  $\lambda = m\omega^2/EI > 0$ . Let  $\lambda = \mu^4$ . The characteristic equation is  $r^4 - \mu^4 = 0$ , with roots  $r_{1,2} = \pm \mu i$ ,  $r_3 = -\mu$  and  $r_4 = \mu$ . Hence the general solution is

$$y(x) = c_1 \cosh \mu x + c_2 \sinh \mu x + c_3 \cos \mu x + c_4 \sin \mu x.$$

(a). Simply supported on both ends :  $y(0) = y''(0) = 0$ ;  $y(L) = y''(L) = 0$ .

Invoking the boundary conditions, we obtain the system of equations

$$\begin{aligned} c_1 + c_3 &= 0 \\ c_1 - c_3 &= 0 \\ c_1 \cosh \mu L + c_2 \sinh \mu L + c_3 \cos \mu L + c_4 \sin \mu L &= 0 \\ c_1 \mu^2 \cosh \mu L + c_2 \mu^2 \sinh \mu L - c_3 \mu^2 \cos \mu L - c_4 \mu^2 \sin \mu L &= 0. \end{aligned}$$

The determinantal equation is

$$\mu^4 \sinh \mu L \sin \mu L = 0.$$

The nonzero roots are  $\mu_n = n\pi/L$ ,  $n = 1, 2, \dots$ . The first two equations result in  $c_1 = c_3 = 0$ . The last two equations,

$$\begin{aligned} c_2 \sinh n\pi + c_4 \sin n\pi &= 0 \\ c_2 \sinh n\pi - c_4 \sin n\pi &= 0, \end{aligned}$$

imply that  $c_2 = 0$ . Therefore the eigenfunctions are  $\phi_n = \sin \mu_n x$ , with corresponding eigenvalues  $\lambda_n = n^4 \pi^4 / L^4$ .

(b). Simply supported :  $y(0) = y''(0) = 0$ ; clamped :  $y(L) = y'(L) = 0$ .  
 Invoking the boundary conditions, we obtain the system of equations

$$\begin{aligned} c_1 + c_3 &= 0 \\ c_1 - c_3 &= 0 \\ c_1 \cosh \mu L + c_2 \sinh \mu L + c_3 \cos \mu L + c_4 \sin \mu L &= 0 \\ c_1 \mu \sinh \mu L + c_2 \mu \cosh \mu L - c_3 \mu \sin \mu L + c_4 \mu \cos \mu L &= 0. \end{aligned}$$

The determinantal equation is

$$2\mu^3 \sinh \mu L \cos \mu L - 2\mu^3 \cosh \mu L \sin \mu L = 0.$$

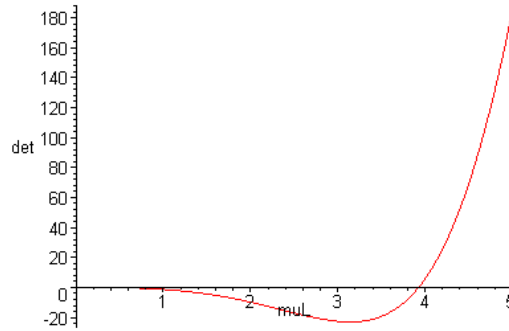

Based on numerical analysis,  $\mu_1 \approx 3.9266/L$  and  $\mu_2 \approx 7.0686/L$ .

The first two equations result in  $c_1 = c_3 = 0$ . The last two equations,

$$\begin{aligned} c_2 \sinh \mu_n L + c_4 \sin \mu_n L &= 0 \\ c_2 \cosh \mu_n L + c_4 \cos \mu_n L &= 0, \end{aligned}$$

imply that

$$c_2 = - \frac{\sin \mu_n L}{\sinh \mu_n L} c_4.$$

Therefore the eigenfunctions are

$$\phi_n = - \frac{\sin \mu_n L}{\sinh \mu_n L} \sinh \mu_n x + \sin \mu_n x,$$

with corresponding eigenvalues  $\lambda_n = \mu_n^4$ .

(c). Clamped :  $y(0) = y'(0) = 0$ ; free :  $y''(L) = y'''(L) = 0$ .  
 Invoking the boundary conditions, we obtain the system of equations

$$\begin{aligned}
 c_1 + c_3 &= 0 \\
 \mu c_2 + \mu c_4 &= 0 \\
 c_1 \mu^2 \cosh \mu L + c_2 \mu^2 \sinh \mu L - c_3 \mu^2 \cos \mu L - c_4 \mu^2 \sin \mu L &= 0 \\
 c_1 \mu^3 \sinh \mu L + c_2 \mu^3 \cosh \mu L + c_3 \mu^3 \sin \mu L - c_4 \mu^3 \cos \mu L &= 0.
 \end{aligned}$$

The determinantal equation is

$$1 + \cosh \mu L \cos \mu L = 0.$$

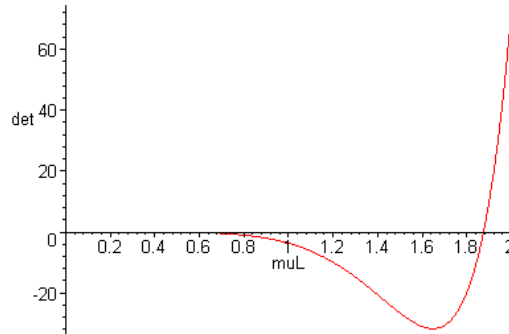

The first two *nonzero* roots are  $\mu_1 \approx 1.8751/L$  and  $\mu_2 \approx 4.6941/L$ . With  $c_3 = -c_1$  and  $c_4 = -c_2$ , the system of equations reduce to

$$\begin{aligned}
 c_1(\cosh \mu_n L + \cos \mu_n L) + c_2(\sinh \mu_n L + \sin \mu_n L) &= 0 \\
 c_1(\sinh \mu_n L - \sin \mu_n L) + c_2(\cosh \mu_n L + \cos \mu_n L) &= 0.
 \end{aligned}$$

Let  $A_n = (\cosh \mu_n L + \cos \mu_n L) / (\sinh \mu_n L + \sin \mu_n L)$ . The eigenfunctions are given by

$$\phi_n(x) = \cosh \mu_n x - \cos \mu_n x + A_n(\sin \mu_n x - \sinh \mu_n x),$$

with corresponding eigenvalues  $\lambda_n = \mu_n^4$ .

25(a). Assume that the solution has the form  $u(x, t) = X(x)T(t)$ . Substitution into the PDE results in

$$\frac{E}{\rho} X''T = XT''.$$

Dividing both sides of the equation by  $XT$ , we obtain

$$\frac{E}{\rho} \frac{X''T}{XT} = \frac{XT''}{XT},$$

that is,

$$\frac{X''}{X} = \frac{\rho}{E} \frac{T''}{T}.$$

Since both sides of the resulting equation are functions of different variables, each must be

equal to a constant, say  $-\lambda$ . Therefore we obtain two ordinary differential equations

$$X'' + \lambda X = 0 \quad \text{and} \quad T'' + \lambda \frac{E}{\rho} T = 0.$$

(b). Given that  $u(0, t) = X(0)T(t)$  for  $t > 0$ , it follows that  $X(0) = 0$ . The second boundary condition can be expressed as

$$EAX'(L)T(t) + mX(L)T''(t) = 0, \quad t > 0.$$

From the result in Part (a),

$$EAX'(L)T(t) - \lambda m \frac{E}{\rho} X(L)T(t) = 0, \quad t > 0.$$

Since the condition is to be satisfied for all  $t > 0$ , we arrive at the boundary condition

$$X'(L) - \lambda \frac{m}{\rho A} X(L) = 0.$$

(c). If  $\lambda = 0$ , the general solution of the spatial equation is

$$X(x) = c_1 x + c_2.$$

The boundary condition require that  $c_1 = c_2 = 0$ . Hence there are no nontrivial solutions.

If  $\lambda = -\mu^2 < 0$ , then the general solution is

$$X(x) = c_1 \cosh \mu x + c_2 \sinh \mu x.$$

The first boundary condition implies that  $c_1 = 0$ . The second boundary condition requires that

$$c_2 \cosh \mu L + c_2 \mu \frac{m}{\rho A} \sinh \mu L = 0.$$

The solution is nontrivial only if

$$\mu \tanh \mu L = -\frac{\rho A}{m}.$$

Since  $\mu \tanh \mu L \geq 0$ , there are no nontrivial solutions.

Let  $\lambda = \mu^2 > 0$ . The general solution of the spatial equation is

$$X(x) = c_1 \cos \mu x + c_2 \sin \mu x.$$

The first boundary condition implies that  $c_1 = 0$ . The second boundary condition requires that

$$c_2 \cos \mu L - c_2 \mu \frac{m}{\rho A} \sin \mu L = 0.$$

For a nontrivial solution, it is necessary that

$$\cos \mu L - \mu \frac{m}{\rho A} \sin \mu L = 0,$$

or

$$\tan \mu L = \frac{\rho A}{m\mu}.$$

For the case  $(m/\rho AL) = 0.5$ ,

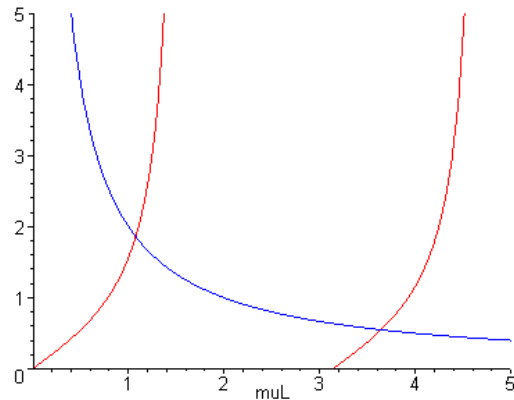

we find that  $\mu_1 L \approx 1.0769$  and  $\mu_2 L \approx 3.6436$ . Therefore the eigenfunctions are given by  $\phi_n(x) = \sin \mu_n x$ . The corresponding eigenvalues are solutions of

$$\cos \sqrt{\lambda_n} L - \frac{L}{2} \sqrt{\lambda_n} \sin \sqrt{\lambda_n} L = 0.$$

The first two eigenvalues are approximated as  $\lambda_1 \approx 1.1597/L^2$  and  $\lambda_2 \approx 13.276/L^2$ .

## Section 11.2

2. Based on the boundary conditions,  $\lambda > 0$ . The general solution of the ODE is

$$y(x) = c_1 \cos \sqrt{\lambda}x + c_2 \sin \sqrt{\lambda}x.$$

The boundary condition  $y'(0) = 0$  requires that  $c_2 = 0$ . Imposing the second boundary condition, we find that  $c_1 \cos \sqrt{\lambda} = 0$ . So for a nontrivial solution,  $\sqrt{\lambda} = (2n - 1)\pi/2$ ,  $n = 1, 2, \dots$ . Therefore the eigenfunctions are given by

$$\phi_n(x) = k_n \cos \frac{(2n - 1)\pi x}{2}.$$

In this problem,  $r(x) = 1$ , and the normalization condition is

$$k_n^2 \int_0^1 \left[ \cos \frac{(2n - 1)\pi x}{2} \right]^2 dx = 1.$$

It follows that  $k_n^2 = 2$ . Therefore the normalized eigenfunctions are

$$\phi_n(x) = \sqrt{2} \cos \frac{(2n - 1)\pi x}{2}, \quad n = 1, 2, \dots.$$

3. Based on the boundary conditions,  $\lambda \geq 0$ . For  $\lambda = 0$ , the eigenfunction is

$$\phi_0(x) = k_0.$$

Set  $k_0 = 1$ . With  $\lambda > 0$ , the general solution of the ODE is

$$y(x) = c_1 \cos \sqrt{\lambda}x + c_2 \sin \sqrt{\lambda}x.$$

Invoking the boundary conditions, we require that  $c_2 = 0$  and  $c_1 \sqrt{\lambda} \sin \sqrt{\lambda} = 0$ .

Since

$\lambda > 0$ , the eigenvalues are  $\lambda_n = n^2\pi^2$ ,  $n = 1, 2, \dots$ , with corresponding eigenfunctions

$$\phi_n(x) = k_n \cos n\pi x.$$

The normalization condition is

$$k_n^2 \int_0^1 \cos^2 n\pi x dx = 1.$$

It follows that  $k_n^2 = 2$ . Therefore the normalized eigenfunctions are

$$\phi_0(x) = 1, \text{ and } \phi_n(x) = \sqrt{2} \cos n\pi x, \quad n = 1, 2, \dots.$$

4. From Prob. 8 in Section 11.1, the eigenfunctions are  $\phi_n(x) = k_n \cos \sqrt{\lambda_n}x$ , in which

$\cos \sqrt{\lambda_n} - \sqrt{\lambda_n} \sin \sqrt{\lambda_n} = 0$ . The normalization condition is

$$k_n^2 \int_0^1 \cos^2 \sqrt{\lambda_n} x \, dx = 1.$$

First note that

$$\int_0^1 \cos^2 \sqrt{\lambda_n} x \, dx = \frac{\cos \sqrt{\lambda_n} \sin \sqrt{\lambda_n} + \sqrt{\lambda_n}}{2\sqrt{\lambda_n}}.$$

Based on the determinantal equation,

$$\begin{aligned} \frac{\cos \sqrt{\lambda_n} \sin \sqrt{\lambda_n} + \sqrt{\lambda_n}}{2\sqrt{\lambda_n}} &= \frac{1 + \sin^2 \sqrt{\lambda_n}}{2} \\ &= \frac{3 - \cos 2\sqrt{\lambda_n}}{4}. \end{aligned}$$

Therefore

$$k_n^2 = \frac{4}{3 - \cos 2\sqrt{\lambda_n}}$$

and the normalized eigenfunctions are given by

$$\phi_n(x) = \frac{2 \cos \sqrt{\lambda_n} x}{\sqrt{3 - \cos 2\sqrt{\lambda_n}}}.$$

6. As shown in Prob. 1, the normalized eigenfunctions are

$$\phi_n(x) = \sqrt{2} \sin \frac{(2n-1)\pi x}{2}, \quad n = 1, 2, \dots$$

Based on Eq. (34), with  $r(x) = 1$ , the coefficients in the eigenfunction expansion are given by

$$\begin{aligned} c_m &= \int_0^1 f(x) \phi_m(x) \, dx \\ &= \sqrt{2} \int_0^1 \sin \frac{(2m-1)\pi x}{2} \, dx \\ &= \frac{2\sqrt{2}}{(2m-1)\pi}. \end{aligned}$$

Therefore we obtain the formal expansion

$$1 = \frac{2\sqrt{2}}{\pi} \sum_{n=1}^{\infty} \frac{1}{2n-1} \sin \frac{(2n-1)\pi x}{2}.$$

8. We consider the normalized eigenfunctions

$$\phi_n(x) = \sqrt{2} \sin \frac{(2n-1)\pi x}{2}, \quad n = 1, 2, \dots$$

Based on Eq. (34), with  $r(x) = 1$ , the coefficients in the eigenfunction expansion are given by

$$\begin{aligned} c_m &= \int_0^1 f(x) \phi_m(x) dx \\ &= \sqrt{2} \int_0^{1/2} \sin \frac{(2m-1)\pi x}{2} dx \\ &= \frac{2\sqrt{2}}{(2m-1)\pi} \left[ 1 - \cos \frac{(2m-1)\pi}{4} \right]. \end{aligned}$$

Therefore we obtain the formal expansion

$$f(x) = \frac{2\sqrt{2}}{\pi} \sum_{n=1}^{\infty} \left[ 1 - \cos \frac{(2n-1)\pi}{4} \right] \sin \frac{(2n-1)\pi x}{2}.$$

9. The normalized eigenfunctions are

$$\phi_n(x) = \sqrt{2} \sin \frac{(2n-1)\pi x}{2}, \quad n = 1, 2, \dots$$

Based on Eq. (34), with  $r(x) = 1$ , the coefficients in the eigenfunction expansion are given by

$$\begin{aligned} c_m &= \int_0^1 f(x) \phi_m(x) dx \\ &= \sqrt{2} \int_0^{1/2} 2x \sin \frac{(2m-1)\pi x}{2} dx + \sqrt{2} \int_{1/2}^1 \sin \frac{(2m-1)\pi x}{2} dx \\ &= \frac{8}{(2m-1)^2 \pi^2} \left[ \sin \frac{m\pi}{2} - \cos \frac{m\pi}{2} \right]. \end{aligned}$$

Therefore the formal expansion of the given function is

$$f(x) = \frac{8}{\pi^2} \sum_{n=1}^{\infty} \frac{\sin \frac{n\pi}{2} - \cos \frac{n\pi}{2}}{(2n-1)^2} \sin \frac{(2n-1)\pi x}{2}.$$

11. From Prob. 4, the normalized eigenfunctions are given by

$$\phi_n(x) = \frac{2 \cos \sqrt{\lambda_n} x}{\sqrt{3 - \cos 2\sqrt{\lambda_n}}},$$



in which the eigenvalues satisfy  $\cos\sqrt{\lambda_n} - \sqrt{\lambda_n} \sin\sqrt{\lambda_n} = 0$ . Based on Eq. (34), the coefficients in the eigenfunction expansion are given by

$$\begin{aligned} c_m &= \int_0^1 f(x)\phi_m(x)dx \\ &= \frac{2}{\sqrt{3 - \cos 2\sqrt{\lambda_m}}} \int_0^1 x \cos \sqrt{\lambda_m} x dx \\ &= \frac{\sqrt{2} (2 \cos \sqrt{\lambda_m} - 1)}{\lambda_m \alpha_m}, \end{aligned}$$

in which  $\alpha_m = \sqrt{1 + \sin^2 \sqrt{\lambda_m}}$ .

12. The normalized eigenfunctions are given by

$$\phi_n(x) = \frac{2 \cos \sqrt{\lambda_n} x}{\sqrt{3 - \cos 2\sqrt{\lambda_n}}},$$

in which the eigenvalues satisfy  $\cos\sqrt{\lambda_n} - \sqrt{\lambda_n} \sin\sqrt{\lambda_n} = 0$ . Based on Eq. (34), the coefficients in the eigenfunction expansion are given by

$$\begin{aligned} c_m &= \int_0^1 f(x)\phi_m(x)dx \\ &= \frac{2}{\sqrt{3 - \cos 2\sqrt{\lambda_m}}} \int_0^1 (1-x)\cos \sqrt{\lambda_m} x dx \\ &= \frac{\sqrt{2} (1 - \cos \sqrt{\lambda_m})}{\lambda_m \alpha_m}, \end{aligned}$$

in which  $\alpha_m = \sqrt{1 + \sin^2 \sqrt{\lambda_m}}$ .

13. We consider the normalized eigenfunctions

$$\phi_n(x) = \frac{2 \cos \sqrt{\lambda_n} x}{\sqrt{3 - \cos 2\sqrt{\lambda_n}}},$$

in which the eigenvalues satisfy  $\cos\sqrt{\lambda_n} - \sqrt{\lambda_n} \sin\sqrt{\lambda_n} = 0$ . The coefficients in the eigenfunction expansion are given by

$$\begin{aligned}
 c_n &= \int_0^1 f(x)\phi_n(x)dx \\
 &= \frac{2}{\sqrt{3 - \cos 2\sqrt{\lambda_n}}} \int_0^{1/2} \cos \sqrt{\lambda_n} x dx \\
 &= \frac{\sqrt{2} \sin(\sqrt{\lambda_n}/2)}{\sqrt{\lambda_n} \alpha_n},
 \end{aligned}$$

in which  $\alpha_n = \sqrt{1 + \sin^2 \sqrt{\lambda_n}}$ .

15. The differential equation can be written as

$$[(1 + x^2)y']' + y = 0,$$

with  $p(x) = -1 - x^2$  and  $q(x) = 1$ . The boundary conditions are homogeneous and *separated*. Hence the BVP is *self-adjoint*.

16. Since the boundary conditions are *not* separated, the inner product is computed: Given  $u$  and  $v$ , sufficiently smooth and satisfying the boundary conditions,

$$\begin{aligned}
 (L[u], v) &= \int_0^1 [u''v + uv]dx \\
 &= u'v \Big|_0^1 - \int_0^1 [u'v' + uv]dx \\
 &= [u'v - uv'] \Big|_0^1 + (u, L[v]).
 \end{aligned}$$

Based on the given boundary conditions,

$$\begin{aligned}
 u'(1)v(1) - u'(0)v(0) &= u(0)v(1) + 2u(1)v(0) \\
 -u(1)v'(1) + u(0)v'(0) &= -u(1)v(0) - 2u(0)v(1).
 \end{aligned}$$

Since

$$[u'v - uv'] \Big|_0^1 = u(1)v(0) - u(0)v(1),$$

the BVP is *not* self-adjoint.

18. The differential equation can be written as

$$-[y']' = \lambda y,$$

with  $p(x) = 1$ ,  $q(x) = 0$ , and  $r(x) = 1$ . The boundary conditions are homogeneous and *separated*. Hence the BVP is *self-adjoint*.

19. If  $a_2 = 0$ , then

$$u'(1)v(1) - u(1)v'(1) = -\frac{b_2}{b_1}u'(1)v'(1) + \frac{b_2}{b_1}u'(1)v'(1) = 0,$$

and since  $u(0) = v(0) = 0$ ,

$$u'(0)v(0) - u(0)v'(0) = 0.$$

If  $b_2 = 0$ , then  $u(1) = v(1) = 0$  implies that

$$u'(1)v(1) - u(1)v'(1) = 0.$$

Furthermore,

$$u'(0)v(0) - u(0)v'(0) = -\frac{a_2}{a_1}u'(0)v'(0) + \frac{a_2}{a_1}u'(0)v'(0) = 0.$$

Clearly, the results are also true if  $a_2 = b_2 = 0$ .

20. Suppose that  $\phi_1(x)$  and  $\phi_2(x)$  are linearly independent eigenfunctions associated with an eigenvalue  $\lambda$ . The Wronskian is given by

$$W(\phi_1, \phi_2)(x) = \phi_1(x)\phi_2'(x) - \phi_2(x)\phi_1'(x).$$

Each of the eigenfunctions satisfies the boundary condition  $a_1y(0) + a_2y'(0) = 0$ . If either  $a_1 = 0$  or  $a_2 = 0$ , then clearly  $W(\phi_1, \phi_2)(0) = 0$ . On the other hand, if  $a_2$  is *not* equal to zero, then

$$\begin{aligned} W(\phi_1, \phi_2)(0) &= \phi_1(0)\phi_2'(0) - \phi_2(0)\phi_1'(0) \\ &= -\frac{a_1}{a_2}\phi_1(0)\phi_2(0) + \frac{a_1}{a_2}\phi_2(0)\phi_1(0) \\ &= 0. \end{aligned}$$

By Theorem 3.3.2,  $W(\phi_1, \phi_2)(x) = 0$  for all  $0 \leq x \leq 1$ . Based on Theorem 3.3.3,  $\phi_1(x)$  and  $\phi_2(x)$  must be linearly *dependent*. Hence  $\lambda$  must be a simple eigenvalue.

22. We consider the operator

$$L[y] = -[p(x)y']' + q(x)y$$

on the interval  $0 < x < 1$ , together with the boundary conditions

$$a_1y(0) + a_2y'(0) = 0, \quad b_1y(1) + b_2y'(1) = 0.$$

Let  $u = \phi + i\psi$  and  $v = \xi + i\eta$ . If  $u$  and  $v$  both satisfy the boundary conditions, then the real and imaginary parts also satisfy the same boundary conditions. Using the inner product

$$(u, v) = \int_0^1 u(x)\bar{v}(x)dx,$$

$$\begin{aligned}
 (L[u], v) &= \int_0^1 [-[p(x)u']'\bar{v} + q(x)u\bar{v}] dx \\
 &= \int_0^1 \{-[p(x)(\phi' + i\psi')]\bar{v} + q(x)u\bar{v}\} dx \\
 &= -p(x)(\phi' + i\psi')\bar{v}\Big|_0^1 + \int_0^1 \{p(x)(\phi' + i\psi')\bar{v}' + q(x)u\bar{v}\} dx.
 \end{aligned}$$

Integrating by parts, again,

$$\int_0^1 \{p(x)(\phi' + i\psi')\bar{v}'\} dx = (\phi + i\psi)p(x)\bar{v}'\Big|_0^1 - \int_0^1 \{[p(x)\bar{v}']'u\} dx.$$

Collecting the boundary terms,

$$p(x)[(\phi' + i\psi')\bar{v} - (\phi + i\psi)\bar{v}']\Big|_0^1 = p(x)[(\phi' + i\psi')(\xi - i\eta) - (\phi + i\psi)(\xi' - i\eta')]\Big|_0^1.$$

The *real* part is given by

$$\begin{aligned}
 p(x)[(\phi'\xi + \psi'\eta) - (\phi\xi' + \psi\eta')]\Big|_0^1 &= p(x)[(\phi'\xi - \phi\xi') + (\psi'\eta - \psi\eta')]\Big|_0^1 \\
 &= p(x)[\phi'\xi - \phi\xi']\Big|_0^1 + p(x)[\psi'\eta - \psi\eta']\Big|_0^1.
 \end{aligned}$$

Since  $\phi, \psi, \xi$  and  $\eta$  satisfy the boundary conditions, it follows that

$$p(x)[(\phi'\xi + \psi'\eta) - (\phi\xi' + \psi\eta')]\Big|_0^1 = 0.$$

Similarly, the *imaginary* part also vanishes. That is,

$$p(x)[(\psi'\xi - \psi\xi') - (\phi'\eta - \phi\eta')]\Big|_0^1 = 0.$$

Therefore

$$\begin{aligned}
 (L[u], v) &= \int_0^1 \{-[p(x)\bar{v}']'u + q(x)u\bar{v}\} dx \\
 &= (L[\bar{v}], \bar{u}) \\
 &= \overline{(\bar{u}, L[\bar{v}])}.
 \end{aligned}$$

The result follows from the fact that  $\overline{(\bar{u}, L[\bar{v}])} = (u, L[v])$ .

24. Based on the physical problem,  $\lambda = P/EI > 0$ . Let  $\lambda = \mu^2$ . The characteristic equation is  $r^4 + \mu^2 r^2 = 0$ , with roots  $r_{1,2} = 0, r_3 = -\mu i$  and  $r_4 = \mu i$ . Hence the general solution is

$$y(x) = c_1 + c_2 x + c_3 \cos \mu x + c_4 \sin \mu x.$$

(a). Simply supported on both ends :  $y(0) = y''(0) = 0$ ;  $y(L) = y''(L) = 0$ .  
Invoking the boundary conditions, we obtain the system of equations

$$\begin{aligned} c_1 + c_3 &= 0 \\ c_3 &= 0 \\ c_3 \cos \mu L + c_4 \sin \mu L &= 0 \\ c_1 + c_2 L + c_3 \cos \mu L + c_4 \sin \mu L &= 0. \end{aligned}$$

The determinantal equation is

$$\sin \mu L = 0.$$

The nonzero roots are  $\mu_n = n\pi/L$ ,  $n = 1, 2, \dots$ . Therefore the eigenfunctions are  $\phi_n = \sin \mu_n x$ , with corresponding eigenvalues  $\lambda_n = n^2\pi^2/L^2$ . Hence the smallest eigenvalue is  $\lambda_1 = \pi^2/L^2$ .

(b). Simply supported :  $y(0) = y''(0) = 0$ ; clamped :  $y(L) = y'(L) = 0$ .  
Invoking the boundary conditions, we obtain the system of equations

$$\begin{aligned} c_1 + c_3 &= 0 \\ c_3 &= 0 \\ c_2 - c_3 \mu \sin \mu L + c_4 \mu \cos \mu L &= 0 \\ c_1 + c_2 L + c_3 \cos \mu L + c_4 \sin \mu L &= 0. \end{aligned}$$

The determinantal equation is

$$\mu L \cos \mu L - \sin \mu L = 0.$$

It follows that the eigenfunctions are given by

$$\phi_n(x) = \sin \sqrt{\lambda_n} x - \left( \sqrt{\lambda_n} \cos \sqrt{\lambda_n} L \right) x,$$

and the eigenvalues satisfy the equation  $L \sqrt{\lambda_n} \cos \sqrt{\lambda_n} L - \sin \sqrt{\lambda_n} L = 0$ .  
The smallest eigenvalue is estimated as  $\lambda_1 \approx (4.4934)^2/L^2$ .

(c). Clamped :  $y(0) = y'(0) = 0$ ; clamped :  $y(L) = y'(L) = 0$ .  
Invoking the boundary conditions, we obtain the system of equations

$$\begin{aligned} c_1 + c_3 &= 0 \\ c_2 + \mu c_4 &= 0 \\ c_1 + c_2 L + c_3 \cos \mu L + c_4 \sin \mu L &= 0 \\ c_2 - c_3 \mu \sin \mu L + c_4 \mu \cos \mu L &= 0. \end{aligned}$$

The determinantal equation is

$$2 - 2 \cos \mu L = \mu L \sin \mu L.$$

It follows that the eigenfunctions are given by

$$\phi_n(x) = 1 - \cos \sqrt{\lambda_n} x,$$

and the eigenvalues satisfy the equation  $2 - 2\cos \sqrt{\lambda_n} L = \sqrt{\lambda_n} L \sin \sqrt{\lambda_n} L$ .  
The smallest eigenvalue is  $\lambda_1 = (2\pi)^2/L^2$ .

26. As shown in Prob. 25, the general solution is

$$y(x) = c_1 + c_2 x + c_3 \cos \mu x + c_4 \sin \mu x.$$

Imposing the boundary conditions, we obtain the system of equations

$$\begin{aligned} c_2 &= 0 \\ c_1 + c_3 &= 0 \\ c_2 + \mu c_4 &= 0 \\ c_3 \cos \mu L + c_4 \sin \mu L &= 0. \end{aligned}$$

For a nontrivial solution, it is necessary that

$$\cos \mu L = 0.$$

We find that  $c_2 = c_4 = 0$ , and hence the eigenfunctions are given by

$$\phi_n(x) = 1 - \cos \sqrt{\lambda_n} x.$$

The corresponding eigenvalues are  $\lambda_n = (2n - 1)^2 \pi^2 / 4L^2$ ,  $n = 1, 2, \dots$ . The smallest eigenvalue is  $\lambda_1 = \pi^2 / 4L^2$ .

### Section 11.3

4. The eigensystem of the associated homogeneous problem is given in Prob. 11 of Section 11.2. The normalized eigenfunctions are

$$\phi_n(x) = \frac{\sqrt{2} \cos \sqrt{\lambda_n} x}{\sqrt{1 + \sin^2 \sqrt{\lambda_n}}},$$

in which the eigenvalues satisfy  $\cos \sqrt{\lambda_n} - \sqrt{\lambda_n} \sin \sqrt{\lambda_n} = 0$ . Rewrite the given differential equation as  $-y'' = 2y + x$ . Since  $\mu = 2 \neq \lambda_n$ , the formal solution of the nonhomogeneous problem is

$$y(x) = \sum_{n=1}^{\infty} \frac{c_n}{\lambda_n - 2} \phi_n(x),$$

in which

$$\begin{aligned} c_n &= \int_0^1 f(x) \phi_n(x) dx \\ &= \frac{\sqrt{2}}{\sqrt{1 + \sin^2 \sqrt{\lambda_n}}} \int_0^1 x \cos \sqrt{\lambda_n} x dx \\ &= \frac{\sqrt{2}(2 \cos \sqrt{\lambda_n} - 1)}{\lambda_n \sqrt{1 + \sin^2 \sqrt{\lambda_n}}}. \end{aligned}$$

Therefore we obtain the formal expansion

$$y(x) = 2 \sum_{n=1}^{\infty} \frac{\sqrt{2}(2 \cos \sqrt{\lambda_n} - 1) \cos \sqrt{\lambda_n} x}{\lambda_n(\lambda_n - 2)(1 + \sin^2 \sqrt{\lambda_n})}.$$

5. The solution follows that in Prob. 1, except that the coefficients are given by

$$\begin{aligned} c_n &= \int_0^1 f(x) \phi_n(x) dx \\ &= \sqrt{2} \int_0^{1/2} 2x \sin n\pi x dx + \sqrt{2} \int_{1/2}^1 (2 - 2x) \sin n\pi x dx \\ &= 4 \frac{\sqrt{2} \sin(n\pi/2)}{n^2 \pi^2}. \end{aligned}$$

Therefore the formal solution is

$$y(x) = 8 \sum_{n=1}^{\infty} \frac{\sin(n\pi/2) \sin n\pi x}{n^2 \pi^2 (n^2 \pi^2 - 2)}.$$

6. The differential equation can be written as  $-y'' = \mu y + f(x)$ . Note that  $q(x) = 0$  and  $r(x) = 1$ . As shown in Prob. 1 in Section 11.2, the normalized eigenfunctions are

$$\phi_n(x) = \sqrt{2} \sin \frac{(2n-1)x}{2},$$

with associated eigenvalues  $\lambda_n = (2n-1)^2 \pi^2 / 4$ . Based on Theorem 11.3.1, the formal solution is given by

$$y(x) = \sqrt{2} \sum_{n=1}^{\infty} \frac{c_n}{(\lambda_n - \mu)} \sin \frac{(2n-1)x}{2},$$

as long as  $\mu \neq \lambda_n$ . The coefficients in the series expansion are computed as

$$c_n = \sqrt{2} \int_0^1 f(x) \sin \frac{(2n-1)x}{2} dx.$$

7. As shown in Prob. 1 in Section 11.2, the normalized eigenfunctions are

$$\phi_n(x) = \sqrt{2} \cos \frac{(2n-1)x}{2},$$

with associated eigenvalues  $\lambda_n = (2n-1)^2 \pi^2 / 4$ . Based on Theorem 11.3.1, the formal solution is given by

$$y(x) = \sqrt{2} \sum_{n=1}^{\infty} \frac{c_n}{(\lambda_n - \mu)} \cos \frac{(2n-1)x}{2},$$

as long as  $\mu \neq \lambda_n$ . The coefficients in the series expansion are computed as

$$c_n = \sqrt{2} \int_0^1 f(x) \cos \frac{(2n-1)x}{2} dx.$$

9. The normalized eigenfunctions are

$$\phi_n(x) = \frac{\sqrt{2} \cos \sqrt{\lambda_n} x}{\sqrt{1 + \sin^2 \sqrt{\lambda_n}}}.$$

The eigenvalues satisfy  $\cos \sqrt{\lambda_n} - \sqrt{\lambda_n} \sin \sqrt{\lambda_n} = 0$ . Based on Theorem 11.3.1, the formal solution is given by

$$y(x) = \sqrt{2} \sum_{n=1}^{\infty} \frac{c_n \cos \sqrt{\lambda_n} x}{(\lambda_n - \mu) \sqrt{1 + \sin^2 \sqrt{\lambda_n}}},$$

as long as  $\mu \neq \lambda_n$ . The coefficients in the series expansion are computed as



$$c_n = \frac{\sqrt{2}}{\sqrt{1 + \sin^2 \sqrt{\lambda_n}}} \int_0^1 f(x) \cos \sqrt{\lambda_n} x dx .$$

13. The differential equation can be written as  $-y'' = \pi^2 y + \cos \pi x - a$ . Note that  $\mu = \pi^2$  and  $f(x) = \cos \pi x - a$ . Furthermore,  $\mu = \pi^2$  is an eigenvalue corresponding to the eigenfunction  $\phi_1(x) = \sqrt{2} \sin \pi x$ . A solution exists only if  $f(x)$  and  $\phi_1(x)$  are *orthogonal*. Since

$$\int_0^1 (\cos \pi x - a) \sin \pi x dx = -2a/\pi ,$$

there exists a solution as long as  $a = 0$ . In that case, the ODE is

$$y'' + \pi^2 y = -\cos \pi x .$$

The complementary solution is  $y_c(x) = c_1 \cos \pi x + c_2 \sin \pi x$ . A particular solution is  $Y(x) = Ax \cos \pi x + Bx \sin \pi x$ . Using the *method of undetermined coefficients*, we find that  $A = 0$  and  $B = -1/2\pi$ . Therefore the general solution is

$$y(x) = c_1 \cos \pi x + c_2 \sin \pi x - \frac{x}{2\pi} \sin \pi x .$$

The boundary conditions require that  $c_1 = 0$ . Hence the solution of the boundary value problem is

$$y(x) = c_2 \sin \pi x - \frac{x}{2\pi} \sin \pi x .$$

15. Let  $y(x) = \phi_1(x) + \phi_2(x)$ . It follows that  $L[y] = L[\phi_1] + L[\phi_2] = f(x)$ . Also,

$$\begin{aligned} a_1 y(0) + a_2 y'(0) &= a_1 \phi_1(0) + a_1 \phi_2(0) + a_2 \phi_1'(0) + a_2 \phi_2'(0) \\ &= a_1 \phi_1(0) + a_2 \phi_1'(0) + a_1 \phi_2(0) + a_2 \phi_2'(0) \\ &= \alpha . \end{aligned}$$

Similarly, the boundary condition at  $x = 1$  is satisfied as well.

16. The complementary solution is  $y_c(x) = c_1 \cos \pi x + c_2 \sin \pi x$ . A particular solution is  $Y(x) = A + Bx$ . Using the *method of undetermined coefficients*, we find that  $A = 0$  and  $B = 1$ . Therefore the general solution is

$$y(x) = c_1 \cos \pi x + c_2 \sin \pi x + x .$$

Imposing the boundary conditions, we find that  $c_1 = 1$ . Therefore the solution of the BVP is

$$y(x) = \cos \pi x + c_2 \sin \pi x + x .$$

Now attempt to solve the problem as shown in Prob. 15. Let BVP-1 be given by

$$\begin{aligned}u'' + \pi^2 u &= \pi^2 x, \\u(0) = 0, \quad u(1) &= 0.\end{aligned}$$

The general solution of the ODE is

$$u(x) = c_1 \cos \pi x + c_2 \sin \pi x + x.$$

The boundary conditions require that  $c_1 = 0$  and  $-c_1 + 1 = 0$ . We find that BVP-1 has no solution. Let BVP-2 be given by

$$\begin{aligned}v'' + \pi^2 v &= 0, \\v(0) = 1, \quad v(1) &= 0.\end{aligned}$$

The general solution of the ODE is  $v(x) = c_1 \cos \pi x + c_2 \sin \pi x$ . Imposing the boundary conditions, we obtain  $c_1 = 1$  and  $-c_1 = 0$ . Thus BVP-2 has no solution.

17. Setting  $y(x) = u(x) + v(x)$ , substitution results in

$$\begin{aligned}u'' + v'' + p(x)[u' + v'] + q(x)[u + v] &= u'' + p(x)u' + q(x)u + \\&+ v'' + p(x)v' + q(x)v.\end{aligned}$$

Since the left hand side of the equation is *zero*,

$$u'' + p(x)u' + q(x)u = -[v'' + p(x)v' + q(x)v].$$

Furthermore,  $u(0) = y(0) - v(0) = 0$  and  $u(1) = y(1) - v(1) = 0$ . The simplest function having the assumed properties is  $v(x) = (b - a)x + a$ . In this case,

$$g(x) = (a - b)p(x) + (a - b)xq(x) - aq(x).$$

20. The associated homogeneous PDE is  $u_t = u_{xx}$ ,  $0 < x < 1$ , with

$$u_x(0, t) = 0, \quad u_x(1, t) + u(1, t) = 0 \quad \text{and} \quad u(x, 0) = 1 - x.$$

Applying the method of *separation of variables*, we obtain the eigenvalue problem  $X'' + \lambda X = 0$ , with boundary conditions  $X'(0) = 0$  and  $X'(1) + X(1) = 0$ . It was shown in Prob. 4, in Section 11.2, that the normalized eigenfunctions are

$$\phi_n(x) = \frac{\sqrt{2} \cos \sqrt{\lambda_n} x}{\sqrt{1 + \sin^2 \sqrt{\lambda_n}}},$$

where  $\cos \sqrt{\lambda_n} - \sqrt{\lambda_n} \sin \sqrt{\lambda_n} = 0$ .

We assume a solution of the form

$$u(x, t) = \sum_{n=1}^{\infty} b_n(t) \phi_n(x).$$

Substitution into the given PDE results in

$$\begin{aligned} \sum_{n=1}^{\infty} b'_n(t) \phi_n(x) &= \sum_{n=1}^{\infty} b_n(t) \phi''_n(x) + e^{-t} \\ &= - \sum_{n=1}^{\infty} \lambda_n b_n(t) \phi_n(x) + e^{-t}, \end{aligned}$$

that is,

$$\sum_{n=1}^{\infty} [b'_n(t) + \lambda_n b_n(t)] \phi_n(x) = e^{-t}.$$

We now note that

$$1 = \sum_{n=1}^{\infty} \frac{\sqrt{2} \sin \sqrt{\lambda_n}}{\sqrt{\lambda_n} \sqrt{1 + \sin^2 \sqrt{\lambda_n}}} \phi_n(x).$$

Therefore

$$e^{-t} = \sum_{n=1}^{\infty} \beta_n e^{-t} \phi_n(x),$$

in which  $\beta_n = \sqrt{2} \sin \sqrt{\lambda_n} / \left[ \sqrt{\lambda_n} \sqrt{1 + \sin^2 \sqrt{\lambda_n}} \right]$ . Combining these results,

$$\sum_{n=1}^{\infty} [b'_n(t) + \lambda_n b_n(t) - \beta_n e^{-t}] \phi_n(x) = 0.$$

Since the resulting equation is valid for  $0 < x < 1$ , it follows that

$$b'_n(t) + \lambda_n b_n(t) = \beta_n e^{-t}, \quad n = 1, 2, \dots.$$

Prior to solving the sequence of ODEs, we establish the initial conditions. These are obtained from the expansion

$$u(x, 0) = 1 - x = \sum_{n=1}^{\infty} \alpha_n \phi_n(x),$$

in which  $\alpha_n = \sqrt{2} (1 - \cos \sqrt{\lambda_n}) / \left[ \lambda_n \sqrt{1 + \sin^2 \sqrt{\lambda_n}} \right]$ . That is,  $b_n(0) = \alpha_n$ .

Therefore the solutions of the first order ODEs are

$$b_n(t) = \frac{\beta_n (e^{-t} - e^{-\lambda_n t})}{(\lambda_n - 1)} + \alpha_n e^{-\lambda_n t}, \quad n = 1, 2, \dots.$$

Hence the solution of the boundary value problem is

$$u(x, t) = \sum_{n=1}^{\infty} \left[ \frac{\beta_n (e^{-t} - e^{-\lambda_n t})}{(\lambda_n - 1)} + \alpha_n e^{-\lambda_n t} \right] \phi_n(x).$$

21. Based on the boundary conditions, the normalized eigenfunctions are given by

$$\phi_n(x) = \sqrt{2} \sin n\pi x,$$

with associated eigenvalues  $\lambda_n = n^2\pi^2$ . We now assume a solution of the form

$$u(x, t) = \sum_{n=1}^{\infty} b_n(t) \phi_n(x).$$

Substitution into the given PDE results in

$$\begin{aligned} \sum_{n=1}^{\infty} b'_n(t) \phi_n(x) &= \sum_{n=1}^{\infty} b_n(t) \phi_n''(x) + 1 - |1 - 2x| \\ &= - \sum_{n=1}^{\infty} \lambda_n b_n(t) \phi_n(x) + 1 - |1 - 2x|, \end{aligned}$$

that is,

$$\sum_{n=1}^{\infty} [b'_n(t) + \lambda_n b_n(t)] \phi_n(x) = 1 - |1 - 2x|.$$

It was shown in Prob. 5 that

$$1 - |1 - 2x| = \sum_{n=1}^{\infty} 4 \frac{\sqrt{2} \sin(n\pi/2)}{n^2\pi^2} \phi_n(x).$$

Substituting on the right hand side and collecting terms, we obtain

$$\sum_{n=1}^{\infty} \left[ b'_n(t) + \lambda_n b_n(t) - 4 \frac{\sqrt{2} \sin(n\pi/2)}{n^2\pi^2} \right] \phi_n(x) = 0.$$

Since the resulting equation is valid for  $0 < x < 1$ , it follows that

$$b'_n(t) + n^2\pi^2 b_n(t) = 4 \frac{\sqrt{2} \sin(n\pi/2)}{n^2\pi^2}, \quad n = 1, 2, \dots$$

Based on the given initial condition, we also have  $b_n(0) = 0$ , for  $n = 1, 2, \dots$ . The solutions of the first order ODEs are

$$b_n(t) = 4 \frac{\sqrt{2} \sin(n\pi/2)}{n^4\pi^4} (1 - e^{-n^2\pi^2 t}), \quad n = 1, 2, \dots$$

Hence the solution of the boundary value problem is

$$u(x, t) = \frac{8}{\pi^4} \sum_{n=1}^{\infty} \frac{\sin(n\pi/2)}{n^4} (1 - e^{-n^2\pi^2 t}) \sin n\pi x.$$

23(a). Let  $u(x, t)$  be a solution of the boundary value problem and  $v(x)$  be a solution of the related BVP. Substituting for  $u(x, t) = w(x, t) + v(x)$ , we have

$$r(x)u_t = r(x)w_t$$

and

$$\begin{aligned} [p(x)u_x]_x - q(x)u + F(x) &= [p(x)w_x]_x - q(x)w + [p(x)v']' - q(x)v + F(x) \\ &= [p(x)w_x]_x - q(x)w - F(x) + F(x) \\ &= [p(x)w_x]_x - q(x)w. \end{aligned}$$

Hence  $w(x, t)$  is a solution of the *homogeneous* PDE

$$r(x)w_t = [p(x)w_x]_x - q(x)w.$$

The required *boundary conditions* are

$$\begin{aligned} w(0, t) &= u(0, t) - v(0) = 0, \\ w(1, t) &= u(1, t) - v(1) = 0. \end{aligned}$$

The associated *initial condition* is  $w(x, 0) = u(x, 0) - v(x) = f(x) - v(x)$ .

(b). Let  $v(x)$  be a solution of the ODE

$$[p(x)v']' - q(x)v = -F(x),$$

and satisfying the boundary conditions  $v'(0) - h_1v(0) = T_1$ ,  $v'(1) + h_2v(1) = T_2$ . If  $w(x, t) = u(x, t) - v(x)$ , then it is easy to show the  $w$  satisfies the PDE and initial condition given in Part (a). Furthermore,

$$\begin{aligned} w_x(0, t) - h_1w(0, t) &= u_x(0, t) - v'(0) - h_1u(0, t) + h_1v(0) \\ &= u_x(0, t) - h_1u(0, t) - v'(0) + h_1v(0) \\ &= 0. \end{aligned}$$

Similarly, the other boundary condition is also homogeneous.

25. In this problem,  $F(x) = -\pi^2 \cos \pi x$ . First find a solution of the boundary value problem

$$v'' = \pi^2 \cos \pi x, \quad v'(0) = 0, \quad v(1) = 1.$$

The general solution is  $v(x) = Ax + B - \cos \pi x$ . Imposing the initial conditions, the solution of the related BVP is  $v(x) = -\cos \pi x$ . Now let  $w(x, t) = u(x, t) + \cos \pi x$ . It follows that  $w(x, t)$  satisfies the *homogeneous* boundary value problem, and the initial condition  $w(x, 0) = \cos(3\pi x/2) - \cos \pi x - (-\cos \pi x) = \cos(3\pi x/2)$ .

We now seek solutions of the homogeneous problem of the form

$$w(x, t) = \sum_{n=1}^{\infty} b_n(t) \phi_n(x),$$

in which  $\phi_n(x) = \sqrt{2} \cos(2n-1)\pi x/2$  are the *normalized* eigenfunctions of the *homogeneous* problem and  $\lambda_n = (2n-1)^2 \pi^2/4$ , with  $n = 1, 2, \dots$ . Substitution into the PDE for  $w$ , we have

$$\begin{aligned} \sum_{n=1}^{\infty} b'_n(t) \phi_n(x) &= \sum_{n=1}^{\infty} b_n(t) \phi_n''(x) \\ &= - \sum_{n=1}^{\infty} \lambda_n b_n(t) \phi_n(x). \end{aligned}$$

Since the latter equation is valid for  $0 < x < 1$ , it follows that

$$b'_n(t) + \lambda_n b_n(t) = 0, \quad n = 1, 2, \dots,$$

with  $b_n(t) = b_n(0) \exp(-\lambda_n t)$ . Hence

$$w(x, t) = \sum_{n=1}^{\infty} b_n(0) \exp(-\lambda_n t) \phi_n(x).$$

Imposing the initial condition, we require that

$$\sqrt{2} \sum_{n=1}^{\infty} b_n(0) \cos \frac{(2n-1)\pi x}{2} = \cos \frac{3\pi x}{2}.$$

It is evident that all of the coefficients are *zero*, except for  $b_2(0) = 1/\sqrt{2}$ . Therefore

$$w(x, t) = \exp(-9\pi^2 t/4) \cos \frac{3\pi x}{2},$$

and the solution of the original BVP is

$$u(x, t) = \exp(-9\pi^2 t/4) \cos \frac{3\pi x}{2} - \cos \pi x.$$

26(a). Let  $u(x, t) = X(x)T(t)$ . Substituting into the homogeneous form of (i),

$$r(x)XT'' = [p(x)X']'T - q(x)XT.$$

Now divide both sides of the resulting equation by  $XT$  to obtain

$$\frac{T''}{T} = \frac{[p(x)X']'}{r(x)X} - \frac{q(x)}{r(x)} = -\lambda.$$

It follows that

$$-[p(x)X']' + q(x)X = \lambda r(x)X.$$

Since the boundary conditions (ii) are valid for all  $t > 0$ , we also have

$$X'(0) - h_1X(0) = 0, \quad X'(1) + h_2X(1) = 0.$$

(b). Let  $\lambda_n$  and  $\phi_n(x)$  denote the eigenvalues and eigenfunctions of the BVP in Part (a). Assume a solution, of the PDE (i), of the form

$$u(x, t) = \sum_{n=1}^{\infty} b_n(t)\phi_n(x).$$

Substituting into (i),

$$\begin{aligned} r(x) \sum_{n=1}^{\infty} b_n''(t)\phi_n &= \sum_{n=1}^{\infty} b_n(t) \{ [p(x)\phi_n']' - q(x)\phi_n \} + F(x, t) \\ &= \sum_{n=1}^{\infty} b_n(t) [ -\lambda_n r(x)\phi_n ] + F(x, t). \end{aligned}$$

Rearranging the terms,

$$r(x) \sum_{n=1}^{\infty} [b_n''(t) + \lambda_n b_n(t)]\phi_n = F(x, t),$$

or

$$\sum_{n=1}^{\infty} [b_n''(t) + \lambda_n b_n(t)]\phi_n = \frac{F(x, t)}{r(x)}.$$

Now expand the right hand side in terms of the eigenfunctions. That is, write

$$\frac{F(x, t)}{r(x)} = \sum_{n=1}^{\infty} \gamma_n(t)\phi_n(x),$$

in which

$$\begin{aligned}\gamma_n(t) &= \int_0^1 r(x) \frac{F(x, t)}{r(x)} \phi_n(x) dx \\ &= \int_0^1 F(x, t) \phi_n(x) dx, \quad n = 1, 2, \dots.\end{aligned}$$

Combining these results, we have

$$\sum_{n=1}^{\infty} [b_n''(t) + \lambda_n b_n(t) - \gamma_n(t)] \phi_n = 0.$$

It follows that

$$b_n''(t) + \lambda_n b_n(t) = \gamma_n(t), \quad n = 1, 2, \dots.$$

In order to solve this sequence of ODEs, we require initial conditions  $b_n(0)$  and  $b_n'(0)$ . Note that

$$u(x, 0) = \sum_{n=1}^{\infty} b_n(0) \phi_n(x) \quad \text{and} \quad u_t(x, 0) = \sum_{n=1}^{\infty} b_n'(0) \phi_n(x).$$

Based on the given initial conditions,

$$f(x) = \sum_{n=1}^{\infty} b_n(0) \phi_n(x) \quad \text{and} \quad g(x) = \sum_{n=1}^{\infty} b_n'(0) \phi_n(x).$$

Hence  $b_n(0) = \alpha_n$  and  $b_n'(0) = \beta_n$ , the expansion coefficients for  $f(x)$  and  $g(x)$  in terms of the eigenfunctions,  $\phi_n(x)$ .

27(a). Since the eigenvectors are *orthogonal*, they form a basis. Given any vector  $\mathbf{b}$ ,

$$\mathbf{b} = \sum_{i=1}^n b_i \boldsymbol{\xi}^{(i)}.$$

Taking the inner product, with  $\boldsymbol{\xi}^{(j)}$ , of both sides of the equation, we have

$$(\mathbf{b}, \boldsymbol{\xi}^{(j)}) = b_j (\boldsymbol{\xi}^{(j)}, \boldsymbol{\xi}^{(j)}).$$

(b). Consider solutions of the form

$$\mathbf{x} = \sum_{i=1}^n a_i \boldsymbol{\xi}^{(i)}.$$

Substituting into Eq. (i), and using the above form of  $\mathbf{b}$ ,

$$\sum_{i=1}^n a_i \mathbf{A} \boldsymbol{\xi}^{(i)} - \sum_{i=1}^n \mu a_i \boldsymbol{\xi}^{(i)} = \sum_{i=1}^n b_i \boldsymbol{\xi}^{(i)}.$$

It follows that



$$\sum_{i=1}^n [a_i \lambda_i - \mu a_i - b_i] \xi^{(i)} = \mathbf{0}.$$

Since the eigenvectors are linearly independent,

$$a_i \lambda_i - \mu a_i - b_i = 0, \text{ for } i = 1, 2, \dots, n.$$

That is,

$$a_i = b_i / (\lambda_i - \mu), \quad i = 1, 2, \dots, n.$$

Assuming that the eigenvectors are *normalized*, the solution is given by

$$\mathbf{x} = \sum_{i=1}^n \frac{(\mathbf{b}, \xi^{(i)})}{\lambda_i - \mu} \xi^{(i)},$$

as long as  $\mu$  is *not* equal to one of the eigenvalues.

29. First write the ODE as  $y'' + y = -f(x)$ . A fundamental set of solutions of the homogeneous equation is given by

$$y_1 = \cos x \text{ and } y_2 = \sin x.$$

The Wronskian is equal to  $W[\cos x, \sin x] = 1$ . Applying the method of *variation of parameters*, a particular solution is

$$Y(x) = y_1(x)u_1(x) + y_2(x)u_2(x),$$

in which

$$u_1(x) = \int_0^x \sin(s)f(s)ds \text{ and } u_2(x) = -\int_0^x \cos(s)f(s)ds.$$

Therefore the general solution is

$$y = \phi(x) = c_1 \cos x + c_2 \sin x + \cos x \int_0^x \sin(s)f(s)ds - \sin x \int_0^x \cos(s)f(s)ds.$$

Imposing the boundary conditions, we must have  $c_1 = 0$  and

$$c_2 \sin 1 + \cos 1 \int_0^1 \sin(s)f(s)ds - \sin 1 \int_0^1 \cos(s)f(s)ds = 0.$$

It follows that

$$c_2 = \frac{1}{\sin 1} \int_0^1 \sin(1-s)f(s)ds,$$

and

$$\phi(x) = \frac{\sin x}{\sin 1} \int_0^1 \sin(1-s)f(s)ds - \int_0^x \sin(x-s)f(s)ds.$$

Using standard identities,

$$\sin x \cdot \sin(1-s) - \sin 1 \cdot \sin(x-s) = \sin s \cdot \sin(1-x).$$

Therefore

$$\frac{\sin x \cdot \sin(1-s)}{\sin 1} - \sin(x-s) = \frac{\sin s \cdot \sin(1-x)}{\sin 1}.$$

Splitting up the *first* integral, we obtain

$$\begin{aligned} \phi(x) &= \int_0^x \frac{\sin s \cdot \sin(1-x)}{\sin 1} f(s)ds + \int_x^1 \frac{\sin x \cdot \sin(1-s)}{\sin 1} f(s)ds \\ &= \int_0^1 G(x, s)f(s)ds, \end{aligned}$$

in which

$$G(x, s) = \begin{cases} \frac{\sin s \cdot \sin(1-x)}{\sin 1}, & 0 \leq s \leq x \\ \frac{\sin x \cdot \sin(1-s)}{\sin 1}, & x \leq s \leq 1. \end{cases}$$

31. The general solution of the homogeneous problem is

$$y = c_1 + c_2 x.$$

By inspection, it is easy to see that  $y_1(x) = 1$  satisfies the BC  $y'(0) = 0$  and that the function  $y_2(x) = 1 - x$  satisfies the BC  $y(1) = 0$ . The Wronskian of these solutions is  $W[y_1, y_2] = -1$ . Based on Prob. 30, with  $p(x) = 1$ , the Green's function is given by

$$G(x, s) = \begin{cases} (1-x), & 0 \leq s \leq x \\ (1-s), & x \leq s \leq 1. \end{cases}$$

Therefore the solution of the given BVP is

$$\phi(x) = \int_0^x (1-x)f(s)ds + \int_x^1 (1-s)f(s)ds.$$

32. The general solution of the homogeneous problem is

$$y = c_1 + c_2 x.$$

We find that  $y_1(x) = x$  satisfies the BC  $y(0) = 0$ . Imposing the boundary condition

$y(1) + y'(1) = 0$ , we must have  $c_1 + 2c_2 = 0$ . Hence choose  $y_2(x) = -2 + x$ . The Wronskian of these solutions is  $W[y_1, y_2] = 2$ . Based on Prob. 30, with  $p(x) = 1$ , the Green's function is given by

$$G(x, s) = \begin{cases} s(x-2)/2, & 0 \leq s \leq x \\ x(s-2)/2, & x \leq s \leq 1. \end{cases}$$

Therefore the solution of the given BVP is

$$\phi(x) = \frac{1}{2} \int_0^x s(x-2)f(s)ds + \frac{1}{2} \int_x^1 x(s-2)f(s)ds.$$

34. The general solution of the homogeneous problem is

$$y = c_1 + c_2 x.$$

By inspection, it is easy to see that  $y_1(x) = x$  satisfies the BC  $y(0) = 0$  and that the function  $y_2(x) = 1$  satisfies the BC  $y'(1) = 0$ . The Wronskian of these solutions is  $W[y_1, y_2] = -1$ . Based on Prob. 30, with  $p(x) = 1$ , the Green's function is given by

$$G(x, s) = \begin{cases} s, & 0 \leq s \leq x \\ x, & x \leq s \leq 1. \end{cases}$$

Therefore the solution of the given BVP is

$$\phi(x) = \int_0^x s f(s) ds + \int_x^1 x f(s) ds.$$

35(a). We proceed to show that if the expression given by Eq. (iv) is substituted into the integral of Eq. (iii), then the result is the solution of the nonhomogeneous problem. As long as we can interchange the summation and integration,

$$\begin{aligned} y = \phi(x) &= \int_0^1 G(x, s, \mu) f(s) ds \\ &= \sum_{n=1}^{\infty} \frac{\phi_i(x)}{\lambda_i - \mu} \int_0^1 f(s) \phi_i(s) ds. \end{aligned}$$

Note that

$$\int_0^1 f(s) \phi_i(s) ds = c_i.$$

Therefore

$$y = \phi(x) = \sum_{n=1}^{\infty} \frac{c_i \phi_i(x)}{\lambda_i - \mu},$$

as given by Eq. (13) in the text. It is assumed that the eigenfunctions are *normalized* and  $\lambda_i \neq \mu$ .

(b). For any fixed value of  $x$ ,  $G(x, s, \mu)$  is a function of  $s$  and the parameter  $\mu$ . With appropriate assumptions on  $G$ , we can write the eigenfunction expansion

$$G(x, s, \mu) = \sum_{i=1}^{\infty} a_i(x, \mu) \phi_i(s).$$

Since the eigenfunctions are *orthonormal* with respect to  $r(x)$ ,

$$\int_0^1 G(x, s, \mu) r(s) \phi_i(s) ds = a_i(x, \mu).$$

Now let

$$y_i(x) = \int_0^1 G(x, s, \mu) r(s) \phi_i(s) ds.$$

Based on the association  $f(x) = r(x) \phi_i(x)$ , it is evident that

$$L[y_i] = \mu r(x) y_i(x) + r(x) \phi_i(x).$$

In order to evaluate the left hand side, we consider the eigenfunction expansion

$$y_i(x) = \sum_{k=1}^{\infty} b_{ik} \phi_k(x).$$

It follows that

$$\begin{aligned} L[y_i] &= \sum_{k=1}^{\infty} b_{ik} L[\phi_k] \\ &= \sum_{k=1}^{\infty} b_{ik} \lambda_k r(x) \phi_k(x). \end{aligned}$$

Therefore

$$r(x) \sum_{k=1}^{\infty} b_{ik} \lambda_k \phi_k(x) = \mu r(x) \sum_{k=1}^{\infty} b_{ik} \phi_k(x) + r(x) \phi_i(x),$$

and since  $r(x) \neq 0$ ,

$$\sum_{k=1}^{\infty} b_{ik} \lambda_k \phi_k(x) = \mu \sum_{k=1}^{\infty} b_{ik} \phi_k(x) + \phi_i(x).$$

Rearranging the terms, we find that

$$\phi_i(x) = \sum_{k=1}^{\infty} b_{ik}(\lambda_k - \mu)\phi_k(x).$$

Since the eigenfunctions are linearly independent,  $b_{ik}(\lambda_k - \mu) = \delta_{ik}$ , and thus

$$y_i(x) = \sum_{k=1}^{\infty} \frac{\delta_{ik}}{\lambda_k - \mu} \phi_k(x) = \frac{1}{\lambda_i - \mu} \phi_i(x).$$

We conclude that

$$a_i(x, \mu) = \frac{1}{\lambda_i - \mu} \phi_i(x),$$

which verifies that

$$G(x, s, \mu) = \sum_{i=1}^{\infty} \frac{\phi_i(x)\phi_i(s)}{\lambda_i - \mu}.$$

36. First note that  $-d^2y/ds^2 = 0$  for  $s \neq x$ . On the interval  $0 < s < x$ , the solution of the ODE is  $y_1(s) = c_1 + c_2s$ . Given that  $y(0) = 0$ , we have  $y_1(s) = c_2s$ . On the interval  $x < s < 1$ , the solution is  $y_2(s) = d_1 + d_2s$ . Imposing the condition  $y(1) = 0$ , we have  $y_2(s) = d_1(1 - s)$ . Assuming continuity of the solution, at  $s = x$ ,

$$c_2x = d_1(1 - x),$$

which gives  $c_2 = d_1(1 - x)/x$ . Next, integrate both sides of the given ODE over an *infinitesimal* interval containing  $s = x$ :

$$-\int_{x^-}^{x^+} \frac{d^2y}{ds^2} ds = \int_{x^-}^{x^+} \delta(s - x) ds = 1.$$

It follows that

$$y'(x^-) - y'(x^+) = 1,$$

and hence  $c_2 - (-d_1) = 1$ . Solving for the two coefficients, we obtain  $c_2 = 1 - x$  and  $d_1 = x$ . Therefore the solution of the BVP is given by

$$y(s) = \begin{cases} s(1 - x), & 0 \leq s \leq x \\ x(1 - s), & x \leq s \leq 1, \end{cases}$$

which is identical to the Green's function in Prob. 28.

### Section 11.4

1. Let  $\phi_n(x) = J_0(\sqrt{\lambda_n} x)$  be the eigenfunctions of the singular problem

$$\begin{aligned} -(x y')' &= \lambda x y, \quad 0 < x < 1, \\ y, y' &\text{ bounded as } x \rightarrow 0, \quad y(1) = 0. \end{aligned}$$

Let  $\phi(x)$  be a solution of the given BVP, and set

$$\phi(x) = \sum_{n=0}^{\infty} b_n \phi_n(x). \quad (*)$$

Then

$$\begin{aligned} -(x \phi')' &= \mu x \phi + f(x) \\ &= \mu x \phi + x \frac{f(x)}{x}. \end{aligned}$$

Substituting (\*), we obtain

$$\sum_{n=0}^{\infty} b_n \lambda_n x \phi_n(x) = \mu x \sum_{n=0}^{\infty} b_n \phi_n(x) + x \sum_{n=0}^{\infty} c_n \phi_n(x),$$

in which the  $c_n$  are the expansion coefficients of  $f(x)/x$  for  $x > 0$ . That is,

$$\begin{aligned} c_n &= \frac{1}{\|\phi_n(x)\|^2} \int_0^1 x \frac{f(x)}{x} \phi_n(x) dx \\ &= \frac{1}{\|\phi_n(x)\|^2} \int_0^1 f(x) \phi_n(x) dx. \end{aligned}$$

It follows that if  $x \neq 0$ ,

$$\sum_{n=0}^{\infty} [c_n - b_n(\lambda_n - \mu)] \phi_n(x) = 0.$$

As long as  $\mu \neq \lambda_n$ , linear independence of the eigenfunctions implies that

$$b_n = \frac{c_n}{\lambda_n - \mu}, \quad n = 1, 2, \dots$$

Therefore a formal solution is given by

$$\phi(x) = \sum_{n=0}^{\infty} \frac{c_n}{\lambda_n - \mu} J_0(\sqrt{\lambda_n} x),$$

in which  $\sqrt{\lambda_n}$  are the positive roots of  $J_0(x) = 0$ .

3(a). Setting  $t = \sqrt{\lambda} x$ , it follows that

$$\frac{dy}{dx} = \sqrt{\lambda} \frac{dy}{dt} \quad \text{and} \quad \frac{d^2y}{dx^2} = \lambda \frac{d^2y}{dt^2}.$$

The given ODE can be expressed as

$$-\sqrt{\lambda} \frac{d}{dt} \left( \frac{t}{\sqrt{\lambda}} \sqrt{\lambda} \frac{dy}{dt} \right) + \frac{k^2 \sqrt{\lambda}}{t} = \sqrt{\lambda} t y,$$

or

$$-\frac{d}{dt} \left( t \frac{dy}{dt} \right) + \frac{k^2}{t} = t y.$$

An equivalent form is given by

$$t^2 \frac{dy}{dt} + t \frac{dy}{dt} + (t^2 - k^2)y = 0,$$

which is known as a Bessel equation of order  $k$ . A *bounded* solution is  $J_k(t)$ .

(b).  $J_k(\sqrt{\lambda} x)$  satisfies the boundary condition at  $x = 0$ . Imposing the other boundary

condition, it is necessary that  $J_k(\sqrt{\lambda}) = 0$ . Therefore the eigenvalues are given by  $\lambda_n$ ,  $n = 1, 2, \dots$ , where  $\sqrt{\lambda_n}$  are the positive zeroes of  $J_k(x)$ . The eigenfunctions of the BVP are  $\phi_n(x) = J_k(\sqrt{\lambda_n} x)$ .

(c). The BVP is a *singular Sturm-Liouville* problem with

$$L[y] = -(xy')' + \frac{k^2}{x} y \quad \text{and} \quad r(x) = 1.$$

We note that

$$\begin{aligned} \lambda_n \int_0^1 x \phi_n(x) \phi_m(x) dx &= \int_0^1 L[\phi_n] \phi_m(x) dx \\ &= \int_0^1 \phi_n(x) L[\phi_m] dx \\ &= \lambda_m \int_0^1 x \phi_n(x) \phi_m(x) dx. \end{aligned}$$

Therefore

$$(\lambda_n - \lambda_m) \int_0^1 x \phi_n(x) \phi_m(x) dx = 0.$$

So for  $n \neq m$ , we have  $\lambda_n \neq \lambda_m$  and

$$\int_0^1 x \phi_n(x) \phi_m(x) dx = 0.$$

(d). Consider the expansion

$$f(x) = \sum_{n=0}^{\infty} a_n \phi_n(x).$$

Multiplying both sides of equation by  $x \phi_j(x)$  and integrating from 0 to 1, and using the orthogonality of the eigenfunction,

$$\begin{aligned} \int_0^1 x f(x) \phi_j(x) dx &= \sum_{n=0}^{\infty} a_n \int_0^1 x \phi_j(x) \phi_n(x) dx \\ &= a_j \int_0^1 x \phi_j(x) \phi_j(x) dx. \end{aligned}$$

Therefore

$$a_j = \int_0^1 x f(x) \phi_j(x) dx / \int_0^1 x [\phi_j(x)]^2 dx, \quad j = 1, 2, \dots.$$

(e). Let  $\phi(x)$  be a solution of the given BVP, and set

$$\phi(x) = \sum_{n=0}^{\infty} b_n \phi_n(x), \tag{*}$$

where  $\phi_n(x) = J_k(\sqrt{\lambda_n} x)$ . Then

$$\begin{aligned} L[\phi] &= \mu x \phi + f(x) \\ &= \mu x \phi + x \frac{f(x)}{x}. \end{aligned}$$

Substituting (\*), we obtain

$$\sum_{n=0}^{\infty} b_n \lambda_n x \phi_n(x) = \mu x \sum_{n=0}^{\infty} b_n \phi_n(x) + x \sum_{n=0}^{\infty} c_n \phi_n(x),$$

in which the  $c_n$  are the expansion coefficients of  $f(x)/x$  for  $x > 0$ . That is,

$$\begin{aligned} c_n &= \frac{1}{\|\phi_n(x)\|^2} \int_0^1 x \frac{f(x)}{x} \phi_n(x) dx \\ &= \frac{1}{\|J_k(\sqrt{\lambda_n} x)\|^2} \int_0^1 f(x) J_k(\sqrt{\lambda_n} x) dx. \end{aligned}$$



It follows that if  $x \neq 0$ ,

$$\sum_{n=0}^{\infty} [c_n - b_n(\lambda_n - \mu)] J_k(\sqrt{\lambda_n} x) = 0.$$

As long as  $\mu \neq \lambda_n$ , linear independence of the eigenfunctions implies that

$$b_n = \frac{c_n}{\lambda_n - \mu}, \quad n = 1, 2, \dots.$$

Therefore a formal solution is given by

$$\phi(x) = \sum_{n=0}^{\infty} \frac{c_n}{\lambda_n - \mu} J_k(\sqrt{\lambda_n} x).$$

5(a). Setting  $\lambda = \alpha^2$  in Prob. 15 of Section 11.1, the *Chebyshev equation* can also be written as

$$-\left[\sqrt{1-x^2} y'\right]' = \frac{\lambda}{\sqrt{1-x^2}} y.$$

Note that

$$p(x) = \sqrt{1-x^2}, \quad q(x) = 0, \quad \text{and} \quad r(x) = 1/\sqrt{1-x^2},$$

hence both boundary points are singular.

(b). Observe that  $p(1-\varepsilon) = \sqrt{2\varepsilon - \varepsilon^2}$  and  $p(-1+\varepsilon) = \sqrt{2\varepsilon - \varepsilon^2}$ . It follows that if  $u(x)$  and  $v(x)$  satisfy the boundary conditions (iii), then

$$\lim_{\varepsilon \rightarrow 0^+} p(1-\varepsilon)[u'(1-\varepsilon)v(1-\varepsilon) - u(1-\varepsilon)v'(1-\varepsilon)] = 0$$

and

$$\lim_{\varepsilon \rightarrow 0^+} p(-1+\varepsilon)[u'(-1+\varepsilon)v(-1+\varepsilon) - u(-1+\varepsilon)v'(-1+\varepsilon)] = 0.$$

Therefore Eq. (17) is satisfied and the boundary value problem is *self-adjoint*.

(c). For  $n \neq 0$ ,

$$\begin{aligned} n^2 \int_{-1}^1 \frac{T_0(x) T_n(x)}{\sqrt{1-x^2}} dx &= \int_{-1}^1 T_0(x) L[T_n] dx \\ &= \int_{-1}^1 L[T_0] T_n(x) dx \\ &= 0, \end{aligned}$$

since  $L[T_0] = 0 \cdot T_0 = 0$ . Otherwise,

$$\begin{aligned}n^2 \int_{-1}^1 \frac{T_n(x) T_m(x)}{\sqrt{1-x^2}} dx &= \int_{-1}^1 L[T_n] T_m(x) dx \\ &= \int_{-1}^1 T_n(x) L[T_m] dx \\ &= m^2 \int_{-1}^1 \frac{T_n(x) T_m(x)}{\sqrt{1-x^2}} dx.\end{aligned}$$

Therefore

$$(n^2 - m^2) \int_{-1}^1 \frac{T_n(x) T_m(x)}{\sqrt{1-x^2}} dx = 0.$$

So for  $n \neq m$ ,

$$\int_{-1}^1 \frac{T_n(x) T_m(x)}{\sqrt{1-x^2}} dx = 0.$$

### Section 11.5

3. The equations relating to this problem are given by Eqs. (2) to (17) in the text. Based on the boundary conditions, the eigenfunctions are  $\phi_n(x) = J_0(\lambda_n r)$  and the associated eigenvalues  $\lambda_1, \lambda_2, \dots$  are the positive zeroes of  $J_0(\lambda)$ . The general solution has the form

$$u(r, t) = \sum_{n=1}^{\infty} [c_n J_0(\lambda_n r) \cos \lambda_n a t + k_n J_0(\lambda_n r) \sin \lambda_n a t].$$

The initial conditions require that

$$u(r, 0) = \sum_{n=1}^{\infty} c_n J_0(\lambda_n r) = f(r)$$

and

$$u_t(r, 0) = \sum_{n=1}^{\infty} a \lambda_n k_n J_0(\lambda_n r) = g(r).$$

The coefficients  $c_n$  and  $k_n$  are obtained from the respective eigenfunction expansions. That is,

$$c_n = \frac{1}{\|J_0(\lambda_n r)\|^2} \int_0^1 r f(r) J_0(\lambda_n r) dr$$

and

$$k_n = \frac{1}{a \lambda_n \|J_0(\lambda_n r)\|^2} \int_0^1 r g(r) J_0(\lambda_n r) dr,$$

in which

$$\|J_0(\lambda_n r)\|^2 = \int_0^1 r [J_0(\lambda_n r)]^2 dr$$

for  $n = 1, 2, \dots$ .

8. A more general equation was considered in Prob. 23 of Section 10.5. Assuming a solution of the form  $u(r, t) = R(r)T(t)$ , substitution into the PDE results in

$$\alpha^2 \left[ R'' T + \frac{1}{r} R' T \right] = R T'.$$

Dividing both sides of the equation by the factor  $RT$ , we obtain

$$\frac{R''}{R} + \frac{1}{r} \frac{R'}{R} = \frac{T'}{\alpha^2 T}.$$

Since both sides of the resulting differential equation depend on *different* variables, each side must be equal to a constant, say  $-\lambda^2$ . That is,

$$\frac{R''}{R} + \frac{1}{r} \frac{R'}{R} = \frac{T'}{\alpha^2 T} = -\lambda^2.$$

It follows that  $T' + \alpha^2 \lambda^2 T = 0$ , and

$$\frac{R''}{R} + \frac{1}{r} \frac{R'}{R} = -\lambda^2,$$

which can be written as  $r^2 R'' + r R' + \lambda^2 r^2 R = 0$ . Introducing the variable  $\xi = \lambda r$ , the last equation can be expressed as  $\xi^2 R'' + \xi R' + \xi^2 R = 0$ , which is the Bessel equation of order zero.

The temporal equation has solutions which are multiples of  $T(t) = \exp(-\alpha^2 \lambda^2 t)$ . The general solution of the Bessel equation is

$$R(r) = b_1 J_0(\lambda_n r) + b_2 Y_0(\lambda_n r).$$

Since the steady state temperature will be *zero*, all solutions must be bounded, and hence we set  $b_2 = 0$ . Furthermore, the boundary condition  $u(1, t) = 0$  requires that  $R(1) = 0$  and hence  $J_0(\lambda) = 0$ . It follows that the eigenfunctions are  $\phi_n(x) = J_0(\lambda_n r)$ , with the associated eigenvalues  $\lambda_1, \lambda_2, \dots$ , which are the positive zeroes of  $J_0(\lambda)$ . Therefore the fundamental solutions of the PDE are  $u_n(r, t) = J_0(\lambda_n r) \exp(-\alpha^2 \lambda_n^2 t)$ , and the general solution has the form

$$u(r, t) = \sum_{n=1}^{\infty} c_n J_0(\lambda_n r) \exp(-\alpha^2 \lambda_n^2 t).$$

The initial condition requires that

$$u(r, 0) = \sum_{n=1}^{\infty} c_n J_0(\lambda_n r) = f(r).$$

The coefficients in the general solution are obtained from the eigenfunction expansion of  $f(r)$ . That is,

$$c_n = \frac{1}{\|J_0(\lambda_n r)\|^2} \int_0^1 r f(r) J_0(\lambda_n r) dr,$$

in which

$$\|J_0(\lambda_n r)\|^2 = \int_0^1 r [J_0(\lambda_n r)]^2 dr \quad (n = 1, 2, \dots).$$

**Section 11.6**

1. The *sine expansion* of  $f(x) = 1$ , on  $0 < x < 1$ , is given by

$$f(x) = 2 \sum_{m=1}^{\infty} \frac{1 - \cos m\pi}{m\pi} \sin m\pi x,$$

with partial sums

$$S_n(x) = 2 \sum_{m=1}^n \frac{1 - \cos m\pi}{m\pi} \sin m\pi x.$$

The *mean square error* in this problem is

$$R_n = \int_0^1 |1 - S_n(x)|^2 dx.$$

Several values are shown in the Table :

$n$	5	10	15	20
$R_n$	0.067	0.04	0.026	0.02

Further numerical calculation shows that  $R_n < 0.02$  for  $n \geq 21$ .

3(a). The *sine expansion* of  $f(x) = x(1 - x)$ , on  $0 < x < 1$ , is given by

$$f(x) = 2 \sum_{m=1}^{\infty} \frac{1 - \cos m\pi}{m\pi} \sin m\pi x,$$

with partial sums

$$S_n(x) = 4 \sum_{m=1}^n \frac{1 - \cos m\pi}{m^3\pi^3} \sin m\pi x.$$

(b, c). The *mean square error* in this problem is

$$R_n = \int_0^1 |x(1 - x) - S_n(x)|^2 dx.$$

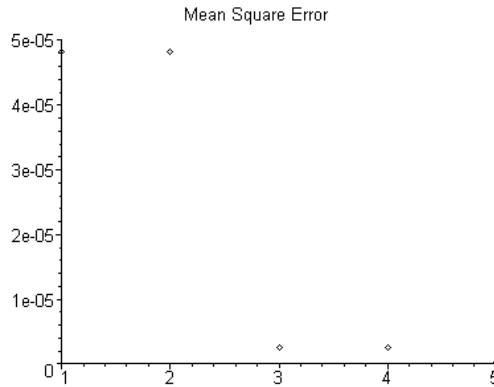

We find that  $R_1 = 0.000048$ . The graphs of  $f(x)$  and  $S_1(x)$  are plotted below :

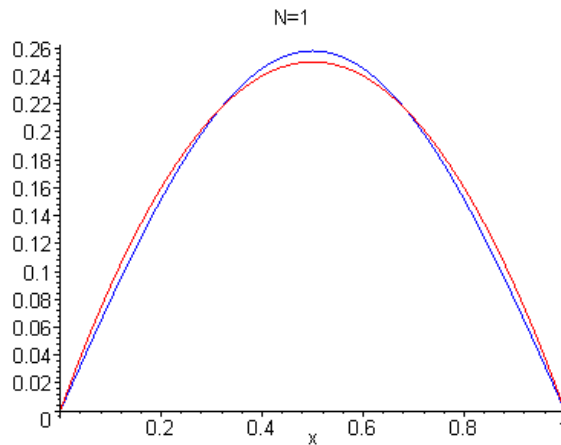

6(a). The function is bounded on intervals not containing  $x = 0$ , so for  $\varepsilon > 0$ ,

$$\int_{\varepsilon}^1 f(x)dx = \int_{\varepsilon}^1 x^{-1/2} dx = 2 - 2\sqrt{\varepsilon}.$$

Hence the improper integral is evaluated as

$$\int_0^1 f(x)dx = \lim_{\varepsilon \rightarrow 0^+} \int_{\varepsilon}^1 x^{-1/2} dx = 2.$$

On the other hand,  $f^2(x) = 1/x$  for  $x \neq 0$ , and

$$\int_{\varepsilon}^1 f^2(x)dx = \int_{\varepsilon}^1 x^{-1} dx = -\ln \sqrt{\varepsilon}.$$

Therefore the improper integral does not exist.

(b). Since  $f^2(x) \equiv 1$ , it is evident that the *Riemann integral* of  $f^2(x)$  exists. Let

$$P_N = \{0 = x_1, x_2, \dots, x_{N+1} = 1\}$$

be a *partition* of  $[0, 1]$  into equal subintervals. We can always choose a *rational* point,  $\xi_i$ , in each of the subintervals so that the Riemann sum

$$R(\xi_1, \xi_2, \dots, \xi_N) = \sum_{n=1}^N f(\xi_n) \frac{1}{N} = 1.$$

Likewise, can always choose an *irrational* point,  $\eta_i$ , in each of the subintervals so that the Riemann sum

$$R(\eta_1, \eta_2, \dots, \eta_N) = \sum_{n=1}^N f(\eta_n) \frac{1}{N} = -1.$$

It follows that  $f(x)$  is *not* Riemann integrable.

8. With  $P_0(x) = 1$  and  $P_1(x) = x$ , the normalization conditions are satisfied. Using the usual inner product on  $[-1, 1]$ ,

$$\int_{-1}^1 P_0(x)P_1(x)dx = 0$$

and hence the polynomials are also orthogonal. Let  $P_2(x) = a_2x^2 + a_1x + a_0$ . The normalization condition requires that  $a_2 + a_1 + a_0 = 1$ . For orthogonality, we need

$$\int_{-1}^1 (a_2x^2 + a_1x + a_0)dx = 0 \text{ and } \int_{-1}^1 x(a_2x^2 + a_1x + a_0)dx = 0.$$

It follows that  $a_2 = 3/2$ ,  $a_1 = 0$  and  $a_0 = -1/2$ . Hence  $P_2(x) = (3x^2 - 1)/2$ . Now let  $P_3(x) = a_3x^3 + a_2x^2 + a_1x + a_0$ . The coefficients must be chosen so that  $a_3 + a_2 + a_1 + a_0 = 1$  and the orthogonality conditions

$$\int_{-1}^1 P_i(x)P_j(x)dx = 0 \quad (i \neq j)$$

are satisfied. Solution of the resulting algebraic equations leads to  $a_3 = 5/2$ ,  $a_2 = 0$ ,  $a_1 = -3/2$  and  $a_0 = 0$ . Therefore  $P_3(x) = (5x^3 - 3x)/2$ .

11. The implied sequence of coefficients is  $a_n = 1$ ,  $n \geq 1$ . Since the limit of these coefficients is *not* zero, the series cannot be an eigenfunction expansion.

13. Consider the eigenfunction expansion

$$f(x) = \sum_{i=1}^{\infty} a_i \phi_i(x).$$

Formally,

$$f^2(x) = \sum_{i=1}^{\infty} a_i^2 \phi_i^2(x) + 2 \sum_{i \neq j} a_i a_j \phi_i(x) \phi_j(x).$$

Integrating term-by-term,

$$\begin{aligned} \int_0^1 r(x) f^2(x) dx &= \sum_{i=1}^{\infty} \int_0^1 a_i^2 r(x) \phi_i^2(x) dx + 2 \sum_{i \neq j} \int_0^1 a_i a_j r(x) \phi_i(x) \phi_j(x) dx \\ &= \sum_{i=1}^{\infty} a_i^2 \int_0^1 \phi_i^2(x) dx, \end{aligned}$$

since the eigenfunctions are orthogonal. Assuming that they are also normalized,

$$\int_0^1 r(x) f^2(x) dx = \sum_{i=1}^{\infty} a_i^2.$$